



## Kalendáre, diáre a novoročenky 2



Nástenné kalendáre	2
Stolové kalendáre	20
Kalendáre s hodinami	24
Viacmesačné kalendáre	26
Obaly na kalendáre a diáre	28
Diáre	29
Novoročenky, vianočné CD	34

## PC doplnky, kalkulačky 112



USB kľúče	112
Lasery, príslušenstvo k PC	118
Kalkulačky	119

## Čiapky, šály, klobúky, rukavice 182



Klobúky, šatky	182
Baseballové čiapky	183
Zimné čiapky, rukavice a flisové sady	186

## Domacia pohoda 246



Aróma sady, relaxačné darčeky, čaje	246
Kuchyňa a grilovanie	248
Piknikové sady, termotašky, šálky	254
Príslušenstvo k vínu	256
Fľaše na nápoje, poháre, hrnčeky	260
Keramické hrnčeky	262

## Parker, Waterman, Lamy, Quill 38



Jotter	38
Vector	39
Urban	40
Parker IM	42
Ingenuity	44
Quill, Lamy	46
Waterman	47

## Meranie času a teploty 122



Teplomery a meteorostanice	122
Stolové hodiny, budíky	124
Hodinky	128
Nástenné hodiny	130

## Dáždniky a príšiplášte 189



Príšiplášte	189
Skladacie dáždniky	190
Dáždniky s pevnou rukoväťou	195

## Fľašky, termosky, termohrnčeky 266



Termohrnčeky a termokovčinky	266
Termosky, kovové hrnčeky	267
Fľašky, líkérky	269

## Písacie potreby 48



Plastové guľičkové perá	48
Kovové perá a rollery, mechanické ceruzky	57
Multifunkčné perá	66
Sady písacích potrieb, perá v krabičkách	68
Drevené perá a ceruzky	80

## Baterky, náradie, hobby 132



Baterky, čelovky, blikáčky	132
Autodoplnky, alkoholtestery	136
Multifunkčné náradie, sady náradia, skladacie metre	138
Drobné náradie, rezače a metre	142

## Tašky, rucksaky, cestovná batožina 200



Papierové tašky	200
Tašky na víno	203
Nákupné tašky	204
Koše a rucksaky	206
Drobnosti a doplnky na cesty	210
Športové a cestovné tašky	212

## Zapaľovače a popolníky 272



Orezávač cigár, popolníky	272
Krbové zapaľovače	273
Kovové zapaľovače	274
Plastové zapaľovače	276

## Kancelária 82



Držáky ceruziek	82
Bloky, stojany na mobil	83
Kancelárske drobnosti a lepiace lístky	86
Kovové vizitkare	88
Čističe okuliarov a displejov	90
Obaly a doplnky pre mobily, iPhone a iPady	91

## Darčeky pre deti 144



Darčeky pre deti	144
------------------	-----

## Kongresové tašky a aktovky 216



Kongresové tašky	216
Spisovky a mapy na dokumenty	220
Aktovky, kufriky	222

## Šnúry na krk 278



Šnúry na krk	278
--------------	-----

## Drobné darčeky 92



Kovové zetóny a privesky	92
Štylové a multifunkčné privesky	94
Plastové zetóny, privesky	98
Otvárače na fľaše, vývrtky	100
Nože a dýky	102

## Šport, hry a voľný čas 148



Stolové a spoločenské hry	148
Outdoor, golf, pétanque	151
Flisové deky	153
Fitness darčeky, krokometry, fľaše na nápoje	154
Rozlišovacie dresy, letné darčeky	155
Darčeky pre fanúšikov	156

## Peňaženky, dokladovky 224



Darčkové sady peňaženiek	224
Peňaženky a dokladovky	225
Obaly na CD a DVD	233

## Sladká reklama 281



Cukríky na zákazku, balený cukor	281
Cukríky, lentiľky	282
Clík Clak	284

## Victorinox 107



SwissCard	107
Victorinox nože	108

## Reklamný textil 158



Pánske, dámske a detské tričky	158
Polokošeľa, trička s golierom	165
Mikiny a flis	170
Bundy a vesty	175

## Drobnosti osobnej potreby 234



Hygienické a kozmetické potreby	234
Osušky, uteráky, župany	236
Kravyaty, manžetové gombíky	238
Sady do kúpeľa	239
Praktické darčeky, toaletné tašky	240
Zrkadielka, manikúry	242

## Potlač 285



Cenníky tlačových technológií	285
Spoločné podmienky potlače	288

V katalógu sú okrem iných ponúkané reklamné predmety týchto značiek:

Paul Bourne

SWAROVSKI  
ELEMENTS

SamsOnite

MARKS &amp; SPENCER

COLE &amp; MASON

andré philippe

DUNLOP

Slazenger

WATERMAN  
PARIS

LAMY

BOSCH

erga

BALMAIN  
PARIS

JOURNALBOOKS

Alexluca  
Italy

Safebrella®

US BASIC  
CLASSIC PAPER MIX

VICTORINOX

PARKER

Quill

Jamie  
Oliver

LAGUIOLE®

BRAIN  
STREAM

Lipton

PICKWICK

ELEVATE

FARE

JAMES &  
NICHOLSON  
FASHION TUNES  
TODDnode®

Všetky ceny sú uvedené za jeden kus v € bez DPH, bez potlače (pokiaľ nie je pri tovare uvedené inak) a bez nákladov na balenie a expedíciu.

Ceny znižujúce sa v závislosti na množstve objednaných kusov platia pre každý objednávaci kód samostatne, nie je možné ich zlučovať, napríklad súčtom rôznych farieb či veľkostí.

Expedičné náklady sa klientom účtujú vždy, teda aj pri prípadnom zapožičaní vzoriek. Ak atypické rozmery či váha tovaru vyvolajú expedičné náklady vyššie, ako sú bežne kalkulované, vyhradzuje si Dodávateľ právo doúčtovať náklady v ich skutočnej výške.

Dodávateľ si vyhradzuje právo zmeniť ceny, alebo ponúkaný sortiment, pokiaľ si to vyžadujú výrazné kurzové zmeny, dovozné príhrážky alebo podmienky výrobcov.

Platobné a dodacie podmienky sa riadia Obchodnými podmienkami Dodávateľa, ktoré sú Kupujúcemu k dispozícii v sídle Dodávateľa, alebo na jeho webových stránkach.

Fotografie jednotlivých predmetov majú len informatívny charakter a nemusia celkom zodpovedať skutočnosti. Týka sa to hlavne farebnosti a detailov prevedenia.

Použité logá a názvy sú registrovanými obchodnými značkami uvedených spoločností a sú na predmetoch znázornené len pre ilustráciu potlače.

Obaly uvádzané na trh v rámci tohto katalógu spĺňajú požiadavky zákona č. 223/2001 Z. z. (v aktuálnom znení podľa neskorších predpisov). Uvedené ceny tovaru neobsahujú príspevky na likvidáciu elektrozariadení podľa zákona č. 733/2004 Z. z. o odpadoch (v aktuálnom znení podľa neskorších predpisov).

Tlačové chyby vyhradené.

# Nová značka textilu v našom katalógu



ELEVATE



Predstavujeme vám úplne novú značku vysoko kvalitného textilu – ELEVATE. Kanadská značka ELEVATE bola uvedená na trh v roku 2006. Táto kolekcia textilu v sebe spojila inovatívne tkaniny s mestským štýlom, ktorý odráža dizajnové novinky a vysokou kvalitou spracovania.

Elevate vtrhla na svetovú scénu v roku 2010, ako oficiálny dodávateľ Zimných olympijských hier vo Vancouveri, kde predstavila svoj špičkový dizajn a univerzálnu príťažlivosť. Napriek tomu, že má svoje korene v Kanade, Elevate postupne dobíja trhy po celom svete a práve vstúpila na európsky trh.

Elevate si ctí osvedčené konštrukčné metódy a moderné tkaniny, navrhnuté pre maximálny komfort a dlhú životnosť. Táto prirodzená kolekcia vyvažuje módnú kombináciu trendov do mesta i do prírody.

62600

**SALVADOR DALÍ**  
neutrálne kalendárium

420 x 560 mm  
sietotlač, digitálna tlač  
horná reklamná plocha (lišta): 420 x 60 mm

ks	1-29	30+	120+	360+
€	8,770	8,419	8,068	7,893

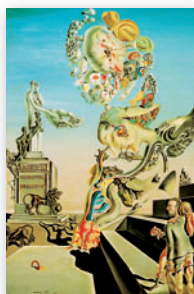
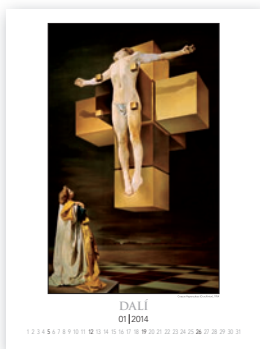

62601

**IMPRESSIONISTS**  
neutrálne kalendárium

420 x 560 mm  
sietotlač, digitálna tlač  
horná reklamná plocha (lišta): 420 x 60 mm

ks	1-29	30+	120+	360+
€	8,210	7,882	7,553	7,389

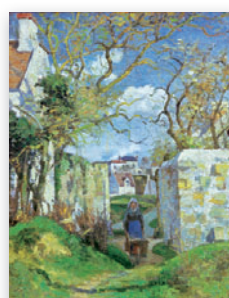
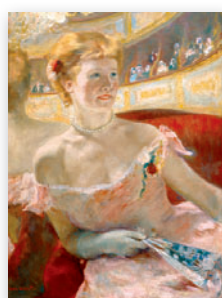
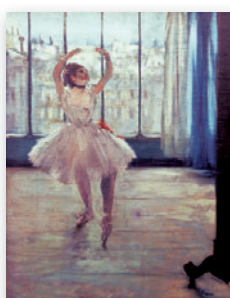
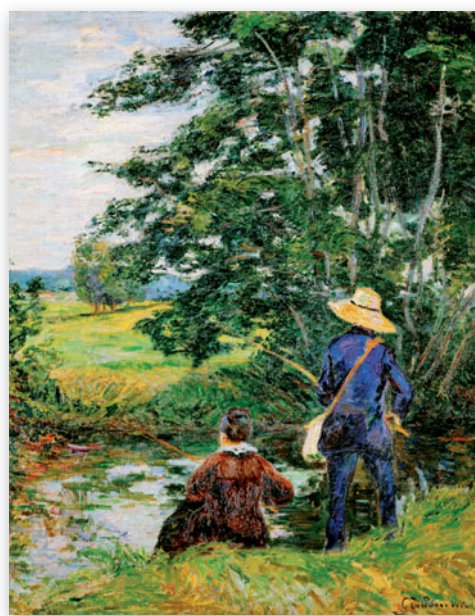
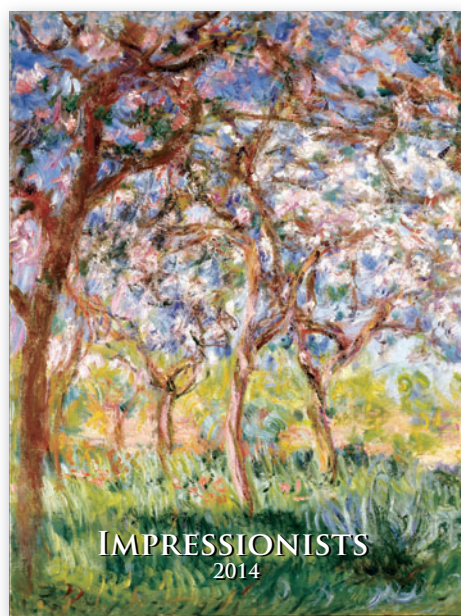
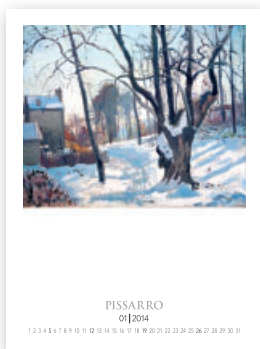

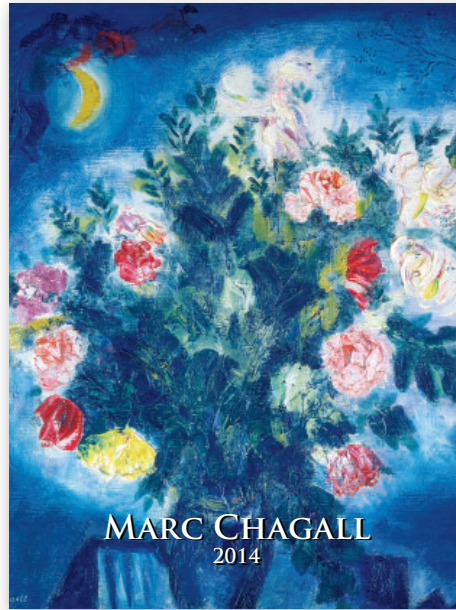

62676  
MARC CHAGALL  
neutrálne kalendárium

420 x 560 mm  
sieťotlač, digitálna tlač  
horná reklamná plocha (líšta): 420 x 60 mm

ks	1-29	30+	120+	360+
€	8,217	8,000	7,783	7,348

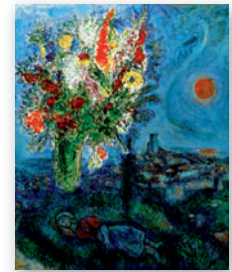
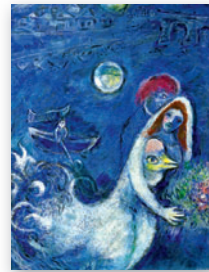
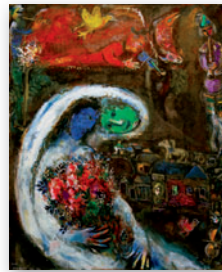
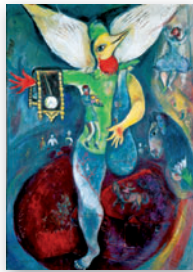
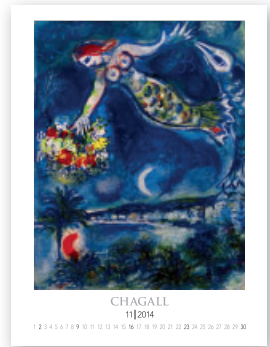

62675  
NAIVE ART  
neutrálne kalendárium

novinka

485 x 340 mm  
sieťotlač, digitálna tlač  
horná reklamná plocha (líšta): 485 x 60 mm

ks	1-29	30+	120+	360+
€	7,210	6,922	6,633	6,489

Farebne výrazná sedemfarebná tlač



62619

**ANTIQUÉ MAPS**  
neutrálne kalendárium

420 x 420 mm  
sieťotlač, digitálna tlač  
horná reklamná plocha (líšta): 420 x 60 mm

ks	1-29	30+	120+	360+
€	6,200	5,952	5,704	5,580



62671

**FLOWER DESIGN**  
neutrálne kalendárium

novinka

420 x 420 mm  
sieťotlač, digitálna tlač  
horná reklamná plocha (líšta): 420 x 60 mm

ks	1-29	30+	120+	360+
€	6,200	5,952	5,704	5,580

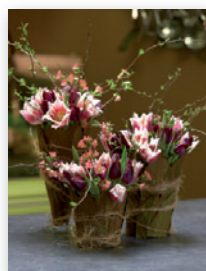



62684

VÍNO  
neutrálne kalendárium

340 x 325 mm  
sieťotlač, digitálna tlač  
horná reklamná plocha (líšta): 340 x 60 mm

ks	1-49	50+	200+	600+
€	4,304	4,130	4,000	3,870



62695

MIXTA  
neutrálne kalendárium

novinka

485 x 340 mm  
sieťotlač, digitálna tlač  
horná reklamná plocha (líšta): 485 x 60 mm

ks	1-39	40+	160+	480+
€	5,609	5,391	5,174	5,043

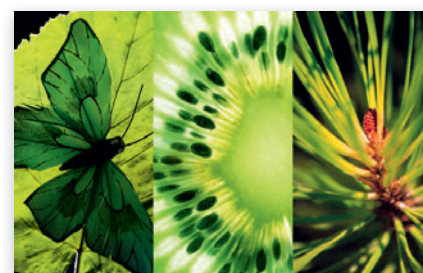

62610

**WORLD ARCHITECTURE**  
neutrálne/anglické  
kalendárium

nový  
formát

420 x 420 mm  
sietotlač, digitálna tlač  
horná reklamná plocha (líšta): 420 x 60 mm

ks	1-29	30+	120+	360+
€	6,200	5,952	5,704	5,580

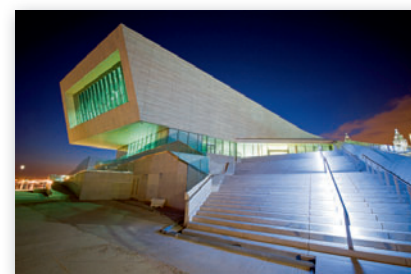
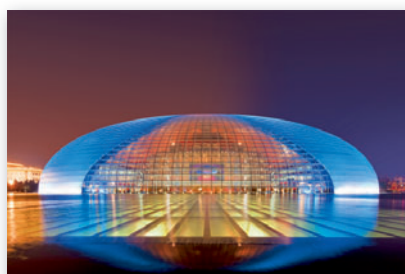

62658

**WORLD WONDERS**  
neutrálne/anglické  
kalendárium

novinka

485 x 340 mm  
sietotlač, digitálna tlač  
horná reklamná plocha (líšta): 485 x 60 mm

ks	1-39	40+	160+	480+
€	5,609	5,391	5,174	5,043

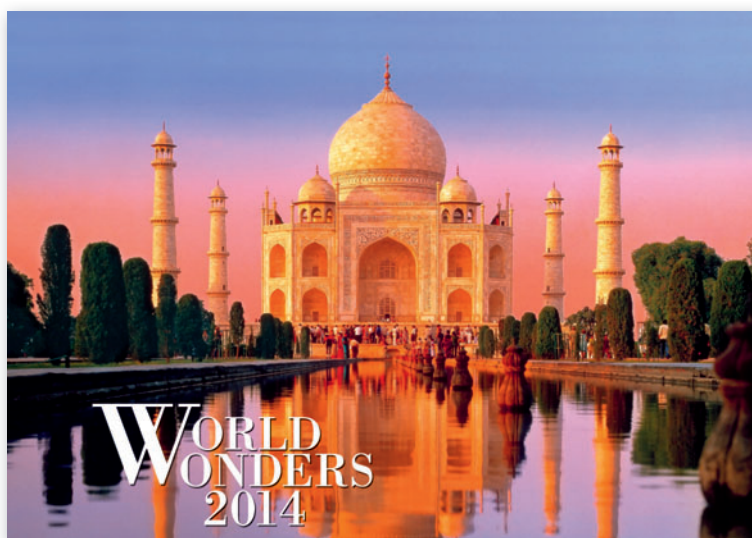





62608

**EUROPE**  
neutrálne kalendárium

340 x 485 mm  
sieťotlač, digitálna tlač  
horná reklamná plocha (líšta): 340 x 60 mm

ks	1-39	40+	160+	480+
€	5,500	5,280	5,060	4,950



62669

**BRIDGES**  
neutrálne kalendárium

485 x 340 mm  
sieťotlač, digitálna tlač  
horná reklamná plocha (líšta): 485 x 60 mm

ks	1-39	40+	160+	480+
€	5,174	4,957	4,783	4,652

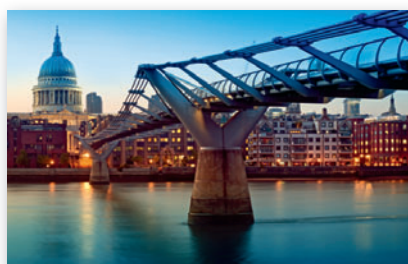

63606

**KRÁSY HÔR**  
slovenské kalendárium

340 x 485 mm  
sieťotlač, digitálna tlač  
horná reklamná plocha (líšta): 340 x 60 mm

ks	1-39	40+	160+	480+
€	5,400	5,184	4,968	4,860

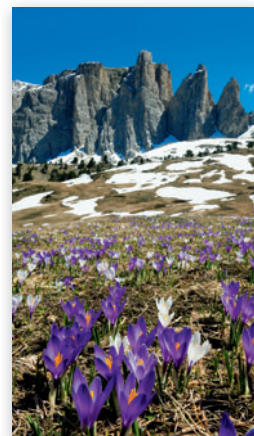
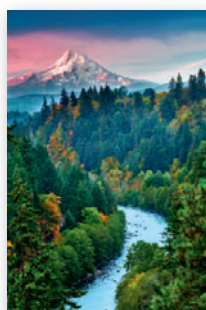
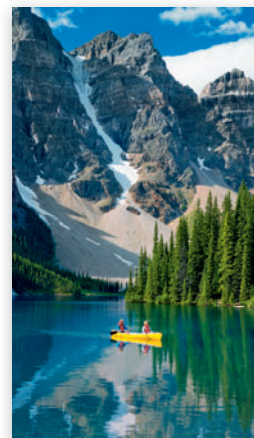

64604

**TATRY**  
slovenské kalendárium

330 x 330 mm  
sieťotlač, digitálna tlač  
horná reklamná plocha (líšta): 330 x 60 mm

ks	1-49	50+	200+	600+
€	4,540	4,358	4,177	4,086

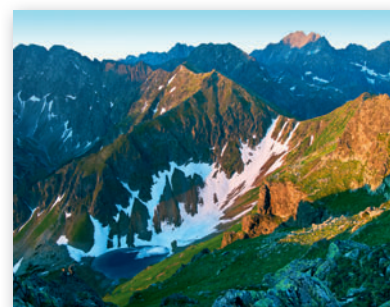
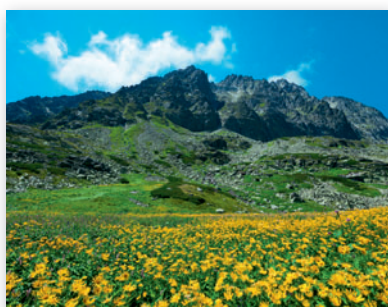
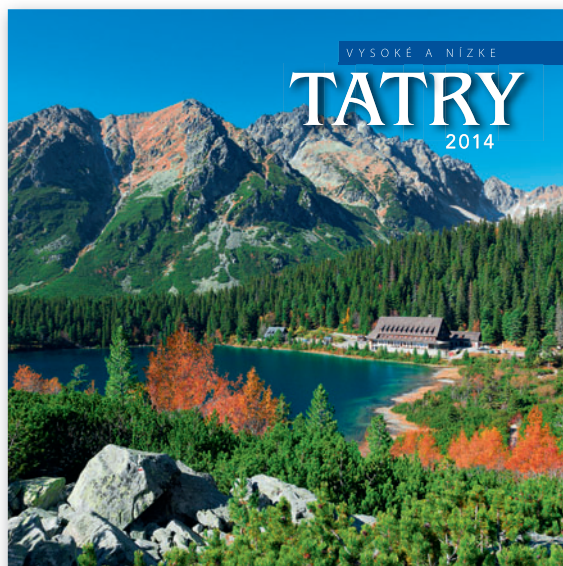



**64606**  
**SLOVENSKO**  
**slovenské kalendárium**

340 x 485 mm  
sieťotlač, digitálna tlač  
horná reklamná plocha (líšta): 340 x 60 mm

ks	1-39	40+	160+	480+
€	5,540	5,318	5,097	4,986

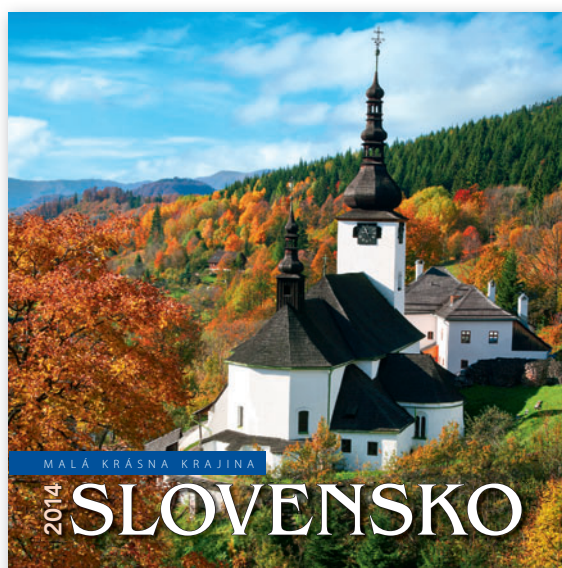

**64605**  
**SLOVENSKO**  
**slovenské kalendárium**

330 x 330 mm  
sieťotlač, digitálna tlač  
horná reklamná plocha (líšta): 330 x 60 mm

ks	1-49	50+	200+	600+
€	4,540	4,358	4,177	4,086



63607

**SVET TICHÁ**  
slovenské kalendárium

330 x 330 mm  
sietotlač, digitálna tlač  
horná reklamná plocha (lišta): 330 x 60 mm

ks	1-49	50+	200+	600+
€	4,540	4,358	4,177	4,086



63617

**ZÁHRADY**  
slovenské kalendárium

330 x 330 mm  
sietotlač, digitálna tlač  
horná reklamná plocha (lišta): 330 x 60 mm

ks	1-49	50+	200+	600+
€	4,390	4,214	4,039	3,951

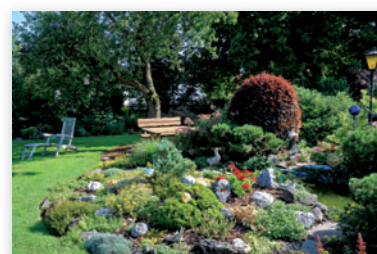
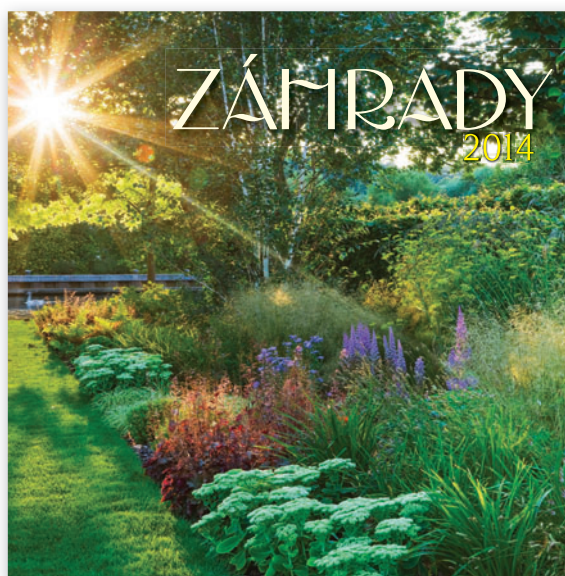

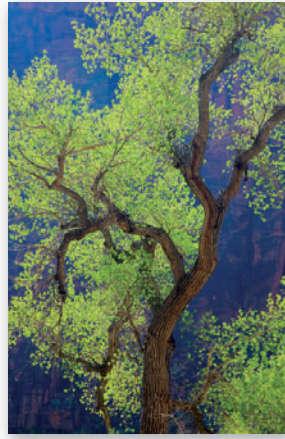

62674

**STROMY**  
neutrálne kalendárium

330 x 600 mm  
sieťotlač, digitálna tlač  
horná reklamná plocha (líšta): 330 x 60 mm

ks	1-29	30+	120+	360+
€	7,210	6,922	6,633	6,489



62649

**ALEJE**  
neutrálne kalendárium

485 x 340 mm  
sieťotlač, digitálna tlač  
horná reklamná plocha (líšta): 485 x 60 mm

ks	1-39	40+	160+	480+
€	5,500	5,280	5,060	4,950

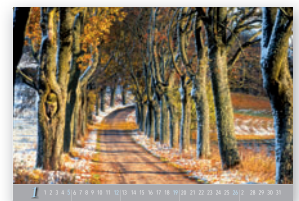

62625

**PANORAMAPHOTO**  
neutrálne kalendárium

630 x 315 mm  
sietotlač, digitálna tlač  
horná reklamná plocha (líšta): 630 x 60 mm

ks	1-29	30+	120+	360+
€	7,783	7,478	7,174	7,000

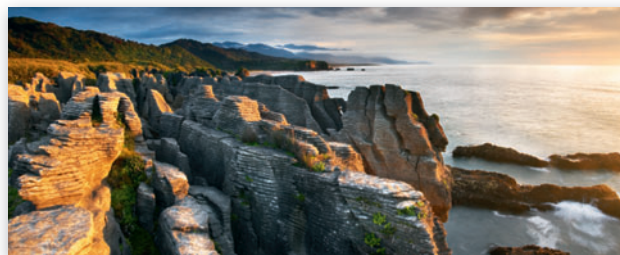

62656

**LANDSCAPES**  
neutrálne kalendárium

485 x 340 mm  
sietotlač, digitálna tlač  
horná reklamná plocha (líšta): 485 x 60 mm

ks	1-39	40+	160+	480+
€	5,609	5,391	5,174	5,043

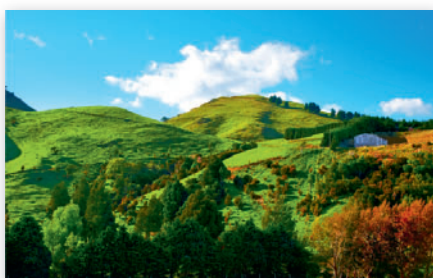



62659

VIA  
neutrálne kalendárium

485 x 340 mm  
sieťotlač, digitálna tlač  
horná reklamná plocha (líšta): 485 x 60 mm

ks	1-39	40+	160+	480+
€	5,609	5,391	5,174	5,043



62633

NATIONAL PARKS  
neutrálne kalendárium

485 x 340 mm  
sieťotlač, digitálna tlač  
horná reklamná plocha (líšta): 485 x 60 mm

ks	1-39	40+	160+	480+
€	5,609	5,391	5,174	5,043



62678

**GEOGRAPHICA**  
neutrálne kalendárium

420 x 560 mm  
sietotlač, digitálna tlač  
horná reklamná plocha (líšta): 420 x 60 mm

ks	1-29	30+	120+	360+
€	8,430	8,093	7,756	7,587

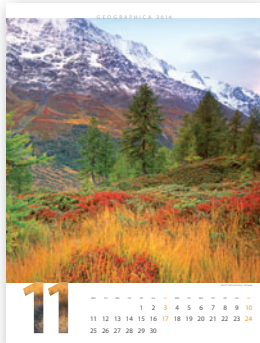

62611

**NATURE ELEMENTS**  
neutrálne kalendárium

485 x 340 mm  
sietotlač, digitálna tlač  
horná reklamná plocha (líšta): 485 x 60 mm

ks	1-39	40+	160+	480+
€	5,609	5,391	5,174	5,043

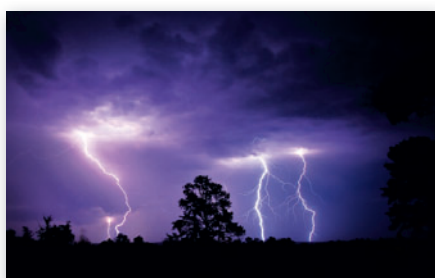



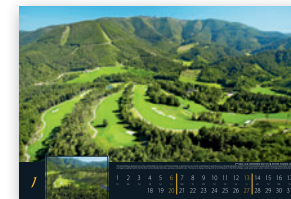
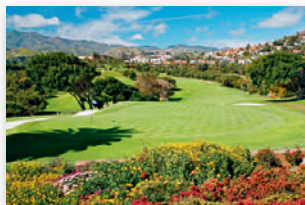

62665

**GOLF**  
neutrálne kalendárium

485 x 340 mm  
sieťotlač, digitálna tlač  
horná reklamná plocha (líšta): 485 x 60 mm

ks	1-39	40+	160+	480+
€	5,670	5,443	5,216	5,103

63648

**POĽOVNÍCKY**  
slovenské kalendárium

340 x 485 mm  
sieťotlač, digitálna tlač  
horná reklamná plocha (líšta): 340 x 60 mm

ks	1-39	40+	160+	480+
€	5,400	5,184	4,968	4,860

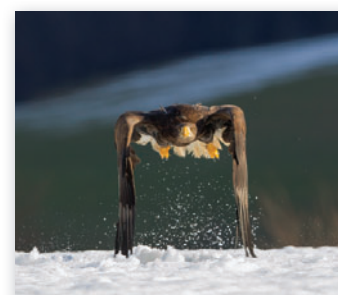
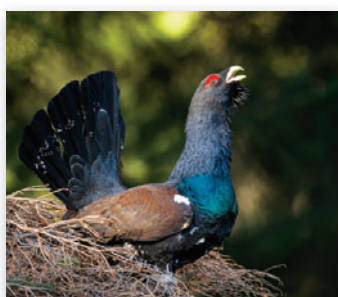

62664

**FORCE 10**  
neutrálne/anglické  
kalendárium

novinka

420 x 420 mm  
sieťotlač, digitálna tlač  
horná reklamná plocha (líšta): 420 x 60 mm

ks	1-29	30+	120+	360+
€	6,200	5,952	5,704	5,580



62687

**TRUCKS**  
neutrálne kalendárium

485 x 340 mm  
sieťotlač, digitálna tlač  
horná reklamná plocha (líšta): 485 x 60 mm

ks	1-39	40+	160+	480+
€	5,540	5,318	5,097	4,986





**62623**  
**EROTIC MOMENTS**  
neutrálne kalendárium

420 x 560 mm  
sieťotlač, digitálna tlač  
horná reklamná plocha (líšta): 420 x 60 mm

ks	1-29	30+	120+	360+
€	8,550	8,208	7,866	7,695

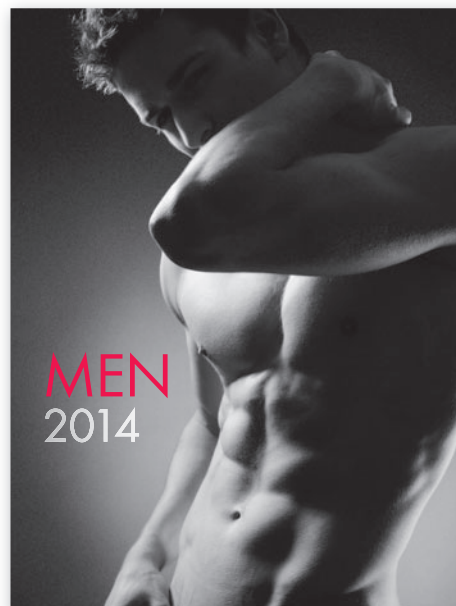
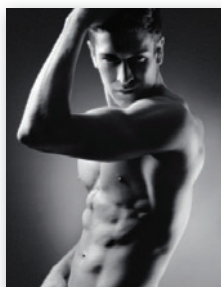
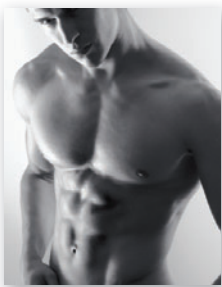
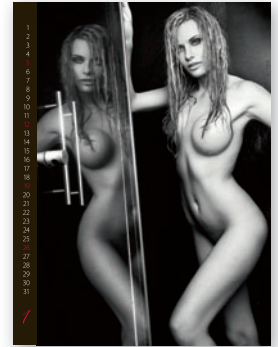

**62668**  
**MEN**  
neutrálne kalendárium

420 x 560 mm  
sieťotlač, digitálna tlač  
horná reklamná plocha (líšta): 420 x 60 mm

ks	1-29	30+	120+	360+
€	8,550	8,208	7,866	7,695

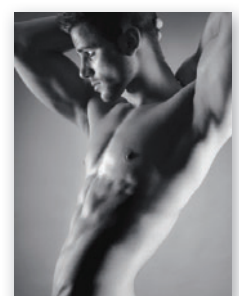
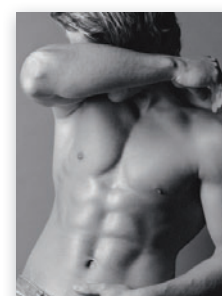
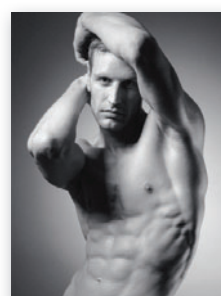
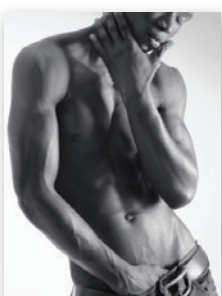
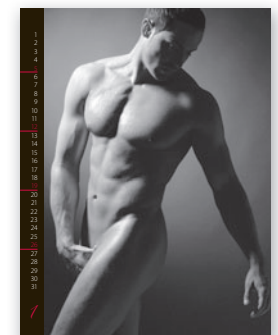
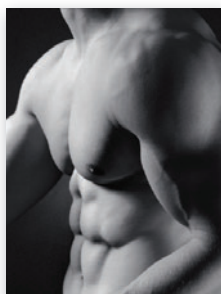

62629

**DREAM GIRLS**  
neutrálne kalendárium

340 x 485 mm  
sieťotlač, digitálna tlač  
horná reklamná plocha (líšta): 340 x 60 mm

ks	1-39	40+	160+	480+
€	5,540	5,318	5,097	4,986

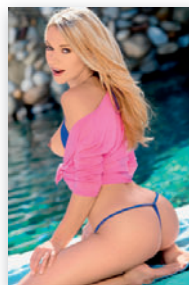
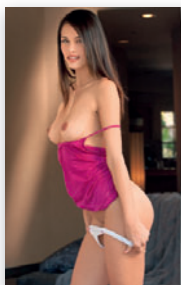

62631

**EXCLUSIVE GIRLS**  
neutrálne kalendárium

330 x 330 mm  
sieťotlač, digitálna tlač  
horná reklamná plocha (líšta): 330 x 60 mm

ks	1-59	60+	240+	720+
€	4,650	4,464	4,278	4,185





62632  
PLAYBOY  
neutrálne kalendárium

340 x 485 mm  
sieťotlač, digitálna tlač  
horná reklamná plocha (líšta): 340 x 60 mm

ks	1-19	20+	100+	300+
€	9,348	9,000	8,652	8,435

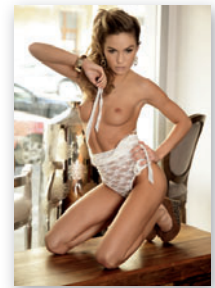
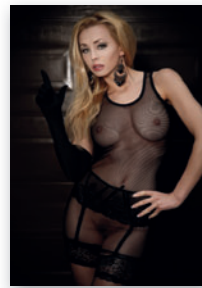
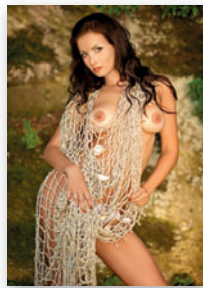
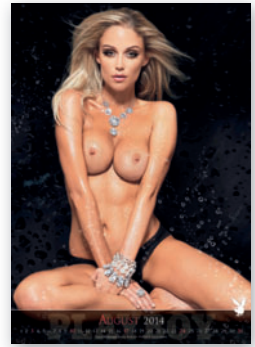

62682  
PURE  
neutrálne kalendárium

485 x 340 mm  
sieťotlač, digitálna tlač  
horná reklamná plocha (líšta): 485 x 60 mm

ks	1-39	40+	160+	480+
€	5,670	5,443	5,216	5,103

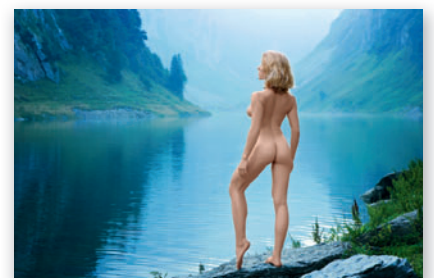
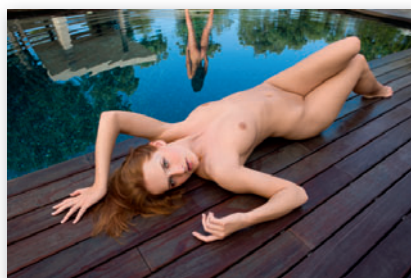
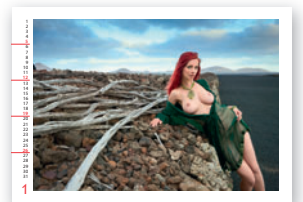

63753

**POÉZIA PRÍRODY**  
stolový kalendár  
slovenské kalendárium

297 x 138 mm (kalendárium)  
sieťotlač, digitálna tlač

ks	1-59	60+	300+	600+
€	2,210	2,122	2,033	1,989



dve reklamné plochy 297 x 30 mm

64704

**LOVU ZDAR**  
stolový kalendár  
slovenské kalendárium

297 x 138 mm (kalendárium)  
sieťotlač, digitálna tlač

ks	1-59	60+	300+	600+
€	2,660	2,554	2,447	2,394



dve reklamné plochy 297 x 30 mm

64705

**ZDRAVIE Z PRÍRODY**  
stolový kalendár  
slovenské kalendárium

230 x 140 mm (kalendárium)  
sieťotlač, digitálna tlač

ks	1-59	60+	300+	600+
€	2,210	2,122	2,033	1,989



dve reklamné plochy 230 x 30 mm

64701

SLOVENSKO I.  
stolový stĺpcový kalendár  
slovenské kalendárium

297 x 138 mm (kalendárium)  
sieťotlač, digitálna tlač

ks	1-59	60+	300+	600+
€	2,400	2,304	2,208	2,160



64702

SLOVENSKO II.  
stolový riadkový kalendár  
slovenské kalendárium

297 x 138 mm (kalendárium)  
sieťotlač, digitálna tlač

ks	1-59	60+	300+	600+
€	2,400	2,304	2,208	2,160



64703

TATRY  
stolový stĺpcový kalendár  
slovenské kalendárium

297 x 138 mm (kalendárium)  
sieťotlač, digitálna tlač

ks	1-59	60+	300+	600+
€	2,400	2,304	2,208	2,160





62754

GIRLS  
stolový kalendár  
české/slovenské kalendárium

226 x 139 mm (kalendárium)  
sieťotlač, digitálna tlač

ks	1-59	60+	300+	600+
€	2,565	2,478	2,391	2,304



dve reklamné plochy 226 x 30 mm

64707

KUCHÁRKA  
stolový kalendár  
slovenské kalendárium

297 x 138 mm (kalendárium)  
sieťotlač, digitálna tlač

ks	1-59	60+	300+	600+
€	2,290	2,198	2,107	2,061



dve reklamné plochy 297 x 30 mm

63751

AUTOKALENDÁR  
stolový kalendár  
slovenské kalendárium

297 x 138 mm (kalendárium)  
sieťotlač, digitálna tlač

ks	1-59	60+	300+	600+
€	2,660	2,554	2,447	2,394



dve reklamné plochy 297 x 30 mm





64711

**PLÁNOVACÍ KALENDÁŘ**  
stolový kalendár  
slovenské kalendárium

297 x 138 mm (kalendárium)  
sietotlač, digitálna tlač

ks	1-59	60+	300+	600+
€	1,790	1,718	1,647	1,611



Stolové týždenné pracovné kalendáre **PLÁNOVACÍ** a **MAXI** obsahujú rozšírené menné kalendárium a daňové povinnosti.



64712

**PLÁNOVACÍ MAXI**  
stolový kalendár  
slovenské kalendárium

297 x 180 mm (kalendárium)  
sietotlač, digitálna tlač

ks	1-59	60+	300+	600+
€	1,880	1,805	1,730	1,692



# Kalendáře s hodinami

62730

**HARMONIE BAREV**  
nástenný kalendář s hodinami  
neutrálné kalendárium

350 x 350 mm  
sieťotlač, digitálna tlač  
spodná reklamná plocha (líšta): 350 x 70 mm

10,522



Potlačený podkladový kartón bez kalendária môže po uplynutí roka ďalej slúžiť ako dizajnové hodiny.



reklamná plocha 350 x 70 mm

Súčasťou kalendára je hodinový strojček vrátane tužkovej batérie a návodu na montáž strojčeka. Strojček tu slúži ako závesný prvok.



všetko  
novinky

62731

**MAGICKÉ KRAJINY**  
nástenný kalendář s hodinami  
neutrálné kalendárium

350 x 350 mm  
sieťotlač, digitálna tlač  
spodná reklamná plocha (líšta): 350 x 70 mm

10,391



Potlačený podkladový kartón bez kalendária môže po uplynutí roka ďalej slúžiť ako dizajnové hodiny.



reklamná plocha 350 x 70 mm

Súčasťou kalendára je hodinový strojček vrátane tužkovej batérie a návodu na montáž strojčeka. Strojček tu slúži ako závesný prvok.



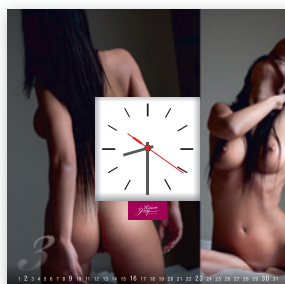

reklamná plocha 350 x 70 mm

62732

**KRÁSA ŽENY**  
nástenný kalendář s hodinami  
neutrálne kalendárium

350 x 350 mm  
sieťotlač, digitálna tlač  
spodná reklamná plocha (líšta): 350 x 70 mm

**10,<sup>957</sup>**

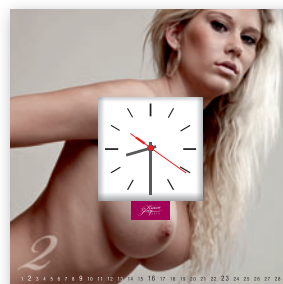

Potlačení podkladový kartón bez kalendária môže po uplynutí roka ďalej slúžiť ako dizajnové hodiny.

Súčasťou kalendára je hodinový strojček vrátane tužkovej batérie a návodu na montáž strojčeka. Strojček tu slúži ako závesný prvok.

všetko  
novinky



62763

**PRACOVNÝ stolový**  
týždenný kalendář s hodinami  
české/slovenské kalendárium

330 x 160 mm  
210 x 130 mm (kalendárium)  
sieťotlač, digitálna tlač

**5,<sup>348</sup>**

Nástenné a stolové kalendáře s hodinami dodávame v nezmontovanom stave.



Súčasťou kalendára je hodinový strojček vrátane tužkovej batérie a návodu na montáž strojčeka.

Po uplynutí roka môžete hodiny odstrihnúť a používať ich ďalej samostatne.

64692

**TRIO SPIRA SIVÝ**  
viacjazyčné kalendárium

295 x 870 mm  
sieťotlač, ofset

ks	1-49	50+	200+	600+
€	4,190	4,022	3,855	3,771

Rozsah: 3 x 12 listov  
Kalendárium: slovensky, anglicky,  
nemecky, francúzsky  
Väzba: 1x šitá s perforáciou, 2x špirála

64693

**TRIO SPIRA MODRÝ**  
viacjazyčné kalendárium

295 x 870 mm  
sieťotlač, ofset

ks	1-49	50+	200+	600+
€	4,190	4,022	3,855	3,771

Kalendár je možné dodať aj s obrázkom podľa želania klienta. Cena sa kalkuluje individuálne v závislosti od množstva a materiálových požiadaviek zákazky. Orientačné ceny nájdate v cenníku potlačí.

reklamná plocha 295 x 180 mm

reklamná plocha 295 x 60 mm



reklamná plocha 295 x 180 mm

reklamná plocha 295 x 60 mm



64906.F  
Lišta s obrázkom  
295 x 180 mm

ks	1-59	60+	300+	600+
€	0,660	0,634	0,608	0,584

64921.X  
Lišta s obrázkom  
295 x 180 mm

ks	1-59	60+	300+	600+
€	0,660	0,634	0,608	0,584



295 x 475 mm  
sietotlač, ofset

ks	1-59	60+	300+	600+
€	1,950	1,872	1,797	1,725

63712  
SPEDIT BLUE  
SK/A/N kalendárium

reklamná plocha 295 x 150 mm

DECEMBER	DECEMBER 2013	DECEMBER
48		1
49	2 3 4 5 6 7 8	
50	9 10 11 12 13 14 15	
51	16 17 18 19 20 21 22	
52	23/30 24/31 25 26 27 28 29	

JANUARY	JANUÁR 2014	JANUAR
1	1 2 3 4 5	
2	6 7 8 9 10 11 12	
3	13 14 15 16 17 18 19	
4	20 21 22 23 24 25 26	
5	27 28 29 30 31	

FEBRUARY	FEBRUÁR 2014	FEBRUAR
		1 2
	3 4 5 6 7 8 9	
	10 11 12 13 14 15 16	
	17 18 19 20 21 22 23	
	24 25 26 27 28	

reklamná plocha 295 x 55 mm

**Január 2014**

Po	6 13 20 27
Ut	7 14 21 28
St	1 8 15 22 29
Št	2 9 16 23 30
Pi	3 10 17 24 31
So	4 11 18 25
Ne	5 12 19 26
	1 2 3 4 5

63713  
SPEDIT GREY  
SK/A/N kalendárium

reklamná plocha 295 x 150 mm

DECEMBER	DECEMBER 2013	DECEMBER
48		1
49	2 3 4 5 6 7 8	
50	9 10 11 12 13 14 15	
51	16 17 18 19 20 21 22	
52	23/30 24/31 25 26 27 28 29	

Nový rok, Deň vzniku SR

JANUARY	JANUÁR 2014	JANUAR
1	1 2 3 4 5	
2	6 7 8 9 10 11 12	
3	13 14 15 16 17 18 19	
4	20 21 22 23 24 25 26	
5	27 28 29 30 31	

FEBRUARY	FEBRUÁR 2014	FEBRUAR
5		1 2
6	3 4 5 6 7 8 9	
7	10 11 12 13 14 15 16	
8	17 18 19 20 21 22 23	
9	24 25 26 27 28	

reklamná plocha 295 x 55 mm

Rozsah 12 listov  
Sviatky susedných krajín, slovenské sviatky a mená  
Kalendárium: slovensky, anglicky a nemecky



64908.Y  
Lišta s obrázkom  
295 x 180 mm

JANUARY	JANUÁR 2014	JANUAR
1	1 2 3 4 5	
2	6 7 8 9 10 11 12	
3	13 14 15 16 17 18 19	
4	20 21 22 23 24 25 26	
5	27 28 29 30 31	

FEBRUARY	FEBRUÁR 2014	FEBRUAR
		1 2
	3 4 5 6 7 8 9	
	10 11 12 13 14 15 16	
	17 18 19 20 21 22 23	
	24 25 26 27 28	

ks	1-59	60+	300+	600+
€	0,660	0,634	0,608	0,584

64920.X  
Lišta s obrázkom  
295 x 180 mm

ks	1-59	60+	300+	600+
€	0,660	0,634	0,608	0,584



DECEMBER	DECEMBER 2013	DECEMBER
48		1
49	2 3 4 5 6 7 8	
50	9 10 11 12 13 14 15	
51	16 17 18 19 20 21 22	
52	23/30 24/31 25 26 27 28 29	

JANUARY	JANUÁR 2014	JANUAR
1	1 2 3 4 5	
2	6 7 8 9 10 11 12	

novinka



**64591.M**  
**MINIDIÁR S ADRESÁROM**  
**slovenské kalendárium**

75 x 150 mm  
 sieťotlač, ofset

ks	1-199	200+	800+	1600+
€	1,300	1,248	1,196	1,151

Mesačný minidiár s adresárom v PVC obale, vhodný pre dekoráciu tampoprintom a sieťotlačou. Slovenské kalendárium s menami, celý mesiac prehľadne na dvojstrane, 48 strán na bielom papieri.



92104



Obaly na nástenné kalendáre			
kód	rozmer (mm)	vhodné pre rozmery kalendárov (mm)	cena
92101	350 x 390	330 x 330, 340 x 325	0,939
92102	440 x 580	420 x 420, 560 x 420, 485 x 340, 315 x 450	1,061
92103	490 x 620	330 x 600, 450 x 520	1,184
92104	700 x 385	630 x 315	1,429

Obaly sú dodávané v nezloženom stave, je ich možné potlačiť sieťotlačou.



630 x 315 mm



485 x 340 mm

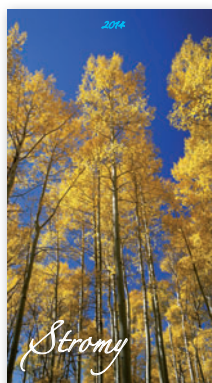

330 x 600 mm



330 x 330 mm

92101  
 92102  
 92103



Mesačný minidiár v PVC obale, vhodný pre dekoráciu tampoprintom a sietotlačou.

Slovenské kalendárium s menami, celý mesiac prehľadne na dvojstrane, 48 strán na bielom papieri.

JANUÁR	TYŽDEN	2014
1 ST NOVÝ ROK, DEN VÝSTAVY SR	1	1
2 ST ALEXANDRA, KARINA, KARIN		2
3 PI DAMIÁ A. BAPTIŠTA		3
4 SO ZLATOSLAV, TIVUS		4
5 NE ANDREA		5
6 PO TRÁH, KRÁU, ANTONIA	2	6
7 UT BOHDĽAVA		7
8 ST SEVERIN		8
9 ŠT ALEX, ALEXE		9
10 PI DÁŠA, DALMIL		10
11 SO MAJTEŇA		11
12 NE HENRIK, HENSTINA		12
13 PO RASTISLAV	3	13
14 UT RADOMAN, RADOMANA		14
15 ST DOMBOŠLAV		15
16 ŠT KRISTINA		16
17 PI SARÁŠA		17
18 SO BOHDANA		18
19 NE BRANIMIR, MARIS, SARA		19
20 PO EMILION, SEBASTIAN	4	20
21 UT YVONKA		21
22 ŠT ŽOŠA, ŽOŠAN, ŽOŠANA		22
23 ST MILOŠ		23
24 PI TIMOŠKA, TIMOŠKA		24
25 SO GYŠA		25
26 NE TAMARA		26
27 PO BOHUS	5	27
28 UT ALFONZ, ALFONZIA		28
29 ŠT CAROL		29
30 ŠT EMA, EMMA		30
31 PI EMIL		31

64593.C

MINIDIÁR ŠTANDARD  
slovenské kalendárium

75 x 150 mm  
sietotlač, ofset

ks	1-199	200+	800+	1600+
€	0,800	0,768	0,737	0,708

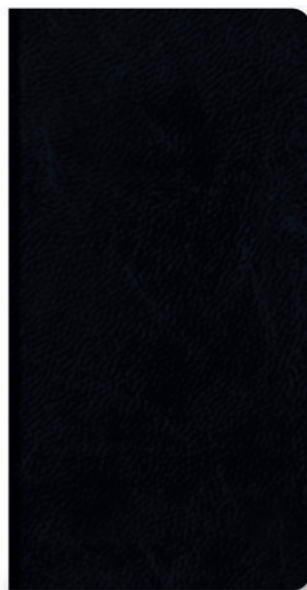

92110.B

Obal na vreckový diár

0,205



Obaly sú dodávané v nezloženom stave,  
je ich možné potlačiť sietotlačou.

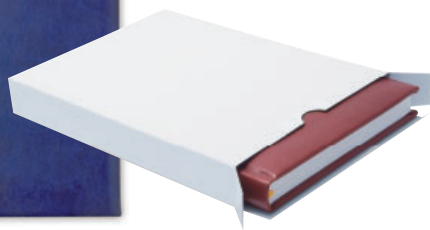

92111.B

Obal na denný diár A5

0,367

92112.B

Obal na týždenný diár B5

0,367



**MANAGER 2014**

Mäkký zamatovo matný povrch moderného diára s efektnou razbou v okolí chrbta a letopočtu v mnohých farebných variáciách umožňuje ľahkú aplikáciu loga razbou, sieťotlačou i tampoprintom. Štvorjazyčné kalendárium (čeština, slovenčina, angličtina a nemčina), menné sviatky Českej a Slovenskej republiky, osobné údaje, plánovací kalendár pre ČR a SR, bohaté infostrany, perforované rožky. Kvalitný svetlozltý papier, u denných diárov gramáže 70 g/m<sup>2</sup>, týždenných 90 g/m<sup>2</sup> a vreckových 60 g/m<sup>2</sup>. Denný a týždenný model obsahuje textilnú záložku. V zadnej časti denného diára je mapa A4 Českej a Slovenskej republiky a mapa A5 Európy, v zadnej časti týždenného diára je mapa B4 Českej a Slovenskej republiky a mapa B5 Európy.

**Týždenný diár B5**

174 x 246 mm

ks	1-39	40+	150+	400+
€	5,265	4,898	4,612	4,327

**Vreckový diár**

84 x 155 mm

ks	1-79	80+	300+	800+
€	2,327	2,204	2,082	1,959

oranžový

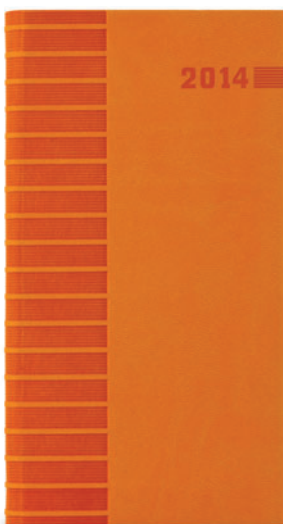

červený

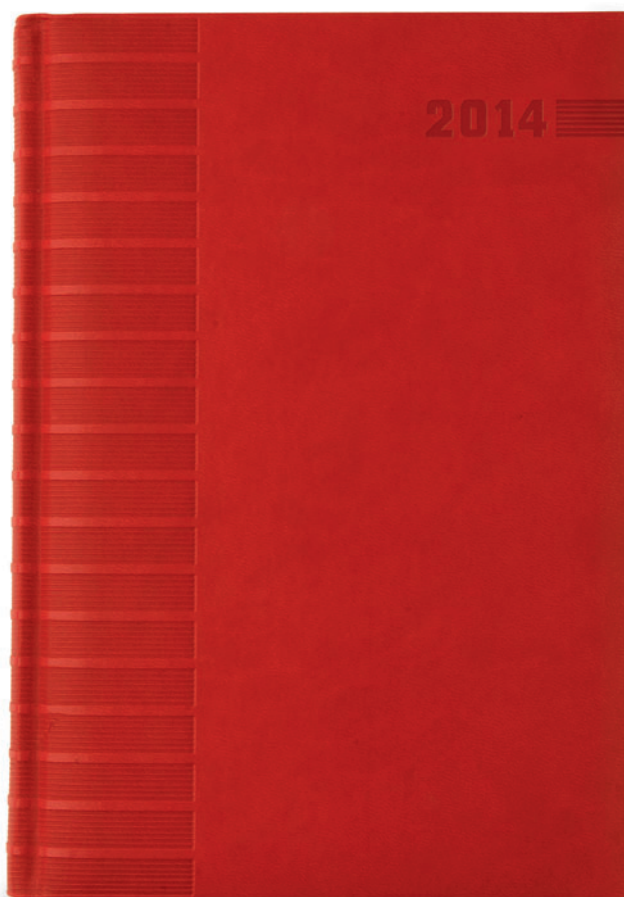

kalendárium vreckového diára



kalendárium týždenného diára B5





zelený

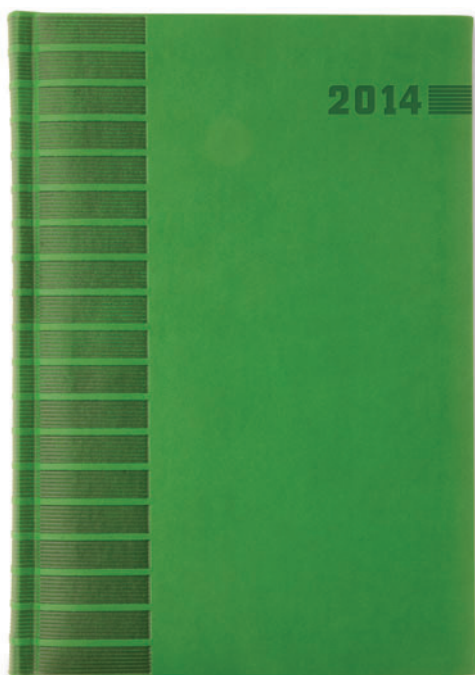

Denný diár A5

148 x 212 mm

ks	1-49	50+	200+	500+
€	4,857	4,531	4,286	4,041

hnedý

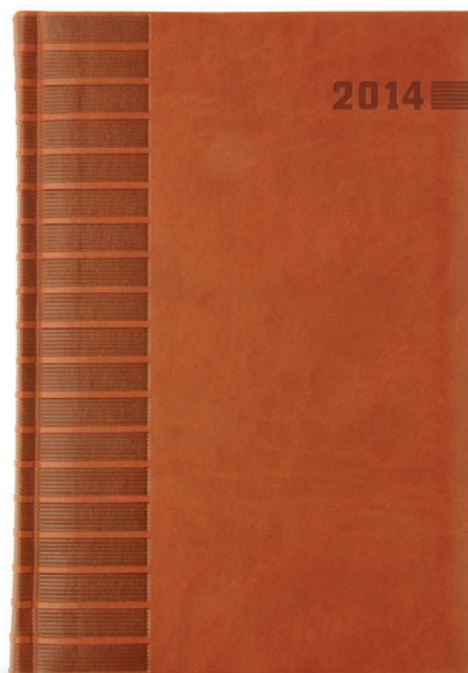

modrý

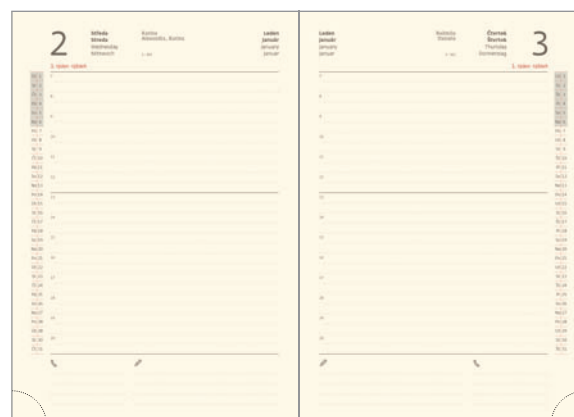
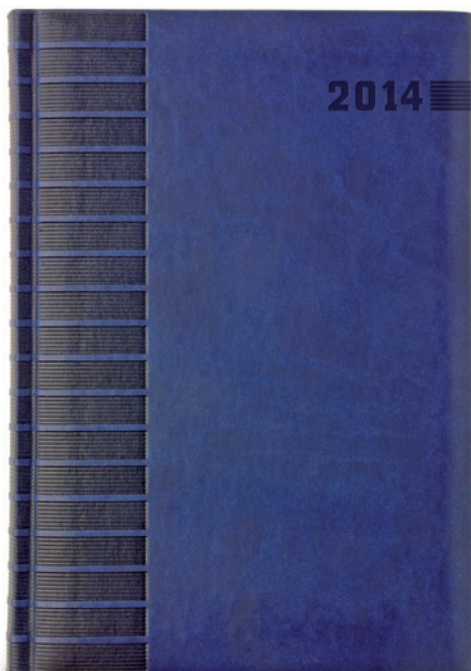

kalendárium denného diára A5

MANAGER 2014 kódy diárov podľa farieb

formát diára / farba	modrý	hnedý	červený	oranžový	zelený
denný A5	92501.M	92502.H	92505.R	92506.O	92507.Z
týždenný B5	92511.M	92512.H	92515.R	92516.O	92517.Z
vreckový	92521.M	92522.H	92525.R	92526.O	92527.Z

**TOP MANAGER 2014**

Príjemný a mäkký povrchový materiál imitujúci vzhľad kože zdobí razba letopočtu a kvalitné efektné prešitie po obvode. Materiál je najvhodnejší na označenie logom pomocou razby, možno použiť aj sieťotlač alebo tampoprint. Štvorjazyčné kalendárium (čeština, slovenčina, angličtina a nemčina), menné sviatky Českej a Slovenskej republiky, osobné údaje, plánovací kalendár pre ČR a SR, bohaté infostrany, perforované rožky. Kvalitný svetložitý papier, pre denný diár gramáže 70 g/m<sup>2</sup>, týždenný 90 g/m<sup>2</sup> a vreckový 60 g/m<sup>2</sup>. Denný a týždenný model obsahuje textilnú záložku. V zadnej časti denného diára je mapa A4 Českej a Slovenskej republiky a mapa A5 Európy, v zadnej časti týždenného diára je mapa B4 Českej a Slovenskej republiky a mapa B5 Európy.

TOP MANAGER 2014 kódy diárov podľa farieb			
formát diára / farba	modrý	svetlohnedý	tmavohnedý
denný A5	92531.M	92532.H	92533.H
týždenný B5	92541.M	92542.H	92543.H
vreckový	92551.M	92552.H	92553.H

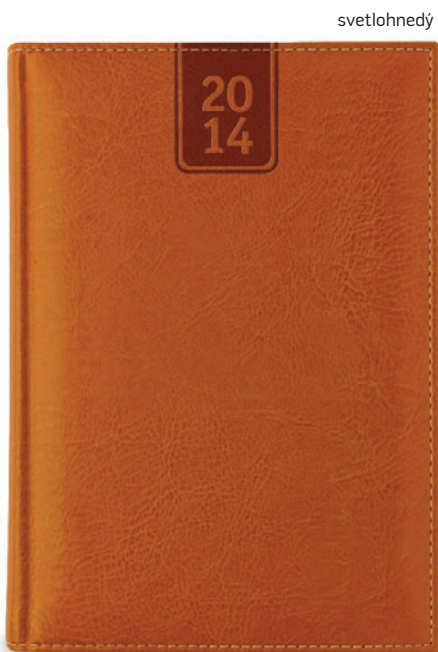

svetlohnedý



modrý



**Denný diár A5**

148 x 212 mm

ks	1-29	30+	120+	300+
€	6,082	5,673	5,347	5,020

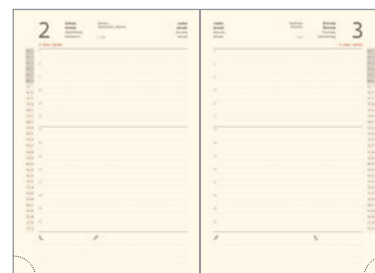

kalendárium denného diára A5

**Týždenný diár B5**

174 x 246 mm

ks	1-29	30+	120+	300+
€	6,490	6,041	5,673	5,347



kalendárium týždenného diára B5

tmavohnedý



**Vreckový diár**

84 x 155 mm

ks	1-59	60+	300+	800+
€	2,816	2,653	2,490	2,327



kalendárium vreckového diára



**PREMIER 2014**

Luxusný povrchový materiál z imitácie kože je vhodný na označenie razbou slepotlačou, možno použiť aj sieťotlač alebo tampoprint. Prijemný mäkký povrch je lesklý, zdobí ho razba letopočtu a efektná ozdobná razba v okolí chrbáta. Štvorjazyčné kalendárium (čeština, slovenčina, angličtina a nemčina), menné sviatky Českej a Slovenskej republiky, osobné údaje, plánovací kalendár pre ČR a SR, bohaté infostrany, perforované rožky. Kvalitný svetložitý papier, pri denných diároch gramáže 70 g/m<sup>2</sup>, týždenných 90 g/m<sup>2</sup> a vreckových 60 g/m<sup>2</sup>. Denný a týždenný model obsahuje textilnú záložku. V zadnej časti denného diára je mapa A4 Českej a Slovenskej republiky a mapa A5 Európy, v zadnej časti týždenného diára je mapa B4 Českej a Slovenskej republiky a mapa B5 Európy.

PREMIER 2014 kódy diárov podľa farieb		
formát diára / farba	modrý	hnedý
denný A5	92566.M	92561.H
týždenný B5	92567.M	92562.H
vreckový	92568.M	92563.H

**Týždenný diár B5**

174 x 246 mm

ks	1-29	30+	120+	300+
€	6,898	6,408	6,041	5,673

hnedý

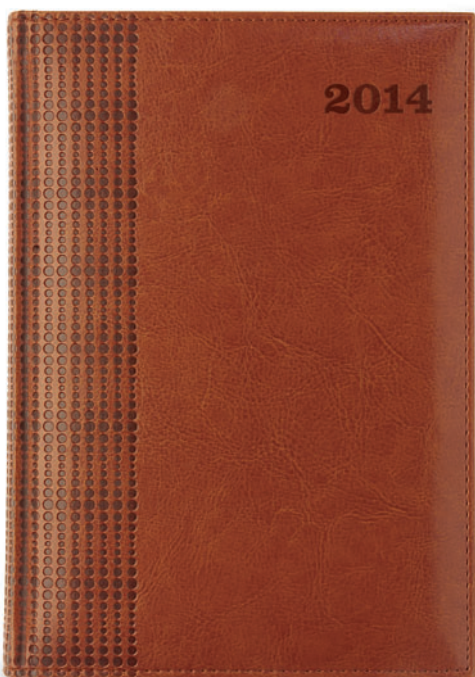

kalendárium týždenného diára B5



**Vreckový diár**

84 x 155 mm

ks	1-59	60+	300+	800+
€	3,020	2,816	2,653	2,490



kalendárium vreckového diára

modrý

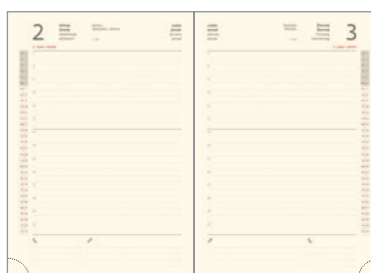
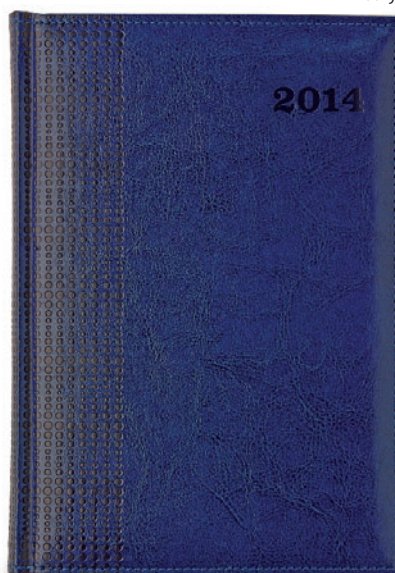

kalendárium denného diára A5

**Denný diár A5**

148 x 212 mm

ks	1-29	30+	120+	300+
€	6,490	6,041	5,673	5,347



45209.B

novinka



45215.B

novinka



Jednodielne novoročenky

200 x 100 mm  
sietotlač, razba, digitálna tlač

ks	1-499	500+	1500+	3.000+
€	0,404	0,376	0,351	0,331

45119.B



45120.B



45216.R

novinka



45122.B

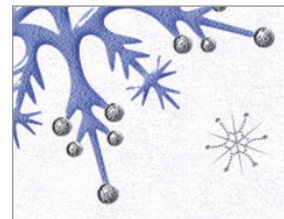
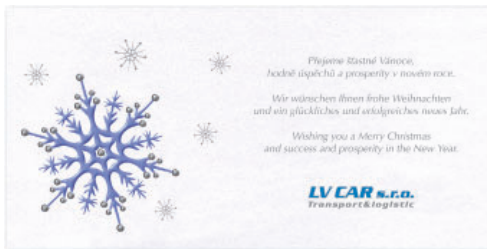

detail razby 45122.B

45217.B

novinka



45153.S

160 x 92 mm



Jednodielne novoročenky

200 x 100 mm  
sietotlač, razba, digitálna tlač

ks	1-399	400+	1500+	3000+
€	0,429	0,400	0,376	0,355

45104.Q



45176.R

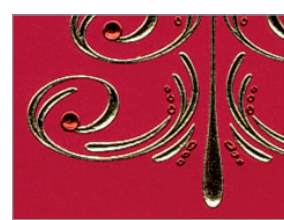

detail razby 45176.R





45131.M

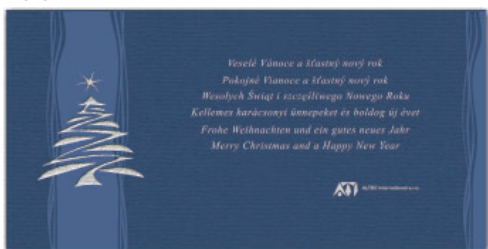

45145.Q



## Jednodielne novoročenky

200 x 100 mm  
sietotlač, razba, digitálna tlač

ks	1-399	400+	1200+	2500+
€	0,502	0,473	0,441	0,416

45218.Q

novinka

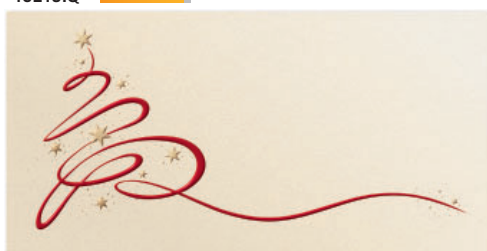

45219.M

novinka

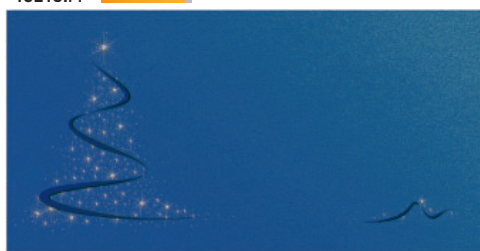

## Jednodielne novoročenky

200 x 100 mm  
sietotlač, razba, digitálna tlač

ks	1-399	400+	1200+	2500+
€	0,461	0,433	0,404	0,380

45154.M



45156.Q



detail razby 45156.Q

45158.M



45159.S



## Jednodielne novoročenky

100 x 200 mm  
sietotlač, razba, digitálna tlač

ks	1-399	400+	1200+	2500+
€	0,527	0,498	0,465	0,437



detail razby 45159.S

45152.R

## Jednodielna novoročenka

200 x 100 mm  
sietotlač, razba, digitálna tlač

ks	1-399	400+	1200+	2500+
€	0,527	0,498	0,465	0,437



## Cenník plnofarebnej dotlačie novoročieniek

počet kusov	1-99	100+	300+	1000+
cena v €/ks	0,320	0,280	0,240	0,200
technická príprava (bez ohľadu na počet farieb)	16 €/CMYK			

Digitálna dotlač novoročieniek špeciálnymi pigmentovými atramentami je plnohodnotnou alternatívou ku klasickým metódam razby a sietotlače. Cena za kus platí pre ľubovoľnú súťaž farieb, na novoročenku tak ide dotlačiť ľubovoľný text a logo s výnimkou striebornej, zlatej a bielej farby. Cenník ostatných technológií pre tlač novoročieniek nájdete na konci katalógu.



Ceny všetkých novoročieniek sú vrátane obálok.



novinka

45240.Z

Viacdielna novoročenka

135 x 135 mm  
sietotlač, razba, digitálna tlač

ks	1-199	200+	600+	1200+
€	1,029	0,959	0,902	0,849

novinka

45241.H

Viacdielna novoročenka

155 x 100 mm  
sietotlač, razba, digitálna tlač

ks	1-199	200+	600+	1200+
€	1,098	1,033	0,967	0,910



novinka

45242.Z

Viacdielna novoročenka

135 x 135 mm  
sietotlač, razba, digitálna tlač

ks	1-199	200+	600+	1200+
€	0,976	0,914	0,857	0,804



45150.M

Dvojdielna novoročenka

200 x 100 mm  
sietotlač, razba, digitálna tlač

ks	1-199	200+	600+	1200+
€	0,976	0,914	0,857	0,804



45190.M

Viacdielna novoročenka

100 x 200 mm  
sietotlač, razba, digitálna tlač

ks	1-199	200+	600+	1200+
€	1,029	0,959	0,902	0,849

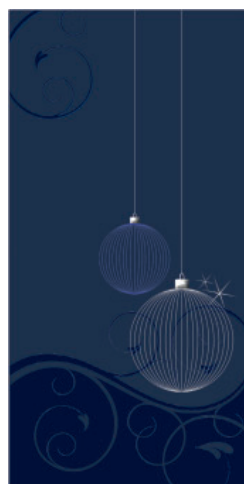

Digitálna dotlač novoročienok špeciálnymi pigmentovými atramentami je plnohodnotnou alternatívou ku klasickým metódam razby a sietotlače. Cena za kus platí pre ľubovoľnú súťaž farieb, na novoročenku tak ide dotlačiť ľubovoľný text a logo s výnimkou striebornej, zlatej a bielej farby. Cenník ostatných technológií pre tlač novoročienok nájdete na konci katalógu.

## Cenník plnofarebnej dotlače novoročienok

počet kusov	1-99	100+	300+	1000+
cena v €/ks	0,320	0,280	0,240	0,200
technická príprava (bez ohľadu na počet farieb)				16 €/CMYK

Ceny všetkých novoročienok sú vrátane obálok.



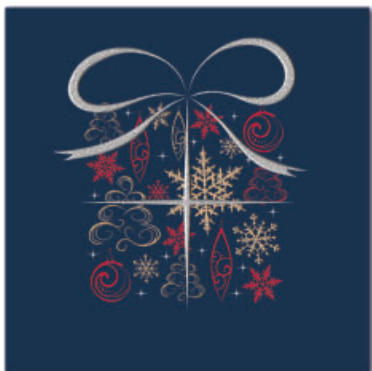

novinka

45243.M

Viacdielna novoročenka

135 x 135 mm  
sietotlač, razba, digitálna tlač

ks	1-199	200+	600+	1200+
€	1,139	1,094	1,053	1,016

novinka

45245.R

Viacdielna novoročenka

135 x 135 mm  
sietotlač, razba, digitálna tlač

ks	1-199	200+	600+	1200+
€	1,139	1,094	1,053	1,016



45199.M

Dvojdielna novoročenka

135 x 135 mm  
sietotlač, razba, digitálna tlač

ks	1-199	200+	600+	1200+
€	1,029	0,959	0,902	0,849



novinka

45244.B

Viacdielna novoročenka

100 x 155 mm  
sietotlač, razba, digitálna tlač

ks	1-199	200+	600+	1200+
€	1,180	1,139	1,102	1,061

41601.Q

Vianočné CD s aromatickými  
sviečkami155 x 155 x 30 mm  
tampoprint

ks	1-39	40+	200+	600+
€	4,857	4,490	4,163	3,882



Ceny všetkých novoročienok sú vrátane obálok.

Použitá logá a názvy sú registrovanými obchodnými značkami uvedených spoločností a sú na novoročenkách spolu s textami želaní znázornené iba pre ilustráciu potlače.

# Parker, Waterman, Lamy, Quill

JOTTER Stainless Steel GT

68722.S

guličkové pero

ks	1-14	15+	75+	150+
€	10,830	10,289	9,855	9,530



JOTTER Stainless Steel CT

68711.S

guličkové pero

ks	1-19	20+	100+	200+
€	9,170	8,712	8,345	8,070



68721.S

mechanická ceruzka 0,5 mm



JOTTER Stainless Steel CT

68731.S

sada guličkového pera  
a mechanickej ceruzky 0,5 mm

novinka

ks	1-9	10+	50+	100+
€	18,330	17,414	16,680	16,130



JOTTER PREMIUM Stainless Steel

guličkové pero

ks	1-14	15+	75+	150+
€	14,170	13,462	12,895	12,470



68701.S  
Classic



68702.C  
Satin Black



68703.S  
Shiny

Kompletný sortiment písacích potrieb PARKER JOTTER nájdete na našich webových stránkach.





## JOTTER

guličkové pero

ks	1-19	20+	100+	200+
€	6,920	6,574	6,297	6,090

68714.C Special Black



68712.B Special White



68713.R Special Red



68715.M Special Blue



PARKER

## VECTOR

guličkové pero

ks	1-19	20+	100+	200+
€	6,920	6,574	6,297	6,090

68515.R Standard Red



68511.C Standard Black



68512.B Standard White



68516.M Standard Blue

## VECTOR

roller

ks	1-19	20+	100+	200+
€	7,830	7,439	7,125	6,890

68536.M Standard Blue



68531.C Standard Black



68532.B Standard White



68535.R Standard Red

## VECTOR

Stainless Steel

guličkové pero

ks	1-14	15+	75+	150+
€	12,500	11,875	11,375	11,000

68518.S



roller

ks	1-9	10+	50+	100+
€	14,580	13,851	13,268	12,830

68538.S



Kompletný sortiment písacích potrieb PARKER JOTTER a VECTOR nájdete na našich webových stránkach.  
Doporučená potlač: tampoprint, laserový popis kovových častí, pri modeloch Vector tiež rotačná tlač po celom obvode.



URBAN

roller

ks	1-9	10+	50+	100+
€	22,920	21,774	20,857	20,170



68216.C  
Muted Black GT



68214.M  
Fashion Blue CT



68211.S  
Metro Metallic CT



68212.C Fashion Black CT



68213.S Fashion Silver CT



68215.R Fashion Magenta CT

URBAN

guličkové pero

ks	1-9	10+	50+	100+
€	17,500	16,625	15,925	15,400



68206.C  
Muted Black GT



68203.S  
Fashion Silver CT



68205.R  
Fashion Magenta CT



68201.S Metro Metallic CT



68202.C Fashion Black CT



68204.M Fashion Blue CT

Kompletný sortiment PARKER URBAN nájdete na našich webových stránkach.

Perá PARKER, WATERMAN, LAMY a QUILL sú balené jednotlivo v originálnych značkových krabičkách, ktoré sú v cene. Vzhľad krabičiek a balenia sa v priebehu roka môže meniť, čo ale nemá vplyv na cenu.

Na vyžiadanie vám dodáme darčekovú sadu zloženú z ľubovoľných dvoch modelov v spoločnej krabičke, cena bude jednoduchým súčtom cien vybraných modelov, spoločnú krabičku získate zdarma.

Doporučená potlač: tampoprint, laserový popis kovových častí.



## URBAN PREMIUM

roller

ks	1-4	5+	25+	50+
€	37,500	35,625	34,125	33,000

68222.C  
Matt Black68225.B  
Pearl Metal

68221.E Metallic Pink



68223.H Metallic Brown



68224.J Ebony Metal

## URBAN PREMIUM

guličkové pero

ks	1-4	5+	25+	50+
€	29,170	27,712	26,545	25,670

68235.B  
Pearl Metal68233.H  
Metallic Brown

68232.C Matt Black



68231.E Metallic Pink



68234.J Ebony Metal

## URBAN PREMIUM

plniace pero

ks	1-3	4+	20+	40+
€	48,330	45,914	43,980	42,530

68241.E  
Metallic Pink  
hrot F68244.J  
Ebony Metal  
hrot M

68242.C Matt Black, hrot M



68243.H Metallic Brown, hrot M



68245.B Pearl Metal, hrot F

Kompletný sortiment PARKER URBAN nájdete na našich webových stránkach. Šírka hrotov plniacich pier (F - tenký, M - stredný) je uvedená na našich webových stránkach či na dopyt.

PARKER IM



68305.M  
Blue CT



68309.G  
Brushed Metal GT

guličkové pero

ks	1-14	15+	75+	150+
€	14,170	13,462	12,895	12,470

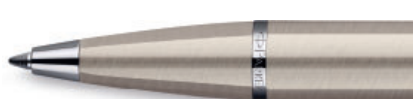

68302.S Brushed Metal CT



68303.C Black CT



68304.S Silver CT

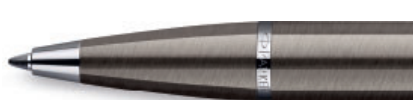

68307.J Gun Metal CT



68308.C Black GT



PARKER IM



68328.C  
Black GT



68324.S  
Silver CT

roller

ks	1-9	10+	50+	100+
€	17,500	16,625	15,925	15,400



68322.S Brushed Metal CT



68323.C Black CT



68325.M Blue CT



68327.J Gun Metal CT



68329.G Brushed Metal GT

Kompletný sortiment písacích potrieb PARKER IM nájdete na našich webových stránkach. Doporučená potlač: tampoprint, laserový popis kovových častí.



## PARKER IM PREMIUM

pero piatej dimenzie

novinka

**PARKER 5<sup>TH</sup>**  
 PÁTÁ DIMENZE PSACÍCH POTŘEB

ks	1-3	4+	20+	40+
€	39,170	37,212	35,645	34,470

**68350.J**  
 Deep Gun Metal

**68351.Q**  
 Twin Chiselled

**68352.S**  
 Shiny Chrome

PARKER

## PARKER IM PREMIUM

roller

ks	1-9	10+	50+	100+
€	28,330	26,914	25,780	24,930

**68330.C**  
 Matt Black

**68343.J** Deep Gun Metal

**68346.Q** Twin Chiselled

**68349.S** Shiny Chrome

## PARKER IM PREMIUM

plniace pero

ks	1-4	5+	25+	50+
€	37,500	35,625	34,125	33,000

**68344.Q**  
 Twin Chiselled  
 hrot F

**68341.J** Deep Gun Metal, hrot F

**68339.C** Matt Black, hrot M

**68347.S** Shiny Chrome, hrot F

## PARKER IM PREMIUM

guličkové pero

ks	1-9	10+	50+	100+
€	21,250	20,188	19,338	18,700

**68340.C**  
 Matt Black

**68342.J** Deep Gun Metal

**68345.Q** Twin Chiselled

**68348.S** Shiny Chrome

Kompletný sortiment PARKER IM nájdete na našich webových stránkach. Šírka hrotov plniacich pier (F - tenký, M - stredný) je uvedená na našich webových stránkach či na dopyt.

Rada PARKER 5TH™ predstavuje novú generáciu písacích potrieb, ktorá využíva revolučný, doslova piaty typ náplne – PARKER 5TH™, ktorý zaručuje výnimočne plynulé písanie ľahkou rukou pri zachovaní intenzívnej a ostrej stopy. Už počas prvých ťahov sa prispôbí individuálnemu štýlu písania majiteľa.

Modelová rada PARKER INGENUITY prekračuje očakávania z hľadiska nárokov na súčasný dizajn, prináša mimoriadne príjemný pocit z písania ľahkou rukou i komfort spojený s používaním náplne, ktorá nešpiní. Flexibilný hrot náplne sa opiera o kovový ochranný hrot pera pokovaný zlatom alebo chrómom. Všetky perá rady PARKER INGENUITY majú nasadzovacie viečko a dodávajú sa s čiernou náplňou s tenkým alebo stredným hrotom.

**PARKER 5TH™**  
PIATA DIMENZIA PÍSACÍCH POTRIEB



**PARKER URBAN** Premium

pero piatej dimenzie

novinka

ks	1-2	3+	15+	30+
€	55,000	52,250	50,050	48,400



68251.B  
Pearl Metal



68252.J  
Ebony Metal

**PARKER INGENUITY**

pero piatej dimenzie

ks	1	2+	10+	20+
€	112,500	106,875	102,375	99,000



68622.C  
Black Lacquer CT



68621.C  
Black Lacquer GT

**PARKER INGENUITY**

pero piatej dimenzie

ks	1	2+	10+	20+
€	112,500	106,875	102,375	99,000



68615.C  
Black Lacquer CT



68616.C  
Black Lacquer GT

Kompletný sortiment písacích potrieb PARKER INGENUITY a URBAN nájdete na našich webových stránkach.

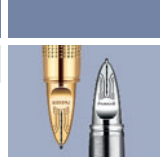

## PARKER INGENUITY

pero piatej dimenzie

novinka

ks	1	2+	10+	20+
€	129,170	122,712	117,545	113,670



**68623.B**  
Pearl Metal & Lacquer GT



**68624.C**  
Black Metal & Rubber GT



**PARKER 5<sup>TH</sup>**  
PIATA DIMENZIA PÍSACÍCH POTRIEB



## PARKER INGENUITY

pero piatej dimenzie

ks	1	2+	10+	20+
€	129,170	122,712	117,545	113,670



**68617.C**  
Black Metal & Rubber CT



**68618.H**  
Brown Metal & Rubber CT



**68619.C**  
Black Rubber CT



**68620.S**  
Chrome CT

Kompletný sortiment PARKER INGENUITY nájdete na našich webových stránkach.

Perá PARKER, WATERMAN, LAMY a QUILL sú balené jednotlivo v originálnych značkových krabičkách, ktoré sú v cene. Vzhľad krabičiek a balenia sa v priebehu roka môže meniť, čo ale nemá vplyv na cenu.

Na vyžiadanie vám dodáme darčekovú sadu zloženú z ľubovoľných dvoch modelov v spoločnej krabičke, cena bude jednoduchým súčtom cien vybraných modelov, spoločnú krabičku získate zdarma.

Doporučená potlač: tampoprint, laserový popis kovových častí.



QUILL 510

novinka

guličkové pero s modrou náplňou

ks	50-99	100+	200+	400+
€	19,580	18,601	17,818	17,230

Cena vrátane plnofarebného logotypu 10 x 13 mm na oválnu korunku (účtovaná len technická príprava 15 €), minimálny odber 50 ks. Termín dodania cca 4 týždne od schválenia výrobných korektúr.



68860.S  
Chrome



68861.C  
Matt Black



68862.M  
Matt Blue



68863.B  
White Pearl

LAMY LOGO

Brushed Steel

68902.S

sada guličkového pera s čiernou náplňou a mechanickej ceruzky 0,5 mm s koženým puzdrom

ks	1-4	5+	25+	50+
€	29,580	28,101	26,918	26,030

brúsená nerezová oceľ



Ukážka balenia sady LAMY LOGO

**LAMY**

LAMY SPIRIT

Steel

68903.S

unikátna sada guličkového pera s čiernou náplňou a mechanickej ceruzky 0,5 mm s vymeniteľnou gumou

ks	1-3	4+	20+	40+
€	47,080	44,726	42,843	41,430

telo a klip tvoria jeden celok, leštená nerezová oceľ

Ukážka balenia pier LAMY SPIRIT



Kompletný sortiment písacích potrieb QUILL a LAMY nájdete na našich webových stránkach. Doporučená potlač: tampoprint, laserový popis kovových častí.



**EXPERT** DeLuxe Black CT
**68030.C**  
 guličkové pero

ks	1	2+	10+	20+
€	80,000	76,000	72,800	70,400

**68031.C**  
 roller

ks	1	2+	10+	20+
€	88,330	83,914	80,380	77,730

**68032.C**  
 plniace pero  
 hrot F

ks	1	2+	10+	20+
€	104,170	98,962	94,795	91,670

**EXPERT** DeLuxe Precious CT
**WATERMAN**  
 PARIS

**68033.J**  
 guličkové pero

ks	1	2+	10+	20+
€	100,000	95,000	91,000	88,000

**68034.J**  
 roller

ks	1	2+	10+	20+
€	108,330	102,914	98,580	95,330

**68035.J**  
 plniace pero  
 hrot F

ks	1	2+	10+	20+
€	129,170	122,712	117,545	113,670

**EXPERT** Essential Metallic GT
**68036.S**  
 guličkové pero

ks	1-2	3+	15+	30+
€	62,500	59,375	56,875	55,000

**68037.S**  
 roller

ks	1	2+	10+	20+
€	70,830	67,289	64,455	62,330

**68038.S**  
 plniace pero  
 hrot F

ks	1	2+	10+	20+
€	81,670	77,587	74,320	71,870



Kompletný sortiment WATERMAN EXPERT nájdete na našich webových stránkach. Šírka hrotov plniacich pier (F - tenký, M - stredný) je uvedená na našich webových stránkach či na dopyt.

# Písacie potreby

## Guličkové pero MICRO s mikrohrotom

Ø 10 x 138 mm  
tampprint

ks	1-999	1000+	5000+	12000+
€	0,257	0,239	0,222	0,213



Guličkové pero s veľmi tenkým hrotom 0,5 mm pre jemné písanie.



41832.R



41830.B



41831.M



41833.Y



41834.C



41838.O



41836.R



41835.M



41837.Z

**Guličkové pero  
s metalízou ROKI**

 Ø 10 x 134 mm  
tampoprint

ks	1-999	1000+	5000+	10 000+
€	0,196	0,187	0,178	0,170



41854.J



41850.M



41851.Z



41852.O



41853.S

**Guličkové pero LADA**

 Ø 10 x 134 mm  
tampoprint

ks	1-1499	1500+	7500+	15 000+
€	0,143	0,135	0,126	0,117



41840.M



41841.Y



41842.Z



41843.R

**Guličkové pero DARA**

 Ø 11 x 140 mm  
tampoprint

ks	1-1499	1500+	7500+	15 000+
€	0,143	0,135	0,126	0,117



41810.B



41811.M



41812.R



novinka

Guličkové pero  
s metalízou VERA

Ø 10 x 142 mm  
tampoprint

ks	1-999	1000+	5000+	10000+
€	0,200	0,187	0,174	0,165



41991.R



41990.M



41992.O



41993.F



41994.Z



41820.S



41822.R

Guličkové pero DARA silver

Ø 11 x 140 mm  
tampoprint

ks	1-1499	1500+	7500+	15000+
€	0,170	0,161	0,152	0,148



41821.M



41823.Z



41825.Y

Guličkové pero

Ø 10 x 142 mm  
tampoprint

ks	1-1499	1500+	7500+	15000+
€	0,135	0,126	0,117	0,113

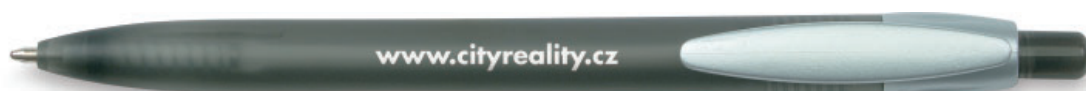

43001.TK

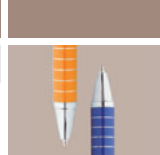

43003.K

**Guličkové pero MONI**

Ø 12 x 140 mm  
tampoprint

ks	1-999	1 000+	5 000+	10 000+
€	0,187	0,174	0,161	0,152



41961.R



41960.M



41962.Z



41963.C



41964.O

**Guličkové pero MONI silver**

Ø 12 x 140 mm  
tampoprint

ks	1-999	1 000+	5 000+	10 000+
€	0,196	0,183	0,170	0,161



41965.M



41966.R



41967.Z



41968.C



41969.O



**Guličkové pero FANY**

Ø 15 x 137 mm  
tampoprint

ks	1-999	1000+	5000+	10000+
€	0,196	0,187	0,183	0,178



20812.O



20814.M



20813.Z



20811.R

**Guličkové pero  
s kovovým klipom**

Ø 10 x 131 mm  
tampoprint

ks	1-999	1000+	5000+	15000+
€	0,196	0,183	0,170	0,161



42035.O



42031.M



42032.R



42033.Z



42034.S

**Guličkové pero**

Ø 10 x 135 mm  
tampoprint

ks	1-999	1000+	5000+	10000+
€	0,196	0,183	0,170	0,161



42241.B



42242.C



novinka

## Guličkové pero s metalizovanými doplnkami ALEX

Ø 12 x 138 mm  
tampoprint

ks	1-799	800+	4 000+	8 000+
€	0,274	0,257	0,239	0,226



42076.Z



42074.M



42075.R



42077.S



42078.C



42079.E

## Guličkové pero GREG

Ø 11 x 137 mm  
tampoprint

ks	1-1 499	1 500+	7 500+	15 000+
€	0,170	0,157	0,143	0,135



41860.M



41862.Z



41864.C

## Guličkové pero

Ø 10 x 135 mm  
tampoprint

ks	1-999	1 000+	5 000+	10 000+
€	0,196	0,183	0,170	0,161



42243.M



42244.V

**Guličkové pero ALBANY**

Ø 12 x 133 mm  
tampoprint

ks	1-999	1000+	5000+	10000+
€	0,191	0,178	0,165	0,157



42058.M



42059.C

**Transparentné guličkové pero ALBANY**

Ø 12 x 132 mm  
tampoprint

ks	1-999	1000+	5000+	10 000+
€	0,191	0,178	0,165	0,157



42055.TO



42050.TM



42051.TR



42053.TZ



42054.TB

**Guličkové pero ŠIPKA**

Ø 14 x 141 mm  
tampoprint

ks	1-999	1000+	5000+	10000+
€	0,170	0,161	0,152	0,143



42070.C

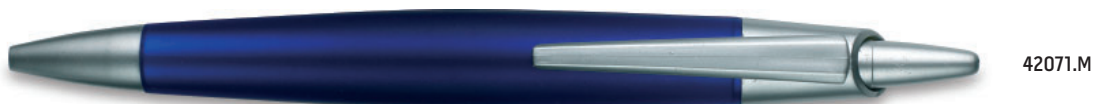

42071.M



42072.R



42073.Z



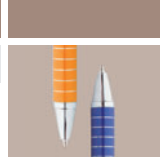

## Guličkové pero OKAY

Ø 10 x 139 mm  
tampprint

ks	1-999	1000+	5000+	15000+
€	0,230	0,213	0,196	0,183



41930.TM



41931.TO



41932.TR



41933.TZ



41934.TY



41935.M



41936.O



41937.R



41938.Z



**Guličkové pero METALLIC s kovovými doplnkami**

Ø 11 x 136 mm  
tampoprint, laserový popis

ks	1-499	500+	2000+	4000+
€	0,370	0,343	0,317	0,300



49302.M



49304.R

**Guličkové pero SÁRA**

Ø 10 x 133 mm  
tampoprint

ks	1-799	800+	4000+	8000+
€	0,243	0,235	0,226	0,222



80401.R



80402.M



80403.Z



80404.C



80405.S

**Guličkové pero TIKO silver s kovovými doplnkami**

Ø 11 x 145 mm  
tampoprint

ks	1-699	700+	3500+	7000+
€	0,291	0,283	0,274	0,265



29019.0



29016.C



29017.M



29018.Z

**Guličkové pero s vlnitým kovovým klipom**

Ø 9 x 141 mm  
tampoprint

ks	1-999	1000+	5000+	10000+
€	0,187	0,174	0,161	0,152



43053.TM



43052.TK



**Plastové  
guličkové pero EMA**

Ø 9 x 139 mm  
tampoprint

ks	1-999	1 000+	5 000+	10 000+
€	0,257	0,239	0,222	0,204



41973.Y



41970.B



41971.M



41972.R



41974.O



41975.V

**Hliníkové guličkové pero  
EMA ALU**

Ø 9 x 139 mm  
tampoprint, laserový popis

ks	1-399	400+	2 000+	4 000+
€	0,496	0,461	0,426	0,400



41986.Z



41980.B



41981.M

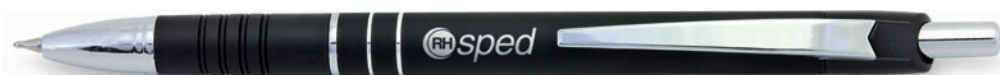

41982.R

41983.C  
lesk41984.C  
mat

41985.S

novinka



Plastové otočné guľičkové pero so stylusom

Ø 11 x 135 mm  
tampoprint

ks	1-399	400+	2000+	4000+
€	0,474	0,457	0,439	0,430

29002.C



29003.M



29004.S



Plastové guľičkové pero s kovovými doplnkami

Ø 12 x 143 mm  
tampoprint

ks	1-399	400+	2000+	4000+
€	0,439	0,426	0,409	0,400



29085.C



29087.B



29086.M



29088.S

Mechanická ceruzka 0,5mm TRIANGL s gumou

Ø 10 x 149 mm  
tampoprint

ks	1-299	300+	1500+	3000+
€	0,735	0,691	0,665	0,639



42018.M



42019.C

Guľičkové pero TRIANGL

Ø 10 x 148 mm  
tampoprint

ks	1-299	300+	1500+	3000+
€	0,670	0,622	0,574	0,539



42015.M



42016.C



**Guličkové pero s gélovou náplňou GELOVKA**

Ø 10 x 143 mm  
tampoprint

ks	1-299	300+	1500+	3000+
€	0,617	0,570	0,530	0,496

Unikátne pero s anatomicky dokonalým úchopom a modrou gélovou náplňou 0,5 mm pre jemné a neuveriteľne pohodlné písanie.



41816.C



41815.M

43332.M

**Kovová mechanická ceruzka s gumou ATUL**

Ø 10 x 142 mm  
tampoprint, laserový popis

ks	1-299	300+	1500+	3000+
€	0,813	0,761	0,717	0,674



43331.M

**Kovové guličkové pero ATUL**

Ø 10 x 142 mm  
tampoprint, laserový popis

ks	1-299	300+	1500+	3000+
€	0,735	0,691	0,657	0,630

**Kovové guličkové pero LENA**

Ø 10 x 143 mm  
tampoprint, laserový popis

ks	1-299	300+	1500+	3000+
€	0,735	0,691	0,657	0,630



43311.G



43312.C



43313.M

**Kovové guličkové pero BIRD s gumovým úchopom**

Ø 11 x 142 mm  
tampoprint, laserový popis

ks	1-299	300+	1500+	3000+
€	0,735	0,691	0,657	0,630



43322.S



43321.C

**Kovové guľičkové pero MAESTRO**

Ø 9 x 130 mm  
tampoprint, laserový popis

ks	1-199	200+	1000+	2000+
€	1,009	0,930	0,865	0,804



41917.J



41916.S



41918.R

**Kovový roller MAESTRO**

Ø 10 x 138 mm  
tampoprint, laserový popis

ks	1-119	120+	600+	1200+
€	1,678	1,548	1,439	1,343



41927.J



41926.S



41928.R

**Kovové guľičkové pero**

Ø 8 x 128 mm  
tampoprint, laserový popis

ks	1-499	500+	2500+	5000+
€	0,430	0,413	0,400	0,387

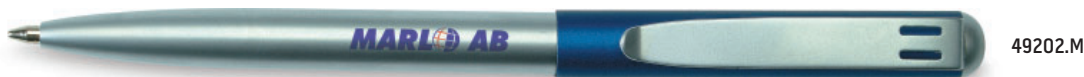

49202.M



49203.C

**Kovové guľičkové pero SLIM**

Ø 8 x 136 mm  
tampoprint, laserový popis

ks	1-199	200+	1000+	2000+
€	0,861	0,839	0,817	0,796



49312.M

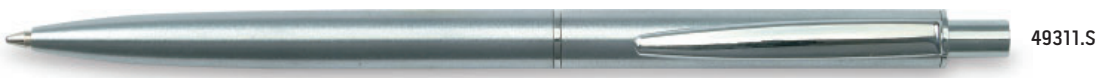

49311.S



49313.C



49314.V



Kovové guľičkové pero LUX  
so strieborným zdobením

novinka

Ø 10 x 139 mm  
tampoprint, laserový popis

ks	1-249	250+	1250+	2500+
€	0,765	0,709	0,657	0,613



42045.C



42046.J



42047.V



42048.M



42049.Z

Kovové guľičkové  
pero KORNA

Ø 10 x 138 mm  
tampoprint, laserový popis

ks	1-299	300+	1500+	3000+
€	0,604	0,561	0,517	0,474



43371.C



43373.R

Kovové twist  
guľičkové pero

Ø 8 x 128 mm  
tampoprint, laserový popis

ks	1-499	500+	2500+	5000+
€	0,430	0,404	0,387	0,378



42004.M



42005.C

**Guličkové pero ROTRING TIKKY  
v darčekovej krabičke**

novinka

**rotring**

Ø 9 x 139 mm (pero) / 182 x 20 x 20 mm (box)  
tampoprint

ks	1-49	50+	250+	500+
€	4,143	3,991	3,848	3,761



35040.C



35041.M



35042.B



**Kovové guličkové pero CORONA**

Ø 11 x 136 mm  
tampoprint, laserový popis

ks	1-199	200+	1000+	2000+
€	1,057	0,974	0,904	0,843



41893.C



41894.Z



41896.M

**Kovové guličkové pero VANESSA**

Ø 10 x 138 mm  
tampoprint, laserový popis

ks	1-299	300+	1500+	3000+
€	0,735	0,678	0,626	0,587



41882.C



41883.R



41884.Z





## Kovové guličkové pero SUN

Ø 10 x 134 mm  
tampoprint, laserový popis

ks	1-399	400+	2000+	5000+
€	0,648	0,600	0,557	0,517



41886.G



41885.S



41887.M



41888.R



41889.C

Kovové guličkové pero  
s trojuholníkovým úchopom

Ø 11 x 129 mm  
tampoprint, laserový popis

ks	1-499	500+	2500+	5000+
€	0,430	0,413	0,400	0,387



49241.S



49243.R

## Kovové guličkové pero AMBI

Ø 10 x 133 mm  
tampoprint, laserový popis

ks	1-399	400+	2000+	5000+
€	0,604	0,561	0,517	0,474



41871.S



41874.R



41875.M



41872.K



BALMAIN  
PARIS

Kovové na čierno písuce guľičkové  
pero ARLES v zamatovom obale

Ø 9 x 139 mm  
tampoprint, laserový popis

ks	1-69	70+	350+	700+
€	3,087	2,974	2,865	2,800



35030.C



35031.M



35032.S

Kovové  
guľičkové pero

Ø 8 x 139 mm  
tampoprint, laserový popis

ks	1-99	100+	500+	1000+
€	1,239	1,152	1,065	1,013



42211.Q  
TENIS



42210.Q  
FOTBAL

Kovové guľičkové pero  
HOOK s pružinou

Ø 12 x 134 mm  
tampoprint, laserový popis

ks	1-199	200+	1000+	2000+
€	0,857	0,804	0,778	0,752

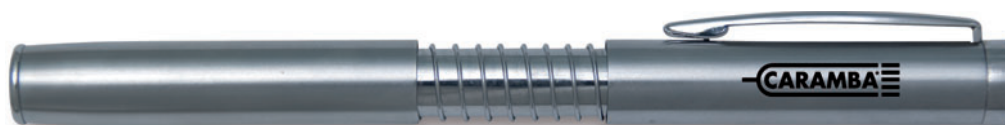

49341.S



49343.R



49344.C



novinka



Hliníkové guľčkové pero so stylusom

Ø 9 x 125 mm  
tampoprint, laserový popis

ks	1-149	150+	750+	1500+
€	1,200	1,152	1,104	1,078



80431.B



80432.Y



80433.O



80434.R



80435.M



80436.Z



80437.C



80438.E

29005.S



Kovové guľčkové pero so stylusom v zamatovom obale

novinka

Ø 8 x 105 mm (pero) / 31 x 132 x 1 mm (obal)  
tampoprint, laserový popis (pero), transfer (obal)

ks	1-79	80+	400+	800+
€	2,413	2,326	2,243	2,191



Kovové guľčkové pero

Ø 13 x 139 mm  
tampoprint, laserový popis

ks	1-199	200+	1000+	2000+
€	0,857	0,804	0,778	0,752



49322.M



49324.R



41955.S



41956.C

Kovové keramické pero ROLLER STYLE

Ø 11 x 137 mm  
tampoprint, laserový popis

ks	1-99	100+	500+	1000+
€	1,457	1,343	1,248	1,165



41957.M



41999.C

Kovové guľičkové pero a mechanická ceruzka v jednom

Ø 10 x 139 mm  
tampoprint, laserový popis

ks	1-119	120+	600+	1200+
€	1,735	1,600	1,487	1,387

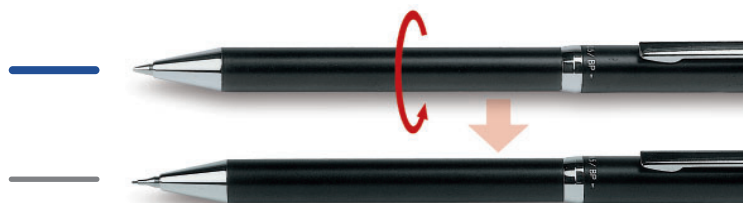

41997.S

Multifunkčné pero 6 v 1

Ø 14 x 142 mm  
tampoprint

ks	1-299	300+	1500+	3000+
€	0,639	0,591	0,548	0,513



štvorfarebné guľičkové pero, mechanická ceruzka, guma



41998.TM

Štvorfarebné guľičkové pero

Ø 12 x 139 mm  
tampoprint

ks	1-499	500+	2500+	5000+
€	0,274	0,257	0,243	0,230



modrá, červená, zelená a čierna náplň



**41922.C**

**Kovový roller SAVA**

Ø 12 x 141 mm  
tampoprint, laserový popis

ks	1-59	60+	300+	600+
€	3,448	3,183	2,952	2,757



**41911.M**

**Kovové guľičkové pero RITA**

Ø 12 x 139 mm  
tampoprint, laserový popis

ks	1-99	100+	500+	1000+
€	2,604	2,461	2,339	2,239



**41912.M**

**Kovový roller RITA**

Ø 12 x 137 mm  
tampoprint, laserový popis

ks	1-99	100+	500+	1000+
€	2,926	2,778	2,587	2,465



**Kovové multifunkčné pero 4 v 1**

Ø 10 x 144 mm  
tampoprint, laserový popis

ks	1-99	100+	500+	1000+
€	2,326	2,170	2,013	1,878

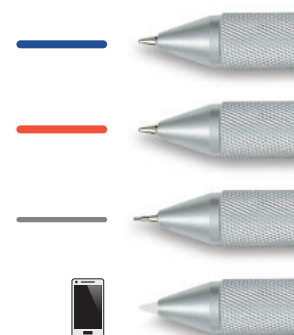

modrá a farebná náplň,  
mechanická ceruzka a stylus

**Kovové multifunkčné pero CRISTAL 4 v 1**

Ø 10 x 145 mm  
tampoprint, laserový popis

ks	1-99	100+	500+	1000+
€	1,565	1,448	1,343	1,252



**43302.S**



**43303.M**



modrá a červená náplň,  
mechanická ceruzka a stylus

16270.C

Kovové guľičkové pero METAL  
s dierovaným klipom  
v darčekovom boxe

160 x 30 x 30 mm (box)  
tampoprint, laserový popis

ks	1-79	80+	400+	800+
€	2,518	2,363	2,278	2,224



nová  
farba

29010.S

Hliníkové guľičkové pero  
vo farebnom darčekovom boxe

177 x 37 x 18 mm (box)  
tampoprint, laserový popis

ks	1-99	100+	500+	1000+
€	2,057	1,970	1,896	1,843



80411.R



80412.M



80410.B



80413.C

43921.S

Kovové guľičkové pero  
KINGSTYLE v darčekovej krabičke

170 x 45 x 25 mm (box)  
tampoprint, laserový popis

ks	1-99	100+	500+	1000+
€	2,126	1,996	1,891	1,796

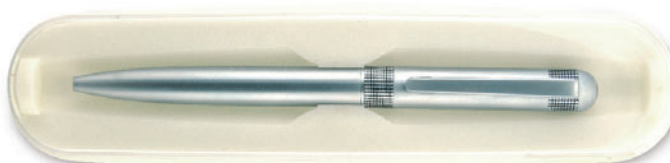



**Kovové guličkové pero GRETA  
v darčekovej krabičke**

novinka

Ø 11 x 137 mm (pero) / 164 x 45 x 26 (box)  
tampoprint, laserový popis

ks	1-99	100+	500+	1000+
€	1,891	1,761	1,630	1,543

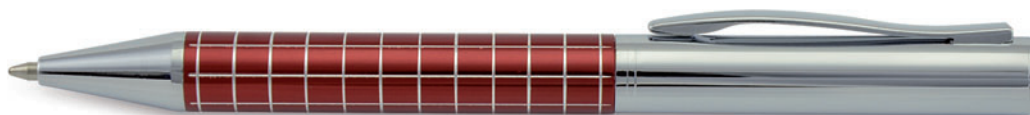

42088.R



42085.C



42086.Z



42087.M

**Kovové guličkové pero  
KINGSTYLE v darčekovej krabičke**

nové  
balenie

Ø 13 x 138 mm (pero) / 164 x 45 x 26 mm (box)  
tampoprint, laserový popis

ks	1-99	100+	500+	1000+
€	1,674	1,596	1,535	1,465



49221.S



49222.C

**Kovové guličkové pero TENA  
v darčekovej krabičke**

nové  
balenie

Ø 11 x 136 mm (pero) / 164 x 45 x 26 (box)  
tampoprint, laserový popis

ks	1-119	120+	600+	1200+
€	1,735	1,600	1,487	1,387



41907.S



41906.C



41959.M

Sada kovového guľičkového pera a mechanickej ceruzky TINA

170 x 45 x 20 mm (box)  
tampoprint, laserový popis

ks	1-99	100+	500+	1000+
€	1,904	1,757	1,630	1,522



43333.M

Sada kovového guľičkového pera a mechanickej ceruzky s gumou ATUL

170 x 45 x 20 mm (box)  
tampoprint, laserový popis

ks	1-99	100+	500+	1000+
€	1,970	1,848	1,752	1,665



42011.C



42010.M



Sada guľičkového pera a mechanickej ceruzky s gumou TRIANGL

170 x 45 x 20 mm (box)  
tampoprint

ks	1-99	100+	500+	1000+
€	1,735	1,648	1,578	1,526







# rotring

novinka

Kovové guľkové pero ROTRING  
MADRID v darčekovej krabičke

Ø 9 x 134 mm  
tampoprint, laserový popis

ks	1-29	30+	150+	300+
€	8,565	8,217	7,957	7,739



35046.C



35045.S



35047.S



novinka

Kovová mechanická ceruzka ROTRING  
MADRID v darčekovej krabičke

Ø 9 x 137 mm  
tampoprint, laserový popis

ks	1-29	30+	150+	300+
€	8,565	8,217	7,957	7,739

35048.C



43902.T

Darčeková krabička  
na 1 pero s reklamnou  
plochou vo vnútri

novinka

164 x 45 x 26 mm  
tampoprint

ks	1-399	400+	2000+	4000+
€	0,474	0,448	0,422	0,404



90692.M

90691.B

90693.C

Papierové puzdro na 1 až 2 perá

165 x 58 mm  
tampoprint, sietotlač

ks	1-999	1000+	5000+	15000+
€	0,187	0,174	0,165	0,152

Sada kovového guličkového pera a rollera vo farebnom puzdre

168 x 65 x 20 mm (puzdro)  
 Ø 10 x 133 mm (perá)  
 tampoprint, laserový popis, sietotlač

ks	1-39	40+	200+	400+
€	6,043	5,826	5,609	5,478

guličkové pero s modrou náplňou,  
 roller s čiernou náplňou



29092.R



29091.M



29090.C



29095.C



Sada hliníkového guličkového pera a mechanickej ceruzky v PU puzdre

150 x 43 x 22 mm (puzdro)  
 tampoprint, laserový popis

ks	1-69	70+	350+	700+
€	3,135	3,017	2,909	2,843



29096.S

29022.M

29024.O



29023.R

Sada guličkového pera a mechanickej ceruzky v kovovom boxe

165 x 55 x 15 mm (box)  
 tampoprint, laserový popis

ks	1-89	90+	450+	900+
€	2,204	2,122	2,043	1,996





## andré philippe

80430.C

Hliníková sada guľičkového pera a rollera André Philippe

novinka

180 x 63 x 30 mm (box)  
tampoprint, laserový popis

ks	1-29	30+	150+	200+
€	6,739	6,478	6,217	6,043

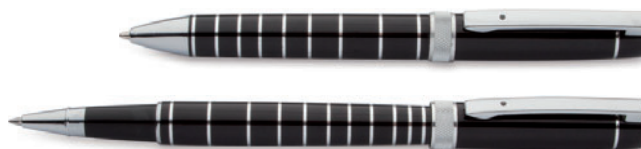

41977.J

Písací set kovového guľičkového pera a rollera MAESTRO

169 x 51 x 21 mm (box)  
tampoprint, laserový popis

ks	1-49	50+	250+	500+
€	3,804	3,513	3,261	3,043



41976.S



41978.R



42230.M

Darčeková sada kovového guľičkového pera a rollera

197 x 66 x 20 mm (box)  
tampoprint, laserový popis

ks	1-29	30+	150+	300+
€	6,652	6,130	5,696	5,348





**16271.C**

Masívna sada kovového guľičkového pera a rollera CARBON

179 x 64 x 40 mm (box)  
tampoprint, laserový popis

ks	1-9	10+	50+	100+
€	15,755	14,776	14,245	13,918

Povrchová úprava z pravého karbónu, na čierno písúci roller, na modro písúce twist guľičkové pero.



**68803.C**

Značková sada guľičkového pera a mechanickej ceruzky TIKKY

175 x 78 x 18 mm (box)  
tampoprint

ks	1-29	30+	150+	300+
€	6,652	6,348	6,043	5,739

**rotring**

**68802.M**



**68801.B**

**41913.M**

Darčekový set guľičkového pera a rollera RITA

171 x 71 x 31 mm (box)  
tampoprint, sietotlač, laserový popis

ks	1-39	40+	200+	400+
€	7,261	6,739	6,348	5,957



**16001.S****Luxusná kovová súprava guličkového pera a rollera STERLING**

179 x 64 x 40 mm (box)  
tampoprint, laserový popis

ks	1-19	20+	100+	200+
€	10,816	10,163	9,796	9,551

hladká plocha pre logo  
na vrchnáku rollera aj pera

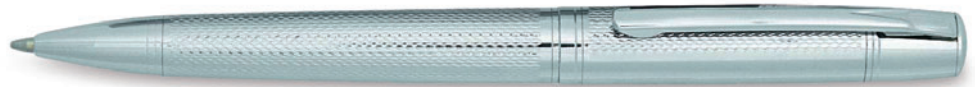

na modro písuce guličkové  
pero, na čierno písúci roller

**16009.S****Set kovového guličkového pera a rollera BROADWAY**

164 x 60 x 27 mm (box)  
tampoprint, laserový popis

ks	1-29	30+	150+	300+
€	7,796	7,347	7,061	6,898

**42231.S****Kovové guličkové pero v magnetickom stojane**

Ø 56 x 25 mm (stojan)  
Ø 15 x 115 mm (pero)  
100 x 134 mm (box)  
tampoprint, laserový popis

ks	1-49	50+	250+	500+
€	4,239	4,013	3,726	3,587





**16011.C**

Kovové guľičkové pero PEARL  
vykladané perleťou v darčekovom boxe

178 x 48 x 35 mm (box)  
tampoprint, laserový popis

ks	1-14	15+	75+	150+
€	14,122	13,224	12,776	12,490

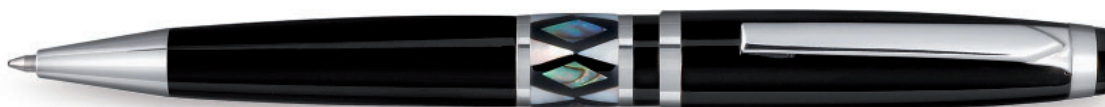

**51247.C**

Darčekový na čierno písúci set plniaceho  
a guľičkového pera GRAND

186 x 72 x 47 mm (box)  
tampoprint, laserový popis

ks	1-14	15+	75+	150+
€	15,043	14,522	14,000	13,652

**41923.C**

Darčekový set  
guľičkového pera  
a rollera SAVA

157 x 65 x 28 mm (box)  
tampoprint, laserový popis

ks	1-29	30+	150+	300+
€	8,565	8,043	7,696	7,435





**Guličkové pero DIAMOND  
s krištálkami Swarovski v krabičke**

Ø 11 x 141 mm (pero)  
180 x 40 x 20 mm (box)  
tampoprint, laserový popis

ks	1-14	15+	75+	150+
€	13,959	13,102	12,653	12,327



16273.B



16272.C

**SWAROVSKI  
ELEMENTS**



**16013.C**

**Guličkové pero MOSCOW  
s krištálkami Swarovski  
v darčekovej krabičke**

185 x 78 x 33 mm (box)  
tampoprint, laserový popis

ks	1-9	10+	50+	100+
€	17,388	16,327	15,755	15,388

**SWAROVSKI  
ELEMENTS**



**16012.C**

**Roller RIGA s krištálkami Swarovski  
v darčekovej krabičke**

185 x 78 x 33 mm (box)  
tampoprint, laserový popis

ks	1-9	10+	50+	100+
€	19,306	18,122	17,469	17,061

roller má čiernu náplň

**SWAROVSKI  
ELEMENTS**



**SWAROVSKI  
ELEMENTS**

**16015.C**

**Guličkové pero KIEV  
s krištálkami Swarovski na klípe  
v darčekovej krabičke**

185 x 78 x 33 mm (box)  
tampoprint, laserový popis

ks	1-19	20+	100+	200+
€	11,878	11,143	10,735	10,490



**36065.S**

**Darčekový na čierno písuci set rollera a guličkového pera PREMIER**

180 x 68 x 40 mm (box)  
tampoprint, laserový popis

ks	1-19	20+	100+	200+
€	12,957	11,957	11,087	10,348

**BALMAIN**  
PARIS



**Luxusné guličkové pero CHAMPAGNE v darčekovej kazete**

182 x 57 x 35 mm (box)  
tampoprint, laserový popis

ks	1-19	20+	100+	200+
€	9,469	8,898	8,571	8,367



16008.G

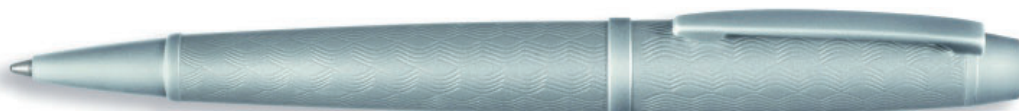

16007.S

**BALMAIN**  
PARIS

**36066.S**

**Značkové na čierno písuce kovové guličkové pero PREMIER**

180 x 50 x 40 mm (box)  
tampoprint, laserový popis

ks	1-29	30+	150+	300+
€	8,217	7,609	7,000	6,652







novinka

Darčeková sada plastového  
guličkového pera a hliníkovej kľúčenky

51293.S

162 x 90 x 20 mm (box)  
tampoprint, laserový popis (prívesok)

ks	1-119	120+	600+	1200+
€	1,600	1,539	1,483	1,448



51290.C



51292.R



51291.M



**BALMAIN**  
PARIS

Hliníková na čierno písuca sada  
guličkového pera a rollera ARLES

190 x 75 x 30 mm (box)  
tampoprint, laserový popis

ks	1-19	20+	100+	200+
€	9,826	9,435	9,130	8,913

35017.C



35018.M



35019.S

Drevené guľčkové pero v čiernom papierovom puzdre s výsekom

Ø 13 x 140 mm (pero) / 43 x 159 x 1 mm (puzdro)  
tampoprint, laserový popis

ks	1-119	120+	600+	1200+
€	1,796	1,730	1,665	1,626

29099.P



29098.P



80429.P

Drevená ostrúhaná miniceruzka s gumou

Ø 5 x 90 mm  
tampoprint, laserový popis

novinka



ks	1-2999	3 000+	15 000+	30 000+
€	0,057	0,052	0,050	0,048

43361.P

Drevené guľčkové pero

Ø 11 x 145 mm  
tampoprint, laserový popis

ks	1-149	150+	750+	1500+
€	1,300	1,204	1,152	1,087



29001.P

Bambusové guľčkové pero SUMATRA s kovovými doplnkami

Ø 11 x 135 mm  
tampoprint, laserový popis

ks	1-199	200+	1000+	2000+
€	0,978	0,943	0,909	0,887

Drevená ceruzka s gumou

Ø 7 x 190 mm  
tampoprint, laserový popis

ks	1-1999	2000+	6000+	12000+
€	0,083	0,078	0,074	0,070



41801.B



41802.S



41803.P

Dlhá drevená tesárska ceruzka s ťuhou tvrdosťou HB

240 x 12 x 6 mm  
tampoprint, laserový popis

ks	1-499	500+	2 500+	5 000+
€	0,387	0,378	0,370	0,361

kvalitná ceruzka českej výroby



91851.M



91850.B



91853.P



91852.R



91854.Y



16275.P

Sada guľičkového pera a mechanickej ceruzky PRECIOUS z orechového dreva v darčekovej čiernej krabičke s drevenými doplnkami

Ø 12 x 143 mm (pero)  
193 x 70 x 43 mm (box)  
tampoprint, laserový popis

ks	1-19	20+	100+	200+
€	11,714	11,020	10,612	10,367



43363.P

Sada guľičkového pera a mechanickej ceruzky v drevenej kazete

150 x 54 x 20 mm (box)  
tampoprint, laserový popis

ks	1-49	50+	250+	500+
€	3,891	3,674	3,448	3,283



42139.P

Drevená písacia súprava guľičkového pera a mechanickej ceruzky

170 x 55 x 20 mm (box)  
tampoprint, laserový popis

ks	1-29	30+	150+	300+
€	8,217	7,913	7,652	7,478



42151.P

Guľičkové pero so stojančekom

90 x 55 x 140 mm  
tampoprint, laserový popis

ks	1-49	50+	250+	500+
€	4,326	4,196	4,022	3,891



20792.P

Drevená pyramída  
s magnetom a spinkami

novinka

58 x 58 x 45 mm  
tampoprint, laserový popis

ks	1-69	70+	350+	700+
€	2,726	2,626	2,530	2,470

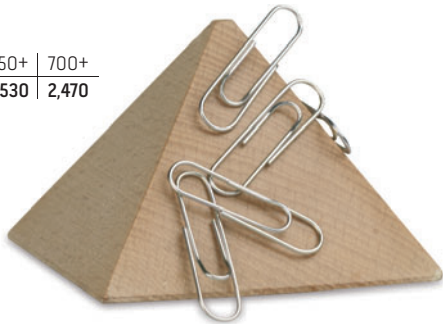

44926.T

Podsvietený stojan na perá/  
budík/teploměr/kancelária

78 x 115 x 57 mm  
tampoprint

ks	1-39	40+	200+	400+
€	4,343	4,126	3,909	3,691



44925.T

Stojan s multifunkčnými hodinami

100 x 118 x 50 mm  
tampoprint

ks	1-49	50+	300+	600+
€	3,804	3,639	3,470	3,357

42272.R



42270.B



Držiak na pero/magnetický  
zásobník, vrátane sponiek

Ø 80 x 25 mm  
tampoprint

ks	1-499	500+	2500+	5000+
€	0,430	0,404	0,387	0,374

42271.M



13313.Z

13311.R

13312.M

13314.O

30084.S

Stojan s memo klipom

25 x 115 x 25 mm  
tampoprint

ks	1-399	400+	2000+	4000+
€	0,487	0,465	0,452	0,439

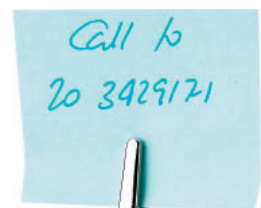

**erga**  
CREATING WORKS OF ART

LEO nalepovací stojáček  
s čiernymi písacimi náplňami

85 x 120 x 45 mm  
tampoprint

ks	1-149	150+	750+	1500+
€	1,252	1,126	1,070	1,022





42861.M

**Hliníkový stojan  
na mobilný telefón**
60 x 75 x 67 mm  
tampoprint, laserový popis

ks	1-149	150+	600+	1200+
€	1,735	1,600	1,487	1,387

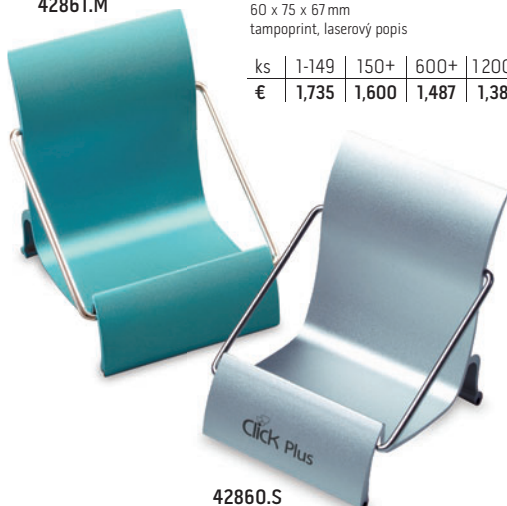

42860.S

30078.C

**Stojn na mobil  
s príľnavou podložkou  
a stylusom**

novinka

73 x 133 x 12 mm  
tampoprint

ks	1-39	40+	200+	400+
€	4,913	4,739	4,565	4,478



30088.S

**Stojan na mobil  
s príľnavou podložkou**
65 x 135 x 67 mm  
tampoprint

ks	1-79	80+	400+	800+
€	2,448	2,357	2,274	2,222



20743.0

**Skladací držiak  
na mobil**
90 x 62 x 97 mm  
tampoprint

ks	1-799	800+	4000+	8000+
€	0,243	0,235	0,226	0,222

vyklápacia plocha na odloženie  
mobilu pri dobíjaní

20744.C

20742.R

20741.M

49110.B

**Otvárač listov**
70 x 55 x 4 mm  
tampoprint

ks	1-599	600+	3000+	6000+
€	0,296	0,270	0,252	0,235

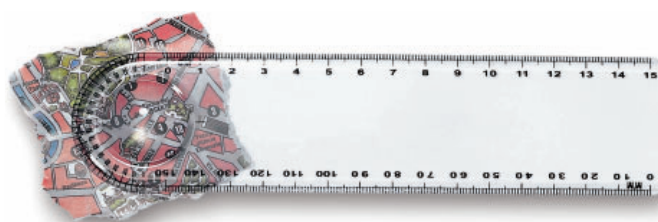

42274.T

**Pravítko 15 cm s lupou  
a uhlomerom**
185 x 45 x 3 mm  
tampoprint

ks	1-599	600+	3000+	6000+
€	0,257	0,239	0,222	0,204



42302.B

**Nalepovací memory klip**
61 x 21 x 15 mm  
tampoprint

ks	1-999	1000+	5000+	10000+
€	0,213	0,204	0,200	0,196

42273.B

**Pravítko 30 cm**
300 x 30 x 3 mm  
tampoprint

ks	1-499	500+	2500+	5000+
€	0,291	0,270	0,248	0,235

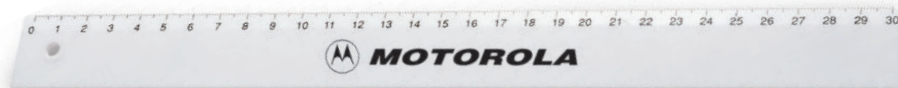

BALMAIN  
PARISPoznámkový blok BALMAIN  
PARIS s elastickým zatváraním,  
80 linajkových listov

tampoprint, sieťotlač

A5	formát A5	ks	1-29	30+	150+	300+
		€	8,565	8,261	7,957	7,783

A6	formát A6	ks	1-39	40+	200+	400+
		€	4,870	4,696	4,522	4,435



Poznámkové bloky BALMAIN PARIS s elastickým zatváraním, 80 linajkových listov

formát/farba	rozmer	biely	fialový	čierny
A5	147 x 213 x 12 mm	38337.B	38338.F	38339.C
A6	89 x 144 x 12 mm	38327.B	38328.F	38329.C

80 linajkových listov bielej farby  
gramáže 80 g/m<sup>2</sup>, pútka na pero.

novinka

Vertikálny poznámkový blok s elastickým  
zatváraním, 80 linajkových listov90 x 143 x 13 mm  
tampoprint, sieťotlač

ks	1-119	120+	600+	1200+
€	1,583	1,526	1,470	1,435



28353.O



28350.C



28351.M



28352.R



28354.Z

80 linajkových listov krémovej farby gramáž 70 g/m<sup>2</sup> z recyklovaného papiera.

38315.B

A5 Poznámkový blok s guličkovým perom  
formátu A5, 80 linajkových listov160 x 210 x 10 mm  
tampoprint, sieťotlač

ks	1-99	100+	500+	1000+
€	1,917	1,848	1,783	1,739

80 linajkových listov gramáže 60 g/m<sup>2</sup>  
v bielej farbe, na čierno píšece plastové  
guličkové pero vo farbe bloku.

38317.C

37981.S

Poznámkový bločik s na čierno  
píšucim guličkovým perom80 x 108 x 12 mm  
tampoprint

ks	1-149	150+	750+	1500+
€	1,235	1,187	1,148	1,122



37989.C

Koženkové puzdro  
na kreditky s blokom  
a pútkom na pero90 x 135 x 15 mm  
tampoprint, razba

ks	1-99	100+	500+	1000+
€	1,722	1,657	1,596	1,561

40 nelinajkových bielych listov.



novinka



32 linajkových listov krémovej farby gramáž 70 g/m<sup>2</sup>.

novinka

## A5 Poznámkový blok formátu A5 s pevnými papierovými doskami, 32 linajkových listov

142 x 210 x 5 mm  
tampoprint, sieťotlač

ks	1-139	140+	700+	1400+
€	1,387	1,335	1,287	1,257



20793.C



20794.M



20795.R



20796.O



20797.Z

## A4 Poznámkový blok s elastickým zatváraním formátu A4

tampoprint, sieťotlač

ks	1-29	30+	150+	300+
€	6,652	6,391	6,174	6,043

## A5 Poznámkový blok s elastickým zatváraním formátu A5

tampoprint, sieťotlač

ks	1-49	50+	250+	500+
€	3,883	3,735	3,604	3,522

## A6 Poznámkový blok s elastickým zatváraním formátu A6

tampoprint, sieťotlač

ks	1-79	80+	400+	800+
€	2,426	2,335	2,252	2,200



JOURNALBOOKS®

Poznámkové bloky JOURNALBOOKS® s elastickým zatváraním, 80 linajkových listov

formát/farba	rozmer	čierny	modrý	červený	strieborný
A4	209 x 298 x 12 mm	38340.C	38341.M	38342.R	38343.S
A5	145 x 213 x 12 mm	38330.C	38331.M	38332.R	38333.S
A6	95 x 140 x 15 mm	38320.C	38321.M	38322.R	38323.S

Luxusné dosky, 80 linajkových listov krémovej farby gramáže 80 g/m<sup>2</sup>.

## A5 Poznámkový blok formátu A5 s guličkovým perom, 70 linajkových listov

130 x 180 x 7 mm  
tampoprint, sieťotlač

70 linajkových listov v bielej farbe, na modro písuce kartónové guličkové pero vo farbe bloku.

ks	1-89	90+	450+	900+
€	2,152	2,074	2,000	1,952

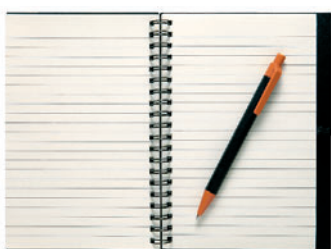

29081.Z



29080.M



29082.O



**42816.C**  
Čierny kožený box  
s papieríkmi na poznámky

93 x 93 x 27 mm  
tampoprint, sieťotlač

ks	1-149	150+	750+	1500+
€	1,278	1,178	1,096	1,022

vrátane prehľadného  
kalendára 2012–2015



**42815.B**  
Memory set

80 x 106 x 18 mm  
tampoprint

ks	1-199	200+	1000+	2000+
€	0,857	0,796	0,761	0,726



Farebné lepiace lístky v obale,  
5 farieb

82 x 58 x 4 mm  
tampoprint

ks	1-699	700+	3500+	7000+
€	0,309	0,296	0,287	0,278

30077.B



30076.C

Zásobník na papier  
a perá (bez náplne)

105 x 105 x 70 mm  
tampoprint, sieťotlač

ks	1-299	300+	1200+	3000+
€	0,987	0,922	0,874	0,843

46054.M

46053.B

46055.R



51392.C

Praktická sada s bielym bločkom,  
farebnými a signálnymi lístkami

83 x 128 x 13 mm  
tampoprint, sieťotlač

ks	1-199	200+	1000+	2000+
€	0,965	0,926	0,896	0,874



46201.B

Náplň do zásobníka 46053-55

75 x 100 x 60 mm  
cca 500 lístkov

ks	1-299	300+	1200+	3000+
€	1,287	1,235	1,191	1,148





novinka

## Písacia podložka A4 s klipom

230 x 315 x 5 mm  
sietotlač

ks	1-49	50+	250+	500+
€	3,039	2,926	2,822	2,748



80503.C



80500.B



80501.R



80502.M



## Lepiace lístky



Kompletný sortiment lepiacich lístkov a ich ceny nájdete na našich webových stránkach pod kódami 88\*.



## 42811.P

## Kartónový box vrátane lístkov

110 x 73 x 37 mm  
tampoprint

ks	1-199	200+	1000+	2000+
€	1,009	0,930	0,865	0,804

## 42812.P

## Kartónový box vrátane lístkov

125 x 127 x 34 mm  
tampoprint, sietotlač

ks	1-119	120+	600+	1200+
€	1,457	1,378	1,300	1,239



Poznámkový blok, 50 lístkov, vrátane jedno alebo dvojfarebnej potlače, lepený v hlave, biely ofsetový papier 80 g/m<sup>2</sup>, kartónová podložka

od 0,<sup>665</sup>

## Lepené poznámkové bloky s potlačou všetkých strán bloku

kód	rozmer	potlač	od 250 ks	od 500 ks	od 1000 ks	od 2500 ks
90101.B	148 x 210 mm (A5)	1/0	0,935	0,804	0,731	0,665
90102.B	148 x 210 mm (A5)	2/0	1,180	0,951	0,853	0,755
90111.B	210 x 297 mm (A4)	1/0	1,498	1,318	1,212	1,122
90112.B	210 x 297 mm (A4)	2/0	1,776	1,588	1,408	1,294
Technická príprava výroby			33 €/farba			

Iné formáty lepených blokov, iné počty lístkov v bloku či viacfarebné potlače sú k dispozícii na webe alebo na vyžiadanie, už od 250 ks.

**44116.K**

Elegantný tmavošedý vizitkár  
v kombinácii lesk/mat

novinka

93 x 60 x 7 mm  
tampoprint, laserový popis

ks	1-99	100+	500+	1000+
€	1,991	1,839	1,709	1,591

**44117.C**

Vizitkár v kombinácii tmavošedý  
kov/umelá koža so zamatovou  
výstelkou a magnetom

novinka

94 x 65 x 14 mm  
tampoprint, laserový popis

ks	1-79	80+	400+	800+
€	2,552	2,357	2,187	2,043

**44112.S**

Vizitkár v kombinácii  
lesklý kov/matný hliník

93 x 62 x 10 mm  
tampoprint, laserový popis

ks	1-99	100+	500+	1000+
€	2,013	1,861	1,726	1,613

**44115.G**

Matný zlatý hliníkový vizitkár

94 x 60 x 5 mm  
tampoprint, laserový popis

ks	1-149	150+	750+	1500+
€	1,300	1,239	1,204	1,170



Vizitkare sú balené  
jednotlivo v krabíčkách.

**44113.S**

Vizitkár v kombinácii  
lesklý kov/matný hliník

93 x 62 x 6 mm  
tampoprint, laserový popis

ks	1-99	100+	500+	1000+
€	1,735	1,652	1,583	1,548

**44111.S**

Vizitkár v kombinácii  
lesklý kov/matný hliník

93 x 62 x 6 mm  
tampoprint, laserový popis

ks	1-99	100+	500+	1000+
€	1,735	1,652	1,583	1,548

**44101.S**

Lesklý vizitkár  
z chrómovanej mosadze

93 x 59 x 5 mm  
tampoprint, laserový popis

ks	1-149	150+	600+	1200+
€	1,626	1,543	1,474	1,439

**44102.S**

Matný vizitkár  
z chrómovanej mosadze

93 x 59 x 5 mm  
tampoprint, laserový popis

**50909.S**

Hliníkový vizitkár

94 x 60 x 5 mm  
tampoprint, laserový popis

ks	1-199	200+	1000+	2000+
€	0,843	0,813	0,783	0,765





35571.S

Ťažítko ruleta

Ø 50 x 50 mm  
laserový popis

ks	1-29	30+	150+	300+
€	7,391	7,130	6,870	6,696

deväť odpovedí: Go for it, You are fired, Go home, Bonus, Get a job, Take a break, Yes, No, Maybe



16132.Q

Funkčná miniatúra golfového vozíka ako kancelársky stojanček

130 x 90 x 155 mm

ks	1-9	10+	50+	100+
€	20,816	19,510	18,816	18,408



vrátane 3 farebných pier  
v tvare golfových palíc



16131.C

Vizitkár v kombinácii kov/umelá koža s magnetickým klipom

99 x 69 x 18 mm  
tampoprint, laserový popis

ks	1-59	60+	300+	600+
€	3,457	3,245	3,127	3,057



42289.Q

Čínske antistresové gule

140 x 100 x 65 mm  
tampoprint, laserový popis

ks	1-39	40+	200+	400+
€	6,043	5,696	5,348	5,087



28301.S

Lupa v puzdre z hliníka

Ø 71 x 15 mm  
tampoprint, laserový popis

ks	1-29	30+	150+	300+
€	7,478	7,217	6,957	6,783



42844.S

Stresskiller, magnet a 200 kovových guľičiek

90 x 70 x 23 mm  
tampoprint

ks	1-149	150+	600+	1200+
€	1,735	1,600	1,487	1,387

200 guľičiek, ktoré magnet udrží  
v najrôznejších pozíciách



28302.S

Obdĺžniková lupa s LED svetlom a guľčikovým perom

80 x 50 x 6 mm  
tampoprint

ks	1-119	120+	600+	1200+
€	1,617	1,557	1,500	1,465



Tento unikátny mikrovláknový čistič je vyrobený na hornej strane zo špeciálneho mikrovlákná, určeného na čistenie dotykových displejov, okuliarov, obrazoviek atď. Spodná časť je opatrená špeciálnou príľnavou vrstvou, takže ho môžete nosiť nepretržite na mobilnom telefóne.

28 x 28 mm (čistič) / 54 x 90 mm (blister) / 60 x 119 mm (polybag)  
digitálna tlač

od 0,731



42260.Q

Unikátny mikrovláknový čistič – plnofarebná tlač hornej strany a univerzálny blister



hnedá

modrá

zelená

Čističe dodávame štandardne v univerzálnom blistri – viď foto – obj. kód 42260.Q. Univerzálne blistre sú štandardne v hnedom, modrom či zelenom dizajne (farbu, prosím, upresnite pri objednávke).

Unikátny mikrovláknový čistič s plnofarebnou potlačou a blistrom	
počet kusov	cena za kus
500-999 ks	1,163
1 000-1 499 ks	1,082
1 500-1 999 ks	1,016
2 000-2 999 ks	0,910
3 000-3 999 ks	0,812
4 000-4 999 ks	0,755
5 000 a viac ks	0,731
Technická príprava tlače	12 €

Plnofarebná tlač hornej mikrovláknovej časti je zahrnutá v cene.

Výroba vzorky s univerzálnym blistrom za paušálny príplatok 40 €.

Pri modeli 42261.Q paušálny príplatok 123 € za tlač blistra s vlastnou grafikou.

42261.Q

Unikátny mikrovláknový čistič – plnofarebná tlač hornej strany a blister s vlastnou grafikou



Na zákazku vám čističe dodáme v blistri s vlastnou grafikou – obj. kód 42261.Q za paušálny príplatok 123 €.



90141.B

Biele mikrovláknová utierka na okuliare, monitory a jemnú optiku v puzdre

utierka: 90 x 150 mm  
biele papierové puzdro: 70 x 110 mm  
tampoprint, sieťotlač (na puzdro)

ks	1-299	300+	1000+	4000+
€	0,713	0,657	0,609	0,570



Mikrovláknové utierky s plnofarebnou potlačou		
počet kusov/tlač	jednostranná	obojsstranná
300-499 ks	1,180	1,380
500-999 ks	0,971	1,171
1000-1499 ks	0,865	1,065
1500-1999 ks	0,771	0,971
2000-2999 ks	0,735	0,935
3000-3999 ks	0,678	0,878
4000-4999 ks	0,637	0,837
5000 a viac ks	0,608	0,808
Technická príprava tlače	12 €/1 strana	

Cena je uvedená za utierku s jedno- či obojsstrannou tlačou totožným logom.

Výroba vzorky za paušálny príplatok 40 €.

Utierky vrátane digitálnej tlače sú štandardne balené v polybague, papierové puzdro za príplatok 0,22 €/kus.



90140.Q

Mikrovláknové utierky s plnofarebnou potlačou

90 x 150 mm  
digitálna tlač

od 0,608

**Obal na iPhone z imitácie kože  
s magnetickým uzáverom**

 60 x 120 x 10 mm  
tampoprint, laserový popis

ks	1-49	50+	250+	500+
€	4,078	3,926	3,787	3,700



28358.C

28357.H

28359.J

**28319.C**
**Obal na iPad – 10"  
z imitácie kože**

 200 x 250 x 20 mm  
sietotlač, transfer

ks	1-14	15+	75+	150+
€	11,783	11,348	10,957	10,696

 Služí zároveň ako stojan  
a elastický pásik umožňuje  
pripevnenie k opierke v aute.

**všetko  
novinky**
**28318.B**
**Skladací stojan na tablet  
či telefón so silikónovým hrotom**

 260 x 210 x 10 mm  
tampoprint

ks	1-299	300+	1500+	3000+
€	0,617	0,596	0,574	0,561

**28317.J**
**Neoprénové puzdro na iPad – 10"**

 260 x 215 x 10 mm  
sietotlač, transfer

ks	1-49	50+	250+	500+
€	4,435	4,257	4,104	4,009



28316.C

**80510.S**
**Plastový stylus s čistiacou utierkou**

 Ø 10 x 105 mm  
tampoprint

ks	1-299	300+	1500+	3000+
€	0,604	0,578	0,557	0,543

**Plastový stylus  
s 3,5mm jack konektorom**

 Ø 8 x 48 mm  
tampoprint

ks	1-599	600+	3000+	6000+
€	0,300	0,291	0,283	0,274



80504.O

80506.M

80507.Z

80508.C

80509.S

80505.R



# Drobné darčeky

Štandardná veľkosť:  
Držiaky na mince a žetóny  
v hodnote 0,50 €



**44202.S**  
Lesklý držiak na mincu  
alebo žetón

30 x 45 x 5 mm  
tampoprint, laserový popis

ks	1-299	300+	1500+	3000+
€	0,865	0,822	0,778	0,735



**44201.S**  
Matný držiak na mincu  
alebo žetón

30 x 45 x 5 mm  
tampoprint, laserový popis

ks	1-299	300+	1500+	3000+
€	0,865	0,822	0,778	0,735

Zákazkové žetóny s držiakmi  
môžeme dodať aj vo veľkosti  
1 € (od 1000 ks)



**44204.S**  
Lesklý kovový žetón  
(veľkosť 0,50 €)

tampoprint, laserový popis

ks	1-799	800+	4000+	8000+
€	0,300	0,287	0,270	0,252



**44203.S**  
Lesklý držiak na mincu  
alebo žetón

30 x 50 x 5 mm  
tampoprint, laserový popis

ks	1-199	200+	1000+	2000+
€	0,909	0,865	0,822	0,778



**44205.C**  
Darčeková krabička  
na uzavretý držiak

**44209.C**  
Darčeková krabička  
na otvorený držiak

60 x 110 x 10 mm  
tampoprint

ks	1-599	600+	3000+	6000+
€	0,335	0,309	0,287	0,270



Príklady žetónu s razbou

Žetóny s razbou podľa predlohy klienta

500–999 ks	0,822
1000–1999 ks	0,778
2000–4999 ks	0,691
5000–9999 ks	0,457
10000 a viac ks	0,415

Zhotovenie formy: 80 €/strana alebo motív  
(formy nie sú archivované).  
Technická príprava opakovanej výroby žetónov  
s razbou: 50 €/strana alebo motív.  
Kusová cena je rovnaká pre jednostrannú  
aj obojstrannou razbu.

Žetóny s razbou  
podľa predlohy klienta

od 0,415



• montáž žetónu do držiaka  
a balenie do krabičky  
za príplatok +0,12 €/kus

• montáž žetónu do držiaka  
za príplatok: +0,02 €/žetón



novinka

42943.K

Kovový tmavošedý príviesok  
v kombinácii lesk/mat  
v darčekovej krabičke

44 x 27 x 6 mm  
tampoprint, laserový popis

ks	1-149	150+	750+	1500+
€	1,278	1,178	1,096	1,022



42944.K

Kovový tmavošedý príviesok  
v kombinácii lesk/mat  
v darčekovej krabičke

Ø 37 x 5 mm  
tampoprint, laserový popis

ks	1-149	150+	750+	1500+
€	1,148	1,061	0,983	0,917

novinka



42929.S

Dvojdielny odopínací  
matný kovový príviesok  
na kľúče

70 x 25 x 5 mm  
tampoprint, laserový popis

ks	1-199	200+	1000+	2000+
€	1,126	1,083	1,022	0,957



16246.S

Kovový príviesok so žetónom  
v darčekovej krabičke

32 x 50 x 4 mm  
tampoprint, laserový popis

ks	1-99	100+	500+	1000+
€	1,882	1,767	1,702	1,661

42935.S

Kovový príviesok  
v darčekovej krabičke

46 x 20 x 4 mm  
tampoprint, laserový popis

ks	1-199	200+	1000+	2000+
€	0,952	0,909	0,865	0,848



42945.S

Kovový príviesok  
v darčekovej krabičke

65 x 20 x 2 mm  
tampoprint, laserový popis

ks	1-199	200+	1000+	2000+
€	0,952	0,909	0,865	0,848



42932.S

Kovový príviesok  
v darčekovej krabičke

51 x 28 x 2 mm  
tampoprint, laserový popis

ks	1-199	200+	1000+	2000+
€	0,952	0,909	0,865	0,848



42936.S

Kovový príviesok  
v darčekovej krabičke

47 x 16 x 5 mm  
tampoprint, laserový popis

ks	1-199	200+	1200+	2500+
€	0,909	0,865	0,822	0,778





16140.S

Kovový prívesok na kľúče Leni  
v darčekovej krabičke

34 x 83 x 18 mm  
tampoprint, laserový popis

ks	1-89	90+	450+	900+
€	2,167	2,033	1,959	1,914



51388.S

Kovový prívesok Domček  
v darčekovej krabičke

35 x 40 x 3 mm  
tampoprint, laserový popis

ks	1-199	200+	1 000+	2 000+
€	1,239	1,191	1,152	1,122

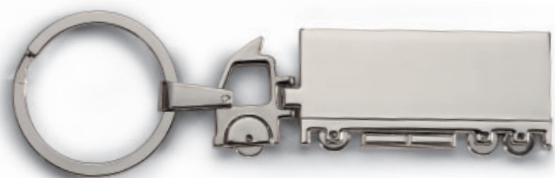

51387.S

Kovový prívesok Truck  
v darčekovej krabičke

70 x 25 x 8 mm  
tampoprint, laserový popis

ks	1-129	130+	650+	1 300+
€	1,517	1,461	1,409	1,374



42938.S

Kovový prívesok  
v darčekovej krabičke

56 x 21 x 5 mm  
tampoprint, laserový popis

ks	1-199	200+	1 000+	2 000+
€	1,126	1,083	1,022	0,957



51375.R

Kovový prívesok  
s farebnou plochou

27 x 43 x 6 mm  
tampoprint, laserový popis

ks	1-299	300+	1 500+	3 000+
€	0,735	0,709	0,683	0,665



51373.C



51374.M



51376.S



51350.C



51353.R



51354.B



51355.O



51357.Z



51351.M

Silikónová kľúčenka  
s kovovým štítkom

12 x 102 mm  
tampoprint, laserový popis

ks	1-199	200+	1 000+	2 000+
€	0,848	0,817	0,787	0,770





60126.S

Kovový zapalovač  
v prívesku40 x 70 x 9 mm  
tampoprint, laserový popis

ks	1-49	50+	250+	500+
€	4,304	4,130	3,957	3,765



16154.C

Prívesok Label s kovovou plochou

107 x 33 x 7 mm  
tampoprint, laserový popis

ks	1-139	140+	700+	1400+
€	1,355	1,273	1,229	1,200



42941.S

Fľaška  
ako prívesok41 x 60 x 21 mm  
tampoprint, laserový popis

ks	1-99	100+	600+	1200+
€	1,996	1,952	1,865	1,735



51380.R

Koženková kľúčienka  
s kontrastným prešíťím25 x 47 x 4 mm  
tampoprint, razba

ks	1-199	200+	1000+	2000+
€	1,143	1,100	1,061	1,035



51377.H



51378.C



51379.M



42942.M

Prívesok na kľúče s kryštálom

31 x 29 x 7 mm  
tampoprint

ks	1-599	600+	3000+	6000+
€	0,230	0,213	0,200	0,187

46106.T  
40 x 40 x 5 mm46107.T  
40 x 30 x 5 mmDvojielny plexi  
prívesok s krúžkom

ofset

ks	1-499	500+	3000+	6000+
€	0,430	0,413	0,396	0,378

Prívesky 4610x.T sú dodávané  
v rozloženom stave.



novinka

Hliníková minibaterka  
s 1x LED svetlom a karabínkou

Ø 20 x 54 mm  
tampoprint, laserový popis

ks	1-99	100+	500+	1000+
€	1,830	1,761	1,700	1,661



33975.S

33976.R

33977.M



80281.M

Hliníková minibaterka  
s 3x LED svetlom a karabínkou

Ø 17 x 50 mm  
tampoprint, laserový popis

ks	1-119	120+	600+	1200+
€	1,613	1,543	1,483	1,448



80282.C

80280.R

80283.S

33990.M

33991.C

33989.R

33987.S



Prívesok s LED baterkou

60 x 24 x 5 mm  
tampoprint

ks	1-399	400+	2000+	4000+
€	0,552	0,530	0,513	0,500

Prívesok s modrým LED svetlom

Ø 50 x 16 mm  
tampoprint

ks	1-299	300+	1500+	3000+
€	0,591	0,548	0,509	0,474



42652.Z



42651.R

42650.M

**Multifunkčný kovový privesok  
s LED svetlom, 7 funkcií**

 60 x 30 x 16 mm  
tampoprint, laserový popis

ks	1-39	40+	200+	400+
€	4,913	4,739	4,565	4,478

33999.S

 nová  
farba

34000.C



novinka

52368.C

**Kľúčienka v tvare autokľúča s LED svetlom  
a na modro písucim guličkovým perom**

 38 x 68 x 18 mm  
tampoprint

ks	1-149	150+	750+	1500+
€	1,291	1,243	1,196	1,170



42889.S

**Privesok s LED baterkou  
v darčekovej krabičke**

 Ø 16 x 68 mm  
tampoprint, laserový popis

ks	1-119	120+	600+	1200+
€	1,683	1,557	1,443	1,348



42899.S

**Privesok s LED  
baterkou v krabičke**

 Ø 12 x 52 mm  
tampoprint, laserový popis

ks	1-119	120+	600+	1200+
€	1,683	1,557	1,443	1,348



Privesok so svetlom

 96 x 34 x 12 mm  
tampoprint

ks	1-399	400+	2.000+	4.000+
€	0,448	0,413	0,383	0,357

42640.S

**Baterka ako privesok**

 113 x 19 x 19 mm  
tampoprint

ks	1-499	500+	3.000+	6.000+
€	0,387	0,365	0,343	0,322



42632.R

42631.M



UNO držiak na žetón veľkosti (0,50 €)  
(žetón dodávame samostatne  
pod kódom 4424x)

30 x 45 x 5 mm  
tampoprint

ks	1-599	600+	3 000+	6 000+
€	0,343	0,322	0,296	0,278



Žetón pre držiak UNO  
(0,50 €)

tampoprint

ks	1-2999	3 000+	15 000+	30 000+
€	0,070	0,065	0,061	0,052

iná farba žetónu 4424x  
na dopyt (od 100 ks)



44242.M  
modrá

46068.M

46065.B



špeciálne farebné  
kombinácie na  
dopyt (od 100 ks)



ZERO držiak na žetón veľkosti  
0,50 €, veľká plocha pre tlač  
(žetóny dodávame samostatne  
pod kódom 90269.B)

30 x 47 x 4 mm  
tampoprint

ks	1-999	1 000+	4 000+	12 000+
€	0,204	0,191	0,183	0,174



Prívesok vrátane žetónu  
(0,50 €)

bez krúžku  
50 x 30 x 4 mm  
tampoprint

ks	1-799	800+	4 000+	8 000+
€	0,235	0,217	0,200	0,187

cena krúžku vrátane  
montáže: +0,14 €/kus

90268.B  
1 €

Bielý žetón pre držiak DUE

tampoprint

90269.B  
0,50 €

Bielý žetón pre držiaky ZERO a DUE

tampoprint

ks	1-2999	3 000+	12 000+	40 000+
€	0,070	0,065	0,061	0,052

montáž do držiakov +0,015 €/žetón  
ostatné farby na dopyt (po 250 ks)

90261.B



90262.C



90263.M



DUE držiak na dva žetóny  
1 € a 0,50 €  
(žetóny dodávame samostatne  
pod kódom 90268.B a 90269.B)

30 x 28 x 10 mm

ks	1-999	1 000+	5 000+	15 000+
€	0,170	0,161	0,152	0,148



90264.R



90265.Y



90266.Z



37324.B 37325.R 37326.E  
37327.M 37328.Z 37329.Y

novinka

Lhké slúchadlá s 3,5mm jackom v praktickom obale

72 x 72 x 22 mm (box)  
tampoprint

ks	1-39	40+	200+	400+
€	4,913	4,739	4,565	4,478



37323.C



52382.R



52381.M



52380.C



52383.B

Sada dvoch káblových držiakov v priesvitnom boxe

73 x 40 x 18 mm (box)  
tampoprint

ks	1-199	200+	1000+	2000+
€	0,930	0,896	0,865	0,843

novinka

Jedna strana žetónu je farebná, na druhej je vyrazený nákupný vozík.



80420.B 80423.R  
80424.M 80426.C



80427.E 80425.Z 80421.Y 80422.O



Kovový príviesok so žetónom 1 €

tampoprint, laserový popis

novinka

ks	1-394	395+	1975+	5925+
€	0,491	0,470	0,452	0,439

Kovová píšťalka na príviesku

Ø 9 x 46 mm  
tampoprint, laserový popis

ks	1-499	500+	3000+	6000+
€	0,387	0,365	0,343	0,322



42636.R



42637.C



42635.M

33983.T

Príviesok na kľúče s vodovähou

15 x 15 x 40 mm  
tampoprint

ks	1-499	500+	2500+	5000+
€	0,439	0,426	0,409	0,400





37331.M

novinka

Hliníkový prívesok s otváračom a káblovým držiakom

65 x 25 x 3 mm  
tampoprint, laserový popis

ks	1-699	700+	3500+	7000+
€	0,309	0,296	0,287	0,278



37330.C



37332.S

Otvárač PET fliaš

80 x 38 x 15 mm  
tampoprint

ks	1-599	600+	3000+	8000+
€	0,322	0,300	0,287	0,274



nová farba

33982.M



33981.S

33980.C

Hliníkový prívesok s otváračom fliaš a plechoviek

55 x 10 x 15 mm  
tampoprint, laserový popis

ks	1-799	800+	4000+	8000+
€	0,265	0,257	0,248	0,239

90210.B



90211.M

Otvárač/uzáver na fľaše

95 x 41 x 10 mm  
tampoprint

ks	1-799	800+	4000+	8000+
€	0,257	0,239	0,222	0,204



49101.C

49103.M

49102.R

49104.Z

49112.M



49114.Y

49113.R

49111.B

49115.Z

Otvárač/uzáver na fľaše

95 x 45 x 12 mm  
tampoprint

ks	1-999	1000+	5000+	10000+
€	0,217	0,209	0,200	0,196



80417.R

novinka

Mikrovláknový obal  
na mobilný telefón80 x 133 x 3 mm  
transfer

ks	1-179	180+	900+	2700+
€	1,091	1,048	1,009	0,983



80419.C



80418.M

16253.C

Držiak na telefón  
Stand By Me s prísavkou

novinka

45 x 34 x 19 mm  
tampoprint

ks	1-299	300+	1500+	3000+
€	0,592	0,555	0,535	0,522



42543.P

Kovový otvárač  
s drevenou rúčkou115 x 20 x 15 mm  
tampoprint, laserový popis

ks	1-59	60+	300+	600+
€	3,022	2,787	2,591	2,417



16249.C

Čašnícky nôž Service  
v čiernej darčekovej krabičke140 x 30 x 10 mm  
tampoprint

ks	1-39	40+	200+	400+
€	4,490	4,245	4,078	3,984

52377.M



52375.R



52376.C

Vývrtka/otvárač na fľaše

111 x 13 mm  
tampoprint

ks	1-129	130+	650+	1300+
€	1,483	1,430	1,378	1,348



42544.S

Kovový čašnícky otvárač  
s matnou rúčkou110 x 20 x 10 mm  
tampoprint, laserový popis

ks	1-149	150+	750+	1500+
€	1,274	1,239	1,187	1,152



**37301.C**  
Multifunkčný nôž DUNLOP  
v polyesterovom puzdre

100 x 60 x 20 mm  
tampoprint, transfer

ks	1-19	20+	100+	200+
€	9,261	8,913	8,609	8,391

**42545.S**

Matný kovový nôž

75 x 25 x 6 mm  
tampoprint, laserový popis

ks	1-149	150+	750+	1500+
€	1,274	1,239	1,187	1,152



**34448.C**

Vreckový nôž MARKSMAN  
s poistkou v darčekovej krabičke

180 x 27 x 14 mm  
tampoprint, laserový popis

ks	1-9	10+	50+	100+
€	17,261	16,609	16,043	15,652

novinka



MARKSMAN

**42522.S**

Kovový nôž s jedenástimi funkciami

87 x 18 x 13 mm  
tampoprint, laserový popis

ks	1-99	100+	500+	1000+
€	2,022	1,943	1,870	1,800



**42523.S**

Armádný nôž  
so sedemnástimi funkciami

90 x 30 x 28 mm  
tampoprint, laserový popis

ks	1-69	70+	350+	700+
€	2,913	2,652	2,478	2,348

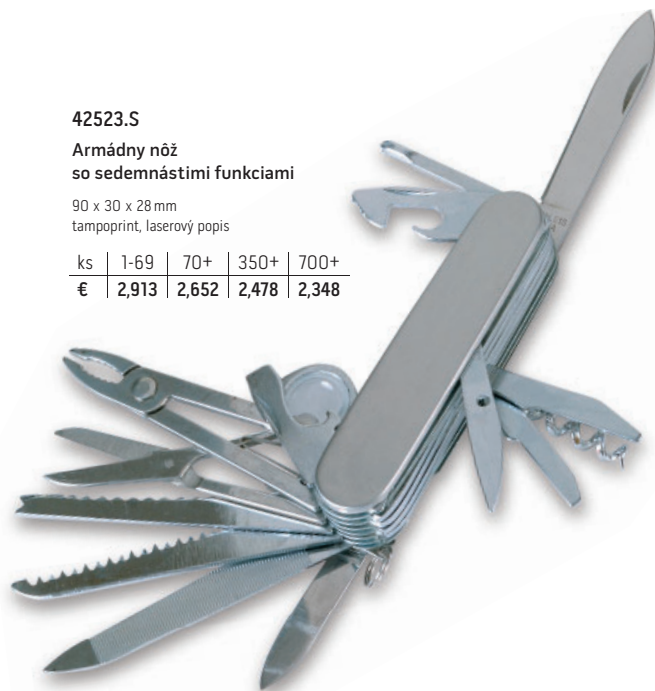



**16251.S****Zatvárací nůž Outback  
s klipom na opasok**110 x 30 x 15 mm  
tampoprint, laserový popis

ks	1-29	30+	150+	300+
€	7,265	6,816	6,571	6,408

**16252.P****Zatvárací nůž Prestige s puzdrom**112 x 28 x 19 mm  
tampoprint, laserový popis

ks	1-29	30+	150+	300+
€	7,673	7,184	6,939	6,776

**42509.P****Nůž s piatimi funkciami**90 x 25 x 15 mm  
tampoprint, laserový popis

ks	1-119	120+	600+	1200+
€	1,635	1,509	1,400	1,309

**16152.C****Zatvárací kovový nůž Black Cut  
s klipom a poistkou**115 x 30 x 15 mm  
tampoprint, laserový popis

ks	1-19	20+	100+	200+
€	9,265	8,694	8,367	8,163

**42533.S****Nůž s jedenástimi funkciami**88 x 22 x 20 mm  
tampoprint, laserový popis

ks	1-99	100+	500+	1000+
€	2,326	2,170	2,013	1,878





42540.P

**Bodyguard ozubená dýka  
v hnedom koženom puzdre**

225 x 35 x 25 mm  
tampoprint, laserový popis, razba

ks	1-29	30+	150+	450+
€	6,826	6,304	5,870	5,435



42552.P

**Lovecký nôž s klipom a poistkou**

122 x 31 x 20 mm  
tampoprint, laserový popis

ks	1-49	50+	250+	500+
€	5,609	5,174	4,783	4,478



42528.P

**Lovecký nôž s poistkou**

110 x 30 x 17 mm  
tampoprint, laserový popis

ks	1-29	30+	150+	525+
€	6,043	5,565	5,174	4,826



42524.P

**Štíhly zatvárací nôž**

102 x 20 x 10 mm  
tampoprint, laserový popis

ks	1-59	60+	300+	600+
€	3,804	3,513	3,261	3,043



**42560.P**

Vystreľovací nôž s klipom na opasok

125 x 40 x 12 mm  
tampoprint, laserový popis

ks	1-39	40+	200+	400+
€	6,043	5,652	5,348	5,174

**42551.P**

Vystreľovací nôž s LED baterkou

112 x 32 x 17 mm  
laserový popis

ks	1-39	40+	200+	400+
€	5,174	4,739	4,391	4,117



LAGUIOLE®

**35833.P**Drevený nožík LAGUIOLE  
ako príviesok98 x 42 x 10 mm  
tampoprint, laserový popis

ks	1-39	40+	200+	400+
€	5,565	5,348	5,174	5,043

**42534.P**

Lovecký nôž s poistkou

110 x 25 x 15 mm  
tampoprint, laserový popis

ks	1-39	40+	200+	600+
€	5,174	4,739	4,391	4,130

**42525.P**

Lovecký nôž s poistkou

105 x 35 x 15 mm  
tampoprint, laserový popis

ks	1-39	40+	200+	400+
€	5,609	5,174	4,826	4,478



**42555.P**  
Lovecký nôž s poistkou  
v drevenom boxe

140 x 60 x 32 mm (box)  
tampoprint, laserový popis

ks	1-29	30+	150+	300+
€	7,348	6,826	6,478	6,130



**35831.Q**  
Multifunkčný nôž

110 x 75 x 30 mm (box)  
tampoprint, laserový popis

ks	1-39	40+	200+	400+
€	5,609	5,261	4,913	4,652



**42547.C**  
Sada noža a otvárača

150 x 103 x 21 mm  
tampoprint, laserový popis

ks	1-49	50+	250+	500+
€	5,609	5,174	4,783	4,478



**35854.C**  
Dvojdielna sada na víno  
v čiernej darčekovej krabičke

135 x 83 x 25 mm (box)  
tampoprint, laserový popis

ks	1-59	60+	300+	600+
€	3,461	3,335	3,213	3,139



## SWISSCARD

Karty vo všetkých verziách obsahujú základnú sadu náradia a potrebných drobností. Stačí si potom už len vybrať, či preferujete nožičky, multifunkčný skrutkovač, baterku alebo pilník. Značková švajčiarska kvalita zaručuje vynikajúce funkčné vlastnosti. Veľkosť kreditnej karty umožňuje mať SwissCard stále pri sebe.

Výborná plocha pre reklamnú dotlač robí z tohto predmetu ideálny reklamný darček. Ďalšie farebné kombinácie na vyžiadanie.

### Funkcie SWISSCARD

1. nôž/otvárač listov



2. multifunkčný skrutkovač (hrany 3 a 5 mm, 2 krížové skrutkovače)



3. nožnice



4. špendlík z nerez ocele

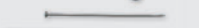

5. pilník/skrutkovač



6. pinzeta



7. špáradlo



8. guľičkové pero

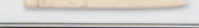

9. pravítko (cm a palce)

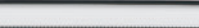

10. LED baterka

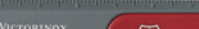

11. lupa



90519.TM transparentná modrá



90518.TR transparentná červená



90520.TC transparentná čierna



VICTORINOX

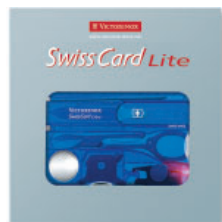

### SWISSCARD LITE

funkcie 1-4, 6, 8-11  
82 x 54 x 4 mm  
tampoprint

ks	1-9	10+	50+	150+
€	29,087	27,609	26,609	25,652



90548.TM transparentná modrá

### SWISSCARD QUATTRO

funkcie 1, 2, 4-9  
82 x 54 x 4 mm  
tampoprint

ks	1-14	15+	75+	225+
€	14,696	13,957	13,435	13,000



90547.TR transparentná červená



90549.TC transparentná čierna



90525.TR transparentná červená



90528.TM transparentná modrá



90530.TC transparentná čierna

### SWISSCARD CLASSIC

funkcie 1, 3-9  
82 x 54 x 4 mm  
tampoprint

ks	1-9	10+	50+	150+
€	22,957	21,783	21,000	20,261





novinka

**WORK USB**  
vreckový nôž s ôsmimi  
funkciami a odnímateľnou  
USB pamäťou  
(1, 5, 10-11, 13-14, 17-18)

58 x 18 x 17,5 mm



VICTORINOX



90554.TR (4 GB)

ks	1-9	10+	50+	150+
€	23,304	22,130	21,348	20,565

90560.TR (8 GB)

ks	1-9	10+	50+	150+
€	28,000	26,565	25,609	24,696



90503.C



90501.R



90502.M

**CLASSIC SD**  
originálny švajčiarsky nôž so  
siedmimi funkciami (1, 5, 10-14)

58 x 13 x 7 mm

ks	1-14	15+	75+	225+
€	12,913	12,261	11,783	11,391



**90531.R**  
**ECONOMY I**  
originálny švajčiarsky nôž  
s deviatimi funkciami  
(1, 3-4, 6-8, 10-12)

84 x 20 x 7 mm

ks	1-19	20+	100+	300+
€	11,087	10,522	10,174	9,783

90536.R

**ECONOMY II**  
originálny švajčiarsky nôž  
s desiatimi funkciami  
(1, 2, 4-8, 10-12)

84 x 20 x 10 mm

ks	1-14	15+	75+	225+
€	12,522	11,913	11,478	11,043



90511.R



**SPARTAN**  
originálny švajčiarsky nôž  
s dvanástimi funkciami (1-12)

91 x 20 x 13 mm

ks	1-9	10+	50+	150+
€	16,870	16,000	15,435	14,870

90512.M



90513.C



90515.TM



Funkcie nožov VICTORINOX:

1. klasická čepeľ
2. menšia čepeľ
3. vývrtka
4. otvárač na konzervy
5. skrutkovač s hranou 3 mm (tiež pre krížové skrutky)
6. otvárač na fľaše
7. skrutkovač s hranou 6 mm
8. odstraňovač izolácie drôtu
9. výstružník, priebojník
10. príveskový krúžok
11. pinzeta
12. špáradlo
13. nožnice
14. pilník na nechty
15. multifunkčný hák
16. pilka na drevo
17. guľičkové pero
18. USB flash disk



90551.R

**CLIMBER**  
originálny švajčiarsky nôž  
so štrnástimi funkciami (1-13, 15)

91 x 20 x 15 mm

ks	1-9	10+	50+	150+
€	25,826	24,522	23,609	22,783



90553.C



90552.TM



VICTORINOX



90598.TM

**HUNTSMAN**  
vreckový nôž s pätnástimi  
funkciami (1-13, 15, 16)

91 x 26 x 20 mm

ks	1-9	10+	50+	150+
€	29,087	27,609	26,609	25,652



90596.R



90597.TR

90541.R

**CAMPER**  
originálny švajčiarsky nôž  
s trinástimi funkciami (1-12, 16)

91 x 20 x 13 mm

ks	1-9	10+	50+	150+
€	19,739	18,739	18,043	17,391



90580.C

**FORESTER**  
originálny švajčiarsky nôž  
s dvanástimi funkciami  
(1, 3-12, 16)

111 x 30 x 17 mm

ks	1-4	5+	25+	75+
€	36,261	34,435	33,174	32,000



Všetky nože značky VICTORINOX sú vybavené kovovým emblémom (švajčiarskym krížom) na rukoväti noža. Každý nôž je balený samostatne v originálnej papierovej krabičke.



novinka

**90532.R**  
CHEESE  
vreckový nôž s nožom na syr  
a šiestimi funkciami (3, 10-12, 22, 32)

111 x 31,5 x 16 mm

ks	1-4	5+	25+	75+
€	33,739	32,043	30,870	29,783

**90579.R**  
NOMAD  
originálny švajčiarsky nôž  
s jedenástimi funkciami (1, 3-12)

111 x 30 x 15 mm

ks	1-9	10+	50+	150+
€	29,435	27,957	26,913	25,957



**90569.C**  
MILITARY  
originálny švajčiarsky nôž  
s dvanástimi funkciami  
(4-12, 16, 23, 30)

111 x 30 x 15 mm

ks	1-4	5+	25+	75+
€	36,609	34,783	33,478	32,304

**90571.C**  
NOMAD  
originálny švajčiarsky nôž  
s jedenástimi funkciami (1, 3-12)

111 x 30 x 15 mm

ks	1-9	10+	50+	150+
€	30,130	28,609	27,565	26,609



**90564.T**  
na nože  
s dĺžkou 58 mm



Darčeková krabička  
s priehľadným viečkom

114 x 47 x 25 mm  
tampoprint

ks	1-599	600+	3000+	9000+
€	0,326	0,309	0,300	0,287

novinka



**90565.T**  
na nože  
s dĺžkou 91 mm



Kožené puzdro  
na nože VICTORINOX  
tampoprint, razba, laserový popis

**90592.C**  
111 x 30 x 15 mm

ks	1-19	20+	100+	300+
€	9,304	8,826	8,522	8,217

pre nože dĺžky 111 mm  
do 3 vrstiev nástrojov

**90593.C**  
111 x 30 x 20 mm

ks	1-19	20+	100+	300+
€	10,739	10,217	9,826	9,478

pre nože dĺžky 111 mm  
do 6 vrstiev nástrojov

## Funkcie nožov VICTORINOX:

- klasická čepeľ
- vývrtka
- otvárač na konzervy
- skrutkovač s hranou 3 mm (tiež pre krížové skrutky)
- otvárač na fľaše
- skrutkovač s hranou 6 mm
- odstraňovač izolácie drôtu
- výstružník, priebojník
- príveskový krúžok
- pinzeta
- špáradlo
- nožnice
- multifunkčný hák
- pílka na drevo
- škrabák na kopytá
- tenké kliešte
- veľká čepeľ s vlnkovým ostrím 2/3 s poistkou
- veľká zubatá čepeľ s poistkou a očkom na rýchle otváranie
- hrot na rozbitie okna
- čepeľ na rezanie bezpečnostných pásov
- pílka na rezanie trištíveho skla
- luminiscenčná rúčka
- nylonové pútko
- kožené alebo nylonové puzdro
- Phillips krížový skrutkovač
- polovnícky nôž
- čepeľ na syr
- veľká čepeľ s očkom na rýchle otváranie
- pílka na drevo s očkom
- nylonová šnúčka
- klip na zavesenie
- skrutkovač 2 mm
- skrutkovač 3 mm
- nožnice na mäkký a tenký drôt až do 40 HRC
- otvárač krabic
- nôž s kombinovaným ostrím
- pilník na kov
- pílka na kov
- dláto a škrabka
- kliešte na izoláciu
- ohýbačka na drôt
- stahovačka drôtov/nožnice na izoláciu
- prípravok na vývrtku
- strihač tvrdých drôtov
- otvor na lanko
- desať jednotlivých pružín
- poistka





90570.Y

## RESCUE TOOL

originálny švajčiarsky záchranársky nôž  
s pätnástimi funkciami (6-12, 23-30)

111 x 30 x 20 mm

ks	1-4	5+	25+	75+
€	75,783	71,957	69,304	66,870

na rukováti je natlačený text Rescue Tool



90590.S

## SWISS TOOL SPIRIT

multifunkčné náradové kliešte – 27 funkcií  
v koženom puzdre s rotačným klipom  
(4, 6-9, 13, 15, 16, 21, 29, 30, 37-52)

105 x 35 x 14 mm

ks	1-4	5+	25+	75+
€	118,913	112,870	108,739	104,913



90509.Z

## HUNTER

originálny švajčiarsky lovecký nôž  
s dvanástimi funkciami (1, 3-6, 8-12, 16, 31)

111 x 30 x 15 mm

ks	1-4	5+	25+	75+
€	38,783	36,826	35,478	34,217

na rukováti je natlačený poľovnícky motív



VICTORINOX

90510.O

## HUNTER XT

originálny švajčiarsky lovecký nôž  
so šiestimi funkciami (3, 10, 31, 33-35)

novinka

111 x 34,5 x 20 mm

ks	1-4	5+	25+	75+
€	44,870	42,609	41,043	39,609



Doporučená potlač nožov VICTORINOX:



laserový popis alebo kalenie na čepel'



tampoprint



kovová intarzia

# PC doplnky, kalkulačky

USB kľúče s možnosťou dodania vybraných kapacít a farieb

od 1 ks



3217x.R

**USB pamäť Twister metal s hliníkovým metalickým závesom**  
cena na dopyt

76 x 20 x 10 mm  
tampoprint, laserový popis  
4 GB a 8 GB od 1 ks, ostatné kapacity od 100 ks

novinka



3219x.Z

3220x.E

3222x.B

novinka

**USB pamäť Twister transparent s hliníkovým závesom a transparentným telom**, cena na dopyt

76 x 20 x 10 mm  
tampoprint, laserový popis  
2 GB a 4 GB od 1 ks  
(ružová farba 3303x.TE len 2 GB od 1 ks),  
ostatné kapacity od 100 ks

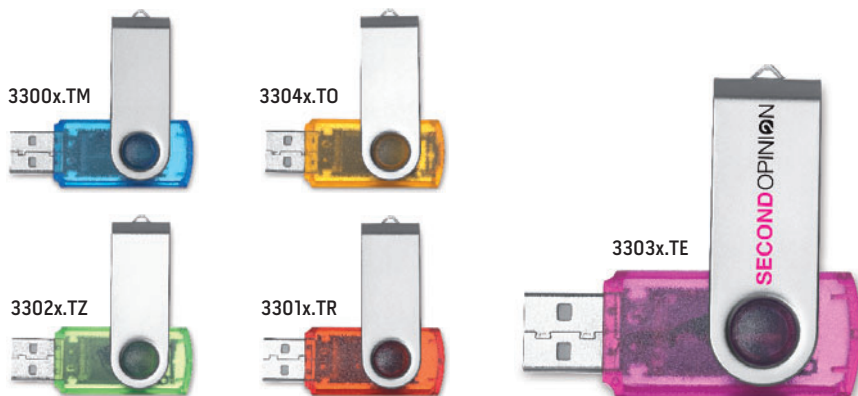

3300x.TM

3304x.TO

3302x.TZ

3301x.TR

3303x.TE



32977.Z

novinka

**MINI USB pamäť 4 GB Miniotator s hliníkovým metalickým závesom**  
cena na dopyt

32 x 14 x 6 mm  
tampoprint, laserový popis



32967.M

32987.R

32997.S



3256x.C

**USB pamäť Twister s hliníkovým závesom a prívieskom**, cena na dopyt

55 x 20 x 10 mm  
tampoprint, laserový popis  
1 GB-8 GB od 1 ks  
(červená farba 3270x.R len 2 a 4 GB od 1 ks),  
ostatné kapacity od 100 ks



3246x.M

3247x.B

3270x.R

Namiesto „x“ doplňte v kóde požadovanú kapacitu: 4=512 MB, 5=1 GB, 6=2 GB, 7=4 GB, 8=8 GB, 9=16 GB, 1=32 GB, 2=64 GB

Kompletný sortiment USB kľúčov, ich ceny a aktuálne kapacity zistíte najrýchlejšie na našich webových stránkach alebo na dopyt. USB kľúče majú rozhranie USB 2.0, pokiaľ nie je uvedené inak.



novinka

Hliníková USB pamäť 4 GB  
s vysúvacím konektorom  
cena na dopyt

60 x 23 x 13 mm  
tampoprint, laserový popis



33077.R

33087.S

33067.M

33057.C

32436.R

3244x.C



USB pamäť  
v kombinácii hliník/plast  
cena na dopyt

70 x 25 x 7 mm  
tampoprint, laserový popis  
modrá 32407.M – 4 GB,  
červená 32436.R – 2 GB,  
čierna 3244x.C – 2 GB a 4 GB,  
ostatné kapacity od 100 ks

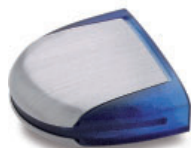

32407.M



3295x.S



Hliníková USB pamäť  
v tvare kľúča  
cena na dopyt

57 x 32 x 3 mm  
tampoprint, laserový popis  
2 GB a 4 GB od 1 ks,  
ostatné kapacity od 100 ks

3294x.R



3293x.C



3292x.M



3289x.S



32888.M



3291x.B

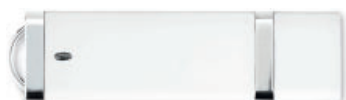

Plastová USB pamäť  
so závesným očkom  
cena na dopyt



72 x 20 x 7 mm  
tampoprint  
strieborná 3289x.S – 4 GB (2.0) a 8 GB (3.0)  
modrá 32888.M – 8 GB (3.0)  
biela 3291x.B – 2 GB a 4 GB  
čierna 3287x.C – 2 GB a 4 GB  
ostatné kapacity od 100 ks  
(8 GB pri položkách 32898.S a 32888.M má USB 3.0,  
ostatné kapacity majú štandardne 2.0)

3287x.C



novinka

33138.B

USB pamäť 8 GB  
v tvare kreditnej karty  
cena na dopyt

86 x 55 x 3 mm  
tampoprint



novinka

3314x.B

USB pamäť Bookmark v tvare  
záložky, cena na dopyt

52 x 28 x 15 mm  
tampoprint  
3314x.B: 1 GB, 2 GB a 4 GB od 1 ks,  
3315x.M: 2 GB a 4 GB od 1 ks,  
ostatné kapacity od 100 ks

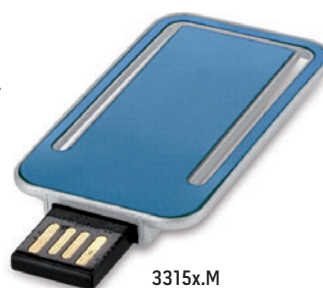

3315x.M

33127.B

33117.J

33107.Z

novinka

Green

USB pamäť 4 GB z kukuričného  
škrobu PLA, cena na dopyt

56 x 21 x 7 mm  
tampoprint

33097.M

novinka

3318x.S

USB pamäť Twister DeLuxe s hliníkovým  
závesom a prívieskom, cena na dopyt

65 x 15 x 18 mm  
tampoprint, laserový popis  
4 GB a 8 GB od 1 ks,  
ostatné kapacity od 100 ks



novinka

3317x.B

USB pamäť v tvare klipu  
cena na dopyt

60 x 18 x 13 mm  
tampoprint  
1 GB-8 GB od 1 ks,  
ostatné kapacity od 100 ks



novinka

Green

33167.P

USB pamäť 4 GB z bambusu  
cena na dopyt

55 x 25 x 10 mm  
tampoprint, laserový popis



3278x.S

Hliníkový USB flash disk  
Square so závesným očkom  
cena na dopyt

65 x 20 x 7 mm  
tampoprint, laserový popis  
2 GB a 4 GB od 1 ks,  
ostatné kapacity od 100 ks



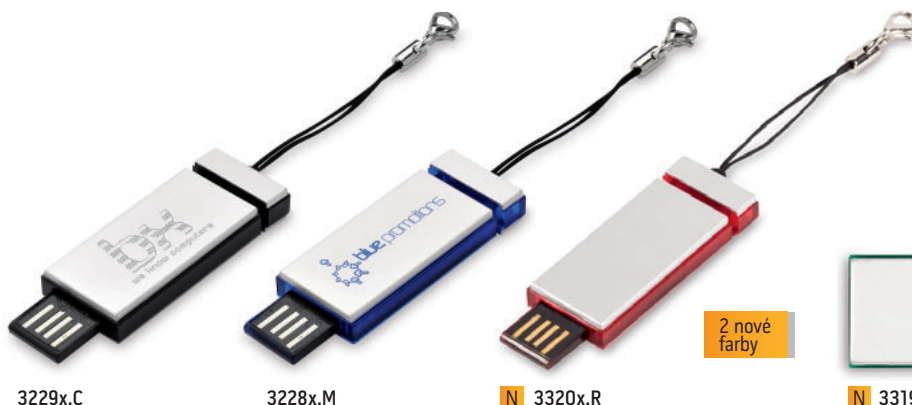

3229x.C

3228x.M

**N** 3320x.R

2 nové farby



**N** 3319x.Z

USB pamäť Slide s vysúvacím konektorom a šnúrkou s karabínkou hliník/plast, cena na dopyt

57 x 19 x 7 mm  
tampoprint, laserový popis  
1 GB a viac od 100 ks



2727x.C

Oválny USB flash disk Infocap s úškom, cena na dopyt

61 x 24 x 12 mm  
tampoprint  
1 GB a viac od 100 ks

Volne priložená čierna závesná šnúрка je súčasťou balenia USB flash disku.



2728x.M



2729x.R

3235x.S

Strieborná USB pamäť v tvare kreditnej karty  
cena na dopyt

86 x 55 x 3 mm  
tampoprint  
1 GB a viac od 100 ks



2737x.B

USB pamäť v tvare kreditnej karty s možnosťou plnofarebnou potlačou  
cena na dopyt

85 x 54 x 1 mm  
tampoprint  
1 GB a viac od 100 ks



2738x.B

USB pamäť v tvare malej kreditnej karty s možnosťou plnofarebnou potlačou  
cena na dopyt

60 x 30 x 3 mm  
tampoprint  
1 GB a viac od 100 ks



Namiesto „x“ doplňte v kóde požadovanú kapacitu:  
4=512 MB, 5=1 GB, 6=2 GB, 7=4 GB, 8=8 GB, 9=16 GB,  
1=32 GB, 2=64 GB

Kompletný sortiment USB kľúčov, ich ceny a aktuálne kapacity zistíte najrýchlejšie na našich webových stránkach alebo na dopyt. USB kľúče majú rozhranie USB 2.0, pokiaľ nie je uvedené inak.



Okrem štandardnej ponuky USB flash diskov vám ponúkame zákazkovú výrobu USB pamätí v 3D prevedení. Môžete si zvoliť tvar pamäte, spôsob stvárnenia loga, príslušenstvo k pamäti, darčekovú krabičku a pod. Zákazkovú výrobu ponúkame už od 100 ks v kapacitách od 1 GB do 64 GB. Pre bližšie informácie kontaktujte našich obchodníkov.

novinka



**Vysúvací USB kľúč Touchflash so stylusom a šnúrkou na mobil**  
cena na dopyt

68 x 19 x 8 mm  
tampoprint  
1 GB a viac od 100 ks



**USB flash disk Megabyte obdĺžnikového tvaru, hliník/plast**  
cena na dopyt

67 x 21 x 9 mm  
tampoprint, laserový popis  
1 GB a viac od 100 ks



Voľne priložená čierna závesná šnúrka je súčasťou balenia USB flash disku.

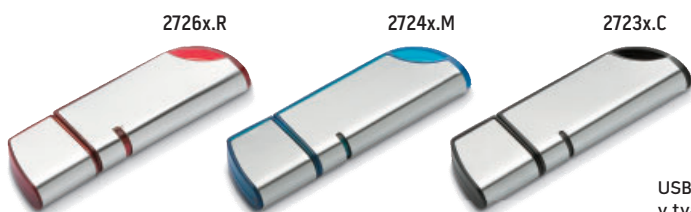

**USB flash disk Netlink v tvare zapalovača, hliník/plast, cena na dopyt**

68 x 20 x 9 mm  
tampoprint, laserový popis  
1 GB a viac od 100 ks

Voľne priložená čierna závesná šnúrka je súčasťou balenia USB flash disku.

N 3275x.O

2 nové farby

N 3276x.Y



**Rotáčna hliníková UBS pamäť Rotating**  
cena na dopyt

54 x 18 x 10 mm  
tampoprint, laserový popis  
1 GB a viac od 100 ks

Namiesto „x“ doplňte v kóde požadovanú kapacitu: 4=512 MB, 5=1 GB, 6=2 GB, 7=4 GB, 8=8 GB, 9=16 GB, 1=32 GB, 2=64 GB

Kompletný sortiment USB kľúčov, ich ceny a aktuálne kapacity zistíte najrýchlejšie na našich webových stránkach alebo na dopyt. USB kľúče majú rozhranie USB 2.0, pokiaľ nie je uvedené inak.



novinka

Kovový USB flash disk  
Magring v koženom obale  
s magnetickým uzáverom  
cena na dopyt

104 x 32 x 16 mm  
tampoprint, laserový popis  
1 GB a viac od 100 ks



2706x.C



2705x.H

Voľne priložená čierna závesná šnúrka  
je súčasťou balenia USB flash disku.



2703x.H

novinka

USB pamäť Turnwoodflash s dreveným  
telom a kovovým závesom  
cena na dopyt

55 x 19 x 10 mm  
tampoprint, laserový popis  
1 GB a viac od 100 ks



2704x.P

2701x.R



2702x.Z



2700x.M



USB pamäť Rotoflash  
s bielym telom  
a kovovým závesom  
cena na dopyt

novinka

56 x 19 x 12 mm  
tampoprint, laserový popis  
1 GB a viac od 100 ks



MARKSMAN

3279x.C

USB flash disk Blazer  
cena na dopyt

75 x 24 x 10 mm  
tampoprint  
1 GB a viac od 100 ks



2734x.R

2735x.O

2736x.Z



2733x.M

novinka

USB pamäť  
v silikónovom puzdre  
cena na dopyt

65 x 29 x 18 mm  
tampoprint  
1 GB a viac od 100 ks



16233.C

Flexibilná stolová lampa  
Illumination s 25timi LED diódami

Ø 110 x 370 mm  
tampoprint

ks	1-4	5+	25+	50+
€	35,061	32,898	31,714	30,980



Dotykový spínač na voľbu intenzity svetla,  
možnosť napájania cez USB kábel i zásuvku 230 V.

16121.S

LED lampička  
k PC alebo notebooku

Ø 10 x 453 mm  
tampoprint, laserový popis

ks	1-69	70+	350+	700+
€	2,690	2,527	2,437	2,380



novinka

20133.S

Guličkové pero s čiernou náplňou,  
LED svetlom a laserovým ukazovadlom

Ø 15 x 140 mm  
tampoprint

ks	1-99	100+	500+	1000+
€	1,826	1,761	1,696	1,657



20134.S

Multifunkčné pero 4v1  
v kovovom boxe

novinka



Ø 10 x 125 mm  
tampoprint, laserový popis

ks	1-49	50+	250+	500+
€	4,196	4,039	3,896	3,804

Guličkové pero, stylus, laserové  
ukazovadlo, LED svetlo

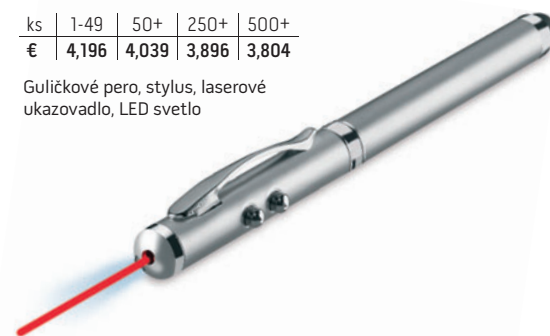

16124.C

Prívesok DUO s laserom  
a baterkou v kovovej krabičke

Ø 9 x 58 mm  
tampoprint, laserový popis

ks	1-59	60+	300+	600+
€	3,282	3,082	2,971	2,902



44304.B

Laserové ukazovadlo/  
baterka

87 x 26 x 6 mm  
tampoprint

ks	1-79	80+	400+	800+
€	2,574	2,374	2,204	2,061



**16128.Q**

USB optická myš PC Tracer ako auto  
s funkčnými kolesami a svetlami

117 x 60 x 38 mm  
tampoprint

ks	1-19	20+	100+	200+
€	8,939	8,408	8,082	7,918

**16237.C**

Minireproduktor Soundflash  
so slotom pre Mikro SD karty

73 x 45 x 54 mm  
tampoprint

ks	1-7	8+	40+	80+
€	23,429	22,000	21,224	20,694



Na pripojenie mobilného telefónu, iPodu,  
MP3 prehrávača či PC, slot pre Mikro SD karty.

**52321.C**

Podložka pod myš  
s vankúšikom

270 x 225 x 17 mm  
sieťotlač

ks	1-39	40+	200+	400+
€	4,957	4,783	4,609	4,522

**16085.G**

Extra plochá luxusná  
kalkulačka Numero

110 x 180 x 20 mm  
tampoprint, laserový popis

ks	1-14	15+	75+	150+
€	14,735	13,837	13,347	13,020

**44934.C**

Kalkulačka s blokom  
a mini guľičkovým perom

90 x 145 x 15 mm  
tampoprint

ks	1-59	60+	300+	600+
€	3,291	3,039	2,822	2,635

**16096.C**

12ciferná čierna kalkulačka  
Black Number

95 x 160 x 10 mm  
tampoprint

ks	1-39	40+	200+	400+
€	4,898	4,612	4,449	4,327



30812.P

Bambusová stolová solárna kalkulačka

76 x 136 x 10 mm  
tampoprint, laserový popis

ks	1-19	20+	100+	200+
€	12,261	11,826	11,391	11,130

52315.C

Kalkulačka v štýle iPod s farebnými tlačidlami

63 x 110 x 7 mm  
tampoprint

ks	1-89	90+	450+	900+
€	2,335	2,248	2,165	2,117



52348.M



Kalkulačka v kontrastných farbách

70 x 120 x 10 mm  
tampoprint

ks	1-69	70+	350+	700+
€	2,839	2,735	2,639	2,574



52350.C



52349.O



52325.O

Solárna kalkulačka zo silikónu

80 x 130 x 8 mm  
tampoprint

ks	1-79	80+	400+	800+
€	2,383	2,291	2,213	2,161



52322.M



52323.C



52324.Z

44972.M



44974.Y

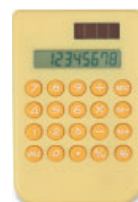

Solárna kalkulačka

65 x 100 x 8 mm  
tampoprint

ks	1-199	200+	1200+	2500+
€	0,861	0,796	0,739	0,691

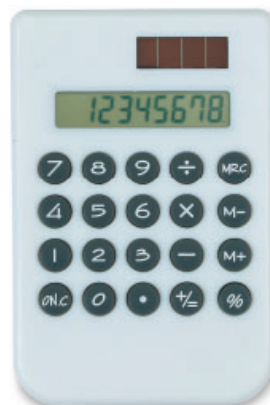

44971.B

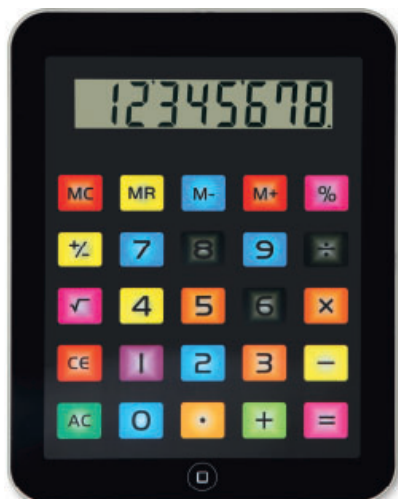

52340.C

Veľká kalkulačka  
s farebnými tlačidlami

190 x 240 x 6 mm  
tampoprint

ks	1-19	20+	100+	200+
€	9,087	8,739	8,435	8,261

44900.S

Multifunkčná kalkulačka

67 x 103 x 15 mm  
tampoprint

ks	1-99	100+	500+	1500+
€	2,013	1,861	1,726	1,613



44901.S



Multifunkčná kalkulačka

73 x 113 x 20 mm  
tampoprint

ks	1-99	100+	500+	1000+
€	2,461	2,274	2,152	2,083

44904.M



35444.S

Kalkulačka Magic

75 x 100 x 10 mm  
tampoprint

ks	1-199	200+	1200+	2500+
€	0,861	0,796	0,739	0,691



44991.S

Kalkulačka s konverznou  
tabuľkou a krytom

70 x 111 x 7 mm  
tampoprint

ks	1-99	100+	500+	1000+
€	1,735	1,600	1,487	1,387





# Meranie času a teploty

30376.S

Multifunkčná meteostanica

80 x 135 x 39 mm  
tampoprint

ks	1-19	20+	100+	200+
€	9,870	9,478	9,130	8,957



51034.Q

Meteostanica s hodinami Sol

85 x 165 x 20 mm  
tampoprint

ks	1-39	40+	200+	400+
€	6,217	6,000	5,783	5,652



51026.S

Meteostanica s modrým LCD displejom

58 x 100 x 50 mm  
tampoprint

ks	1-29	30+	150+	300+
€	6,870	6,609	6,348	6,217

20822.S

Digitálna meteostanica  
s kalendárom

130 x 130 x 20 mm  
tampoprint, laserový popis

ks	1-29	30+	150+	300+
€	7,261	7,000	6,739	6,565



51419.S

Digitálne hodiny

107 x 26 x 15 mm  
tampoprint

ks	1-99	100+	500+	1000+
€	1,861	1,791	1,726	1,687

42670.S

Digitálna meteostanica

60 x 136 x 24 mm  
tampoprint, laserový popis

ks	1-49	50+	200+	500+
€	3,804	3,513	3,261	3,043



42450.M

Multifunkčné hodiny  
s teplomerom

55 x 110 x 27 mm  
tampoprint

ks	1-99	100+	500+	1000+
€	2,139	1,974	1,830	1,709



**42661.S**  
Multifunkčná meteostanica  
s bezdrôtovým vonkajším čidlom

165 x 109 x 25 mm  
tampoprint

ks	1-9	10+	50+	100+
€	21,261	20,304	19,522	18,913



**20825.Q**

Digitálna meteostanica  
s podsvieteným  
panoramatickým displejom

245 x 88 x 50 mm  
tampoprint, laserový popis

ks	1-9	10+	50+	100+
€	20,174	19,435	18,739	18,304

novinka

hodiny, budík s funkciou snooze,  
kalendár, teplomer, vlhkomer



**42660.S**

Hodiny  
s meteorologickými údajmi

125 x 140 x 80 mm  
tampoprint, laserový popis

ks	1-19	20+	100+	200+
€	11,000	10,565	10,217	9,957



**20821.S**

Multifunkčná meteostanica  
s bezdrôtovým vonkajším  
čidlom, stolová aj nástenná

220 x 130 x 25 mm  
tampoprint, laserový popis

ks	1-9	10+	50+	100+
€	27,217	26,217	25,261	24,696



**80170.S**

Multifunkčná meteostanica  
s farebným displejom

80 x 140 x 39 mm  
tampoprint

ks	1-19	20+	100+	300+
€	9,522	9,130	8,739	8,522



hodiny, budík, teplomer, vlhkomer,  
pamäť 12 hodinového vývoja teploty



Green

20826.B

Stolové hodiny  
s LCD displejom  
na vodný pohon

novinka

106 x 104 x 91 mm  
tampoprint

ks	1-29	30+	150+	300+
€	8,000	7,696	7,435	7,261

Už žiadne batérie,  
stačí doliať iba vodu!



37100.S

Multifunkčný budík s teplomerom

70 x 60 x 60 mm  
tampoprint

ks	1-39	40+	200+	400+
€	4,870	4,696	4,522	4,435

43261.M

Cestovný multifunkčný budík

60 x 80 x 28 mm  
tampoprint

ks	1-99	100+	500+	1000+
€	1,287	1,187	1,104	1,030



43251.C

43252.M



43254.Z

Multifunkčné hodiny  
s teplomerom

114 x 108 x 66 mm  
tampoprint

ks	1-59	60+	300+	600+
€	3,470	3,200	2,974	2,774

43253.0



51418.S

Stolové digitálne hodiny s tromi  
fotorámčkami a klipom na poznámky

60 x 110 x 40 mm  
tampoprint

ks	1-39	40+	200+	400+
€	4,739	4,565	4,391	4,304

51361.S

Digitálny teplomer s prísavkou

30 x 64 x 20 mm  
tampoprint

ks	1-89	90+	450+	900+
€	2,252	2,170	2,091	2,043





terč s odpočítavanim, palebný tón pištole,  
záznam vlastného hlasu



Zastrel si svoj budík!

16170.B

Unikátny digitálny budík  
Western s pištoľou a terčom

139 x 145 x 43 mm  
tampoprint

ks	1-4	5+	25+	50+
€	31,306	29,388	28,327	27,673



37101.S

Cestovný kovový budík

67 x 67 x 20 mm  
tampoprint, laserový popis

ks	1-29	30+	150+	300+
€	6,913	6,652	6,435	6,261



51420.B

Stolové i nástenné hodiny s tromi  
fotorámčekomí a dvomi magnetmi

220 x 300 x 6 mm  
tampoprint, laserový popis

ks	1-14	15+	75+	150+
€	11,826	11,391	11,000	10,739



51367.C

51368.M



30380.M

Budík Flexi – držiak  
odkazov, pier, mobilov,...

70 x 100 x 40 mm  
tampoprint

ks	1-69	70+	350+	700+
€	3,087	2,974	2,865	2,800

Stolové hodiny  
s rámčekom na fotografie  
a poznámkovou tabuľou

150 x 90 x 10 mm  
tampoprint

ks	1-49	50+	250+	500+
€	3,917	3,770	3,635	3,552



2 magnety sú súčasťou balenia



**16187.S**

Otočné hodiny so svetovými časmi na sklenenom podstavci

novinka

60 x 96 x 60 mm  
tampoprint, laserový popis, pieskovanie

ks	1-4	5+	25+	50+
€	35,347	33,184	32,000	31,265

**51020.V**

Hodiny s teplomerom a vlhkomerom

78 x 257 x 70 mm  
tampoprint, laserový popis

ks	1-14	15+	75+	150+
€	11,348	10,913	10,565	10,304



**80172.V**

Drevené hodiny s teplomerom a vlhkomerom

185 x 85 x 35 mm  
tampoprint, laserový popis

ks	1-19	20+	100+	300+
€	9,304	8,957	8,565	8,348



**16172.C**

Hodiny s budíkom, teplomerom a vlhkomerom

275 x 115 x 34 mm  
tampoprint, laserový popis

ks	1-9	10+	50+	100+
€	18,082	16,980	16,367	16,000



**28060.K**

Rotujúce hodiny v sklenenom zväčšujúcom glóbose

92 x 108 x 97 mm  
tampoprint, laserový popis

ks	1-4	5+	25+	50+
€	36,739	35,391	34,130	33,348

**42952.S**

Stolové hodiny v kombinácii kovu s čiernym drevom

70 x 96 x 17 mm  
tampoprint, laserový popis

ks	1-39	40+	200+	500+
€	5,478	5,043	4,696	4,391







30386.P

Solárne hodiny  
z bambusového dreva

novinka

86 x 86 x 15 mm  
tampoprint, laserový popis

ks	1-19	20+	100+	200+
€	11,087	10,696	10,304	10,043

hodiny, budík s funkciou snooze, kalendár, teplomer,  
prepínanie 12/24 hod, nočné podsvietenie

novinka

80178.P

Presýpacie hodiny  
v drevenom rámeØ 78 x 123 mm  
tampoprint, laserový popis

ks	1-24	25+	125+	250+
€	7,609	7,304	7,043	6,826

presypanie piesku v intervale 5 minút



51403.S

Drevené hodiny  
s teplomerom a vlhkomerom170 x 85 x 25 mm  
tampoprint, laserový popis

ks	1-9	10+	50+	100+
€	25,478	24,522	23,652	23,087

16180.S

Kruhové variabilné kovové  
hodiny s magnetom

novinka

Ø 50 mm (jednotlivé plochy)  
tampoprint, laserový popis

ks	1-7	8+	40+	80+
€	27,469	25,796	24,857	24,286

hodiny, fotorámik,  
plocha pre logo

28069.Q

Hodiny Monza

108 x 135 x 115 mm  
tampoprint, laserový popis

ks	1-4	5+	25+	50+
€	39,783	38,304	36,913	36,043



28064.S

Skladacie kovové stolové hodiny

Ø 60 x 30 mm  
tampoprint, laserový popis

ks	1-9	10+	50+	100+
€	27,957	26,913	25,957	25,348





**30374.C**

Športové hodinky SLAZENGER

Ø 47 x 220 mm  
laserový popis

ks	1-4	5+	25+	50+
€	35,783	34,478	33,217	32,435



**43201.C**

Darčeková sada dámskych a pánskych kovových hodínok s dátumovkou

90 x 90 x 65 mm  
tampoprint, laserový popis

ks	1-14	15+	60+	150+
€	17,348	16,217	15,217	14,304

**80180.B**



Náramkové hodinky so silikónovým pásičkom v darčekovej krabičke

Ø 44 x 240 x 14 mm  
tampoprint (na krabičku)

ks	1-19	20+	100+	300+
€	9,435	9,043	8,696	8,478

Náramkové hodinky s quartzovým strojčekom a priehľadným remienkom

Ø 30 x 230 x 10 mm  
laserový popis

ks	1-39	40+	200+	400+
€	5,522	5,348	5,130	5,000

**20294.O**



**20291.M**



**20292.R**



**20293.C**

**80181.R**



**80182.M**



**43202.S**

Celokovové náramkové hodinky

90 x 90 x 65 mm  
tampoprint, laserový popis

ks	1-39	40+	200+	500+
€	5,478	5,043	4,696	4,391





## VICTORINOX Garrison

Luxusné švajčiarske hodinky so strojčekom Quartz a puzdrom z nerezovej ocele (316L) sú vodotesné až do hĺbky 100m. Majú nárazuvzdorné sklíčko z minerálneho kryštálu, luminiscenčné ručičky a prvky ciferníka, dátumovku, korunku s rýchlym nastavenním dátumu. Logo je možné vylaserovať na spodnej časti hodiniek.

Náramkové hodinky VICTORINOX Garrison s kovovým náramkom z nerezovej ocele

ks	1-3	4+	20+	40+
€	127,435	121,000	116,565	112,435



90533.S  
pánske  
Ø 40 mm

Náramkové hodinky  
VICTORINOX Garrison

ks	1-4	5+	25+	50+
€	103,130	97,913	94,304	91,000



90534.S  
dámske  
Ø 34 mm



90535.S  
pánske  
Ø 40 mm



90537.S  
dámske  
Ø 34 mm



VICTORINOX

novinka



90538.S  
pánske  
Ø 40 mm

Náramkové hodinky  
VICTORINOX Garrison Elegance  
s koženým náramkom

ks	1-3	4+	20+	40+
€	119,435	113,391	109,261	105,391



90539.S  
dámske  
Ø 32 mm

Náramkové hodinky VICTORINOX  
Garrison Elegance s kovovým  
náramkom z nerezovej ocele

ks	1-2	3+	15+	30+
€	165,000	156,913	151,174	145,870



90542.G  
pánske  
Ø 40 mm



90543.G  
dámske  
Ø 32 mm



**Slazenger**

30375.C

Chronografické hodinky  
SLAZENGER

Ø 40 mm  
tampoprint, laserový popis

ks	1-4	5+	25+	50+
€	95,087	91,565	88,261	86,217





16178.S

Nástenné hodiny Punkto

Ø 351 mm  
tampoprint (rám/kryt ciferníka)

ks	1-19	20+	100+	200+
€	8,816	8,245	7,959	7,755

42471.M

Nástenné hodiny

Ø 237 mm  
tampoprint (rám)

ks	1-99	100+	500+	1000+
€	2,126	1,961	1,822	1,700



51003.B



51004.M

Nástenné hodiny

Ø 230 mm  
tampoprint

ks	1-29	30+	150+	300+
€	7,130	6,870	6,609	6,478

tlač možná i na ciferník

42403.M



Nástenné hodiny

Ø 245 mm  
sietotlač, ofset

ks	1-49	50+	250+	500+
€	4,739	4,478	4,217	4,043

- tlač na ciferník
- vlastný motív ciferníka vám vykalkulujeme na požiadanie

42401.C

42402.B





16107.C

Elegantné nástenné hodiny Hemera

Ø 310 mm  
tampoprint (kryt ciferníka)

ks	1-19	20+	100+	200+
€	9,388	8,816	8,490	8,286



vonkajší snímač

16182.S

novinka

Nástenné hodiny s kovovým rámom  
a bezdrôtovým vonkajším čidlom

Ø 300 mm x 40 mm  
tampoprint (plastový kryt ciferníka),  
laserový popis (rám)

ks	1-7	8+	40+	80+
€	29,469	27,633	26,653	26,041

digitálny ukazovateľ vnútornej  
a vonkajšej teploty



42461.S

Kovové nástenné hodiny

Ø 250 mm  
tampoprint, laserový popis

ks	1-29	30+	150+	400+
€	6,391	5,870	5,478	5,087



42430.C

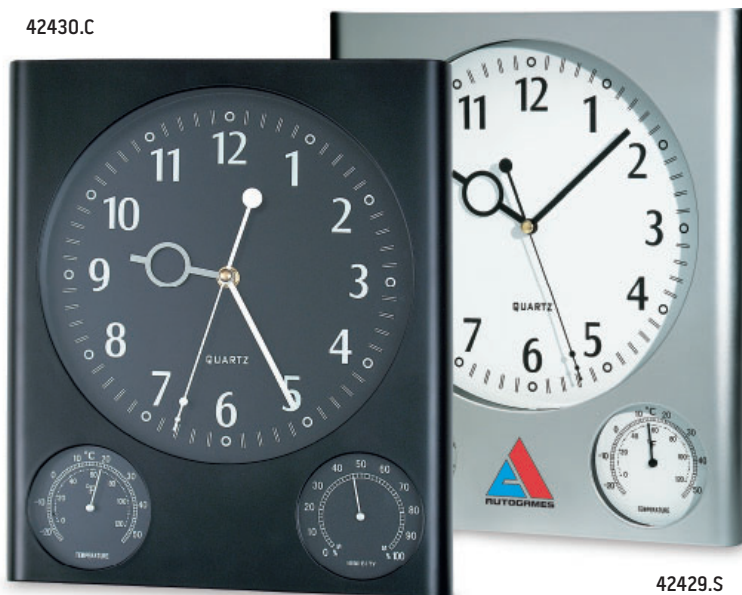

42429.S

Hodiny s teplomerom a vlhkomerom

270 x 320 x 20 mm  
tampoprint

ks	1-29	30+	150+	300+
€	6,478	6,217	5,870	5,609



# Baterky, náradie, hobby

Plastová batéria s pútkom  
a výklopnou hlavou

novinka

35 x 85 x 20 mm  
tampoprint

ks	1-299	300+	1500+	3000+
€	0,757	0,722	0,696	0,678

dodávaná vrátane batérie



42857.M



42855.S

9x LED hliníková baterka

Ø 26 x 90 mm  
tampoprint, laserový popis

ks	1-149	150+	600+	1500+
€	1,630	1,543	1,474	1,439



42856.C



42853.K



9x LED kovová baterka

Ø 30 x 100 mm  
tampoprint, transfer, laserový popis

ks	1-39	40+	200+	500+
€	5,478	5,043	4,696	4,391



42852.S



42854.M



20440.S

3 x LED baterka s dynamom  
i solárnym dobíjaním50 x 90 x 34 mm  
tampoprint

ks	1-49	50+	250+	500+
€	4,391	4,243	4,091	3,996



37311.C

DUNLOP 2x LED baterka s dynamom  
a dobijateľnou batériou110 x 55 x 25 mm  
tampoprint

ks	1-29	30+	150+	300+
€	8,609	8,304	8,000	7,826



50321.M

5x LED baterka s dynamom  
a jednorázovou batériouØ 50 x 100 mm  
tampoprint

ks	1-59	60+	300+	600+
€	3,230	3,109	3,000	2,930



34428.S

3xLED baterka s dynamom

155 x 60 x 50 mm  
tampoprint

ks	1-39	40+	200+	400+
€	5,565	5,348	5,174	5,043

2x LED baterka s dynamom  
a jednorázovou batériou100 x 50 x 25 mm  
tampoprint

ks	1-99	100+	500+	1000+
€	1,696	1,635	1,578	1,539



30217.S



30218.M



30219.O



30220.C



30215.B



30216.R

možnosť predĺženia až na dĺžku 555 mm



nová farba  
16230.C

Teleskopická 3x LED baterka Reflect s ohybným koncom  
Ø 20 x 168 mm (zložená)  
tampoprint, laserový popis

ks	1-19	20+	100+	200+
€	9,020	8,490	8,163	8,000

16238.M



dodávaná vrátane šnúrky

37310.C  
9x LED kovová baterka DUNLOP v boxe  
Ø 25 x 110 mm  
tampoprint, laserový popis

novinka

ks	1-19	20+	100+	200+
€	11,087	10,696	10,304	10,043



42890.S  
Kovová baterka  
180 x 68 x 32 mm (box)  
tampoprint, laserový popis

ks	1-49	50+	250+	750+
€	3,896	3,596	3,339	3,113



42849.S  
Baterka s 9 LED diódami v boxe, vrátane batérii  
125 x 80 x 40 mm (box)  
Ø 33 mm x 100 mm (baterka)  
tampoprint, laserový popis

ks	1-39	40+	150+	400+
€	5,870	5,435	5,043	4,696



42880.S  
Kovová baterka – prívesok v boxe  
105 x 105 x 22 mm (box)  
Ø 20 x 85 mm (baterka)  
tampoprint, laserový popis

ks	1-99	100+	500+	1500+
€	2,170	2,022	1,926	1,813



novinka

50668.Q  
Tužková batéria AA (UM3)  
ks 1-899 | 900+ | 4500+ | 9000+  
€ 0,213 | 0,204 | 0,196 | 0,191



novinka

50669.Q  
Mikrotužková batéria AAA (UM4)  
ks 1-799 | 800+ | 4000+ | 8000+  
€ 0,230 | 0,222 | 0,213 | 0,209





16092.C

Baterka s 5x LED slúži  
na pripevnenie k čiapke83 x 55 x 25 mm  
tampoprint

ks	1-79	80+	400+	800+
€	2,473	2,318	2,237	2,184



16093.C

Baterka na čelo Kilimandžáro,  
12x LEDØ 40 mm (baterka)  
tampoprint

ks	1-39	40+	200+	400+
€	4,571	4,286	4,122	4,041



34439.R

Blikajúca odrazka s klipom

Ø 52 x 20 mm  
tampoprint

ks	1-199	200+	1000+	2000+
€	0,839	0,809	0,778	0,761



16091.Q

Intervalová baterka  
na čelo s 5x LED45 x 40 x 18 mm  
tampoprint

ks	1-59	60+	300+	600+
€	3,327	3,122	3,008	2,939



30125.Y

Bezpečnostná blikajúca s reflexnou  
páskou na ruku SLAZENGER280 x 25 mm (páska)  
38 x 47 x 17 mm (blikajúca)  
tampoprint

ks	1-79	80+	400+	800+
€	2,448	2,357	2,274	2,222



30127.Y

Bezpečnostná páska Slap Wrap

340 x 30 mm  
tampoprint

ks	1-89	90+	450+	900+
€	2,161	2,083	2,004	1,961



možnosť predĺženia až na dĺžku 1180 mm



16239.S

Teleskopická škrabka Arctic s metličkou

900 x 115 mm  
tampoprint

ks	1-29	30+	150+	300+
€	8,367	7,878	7,592	7,388

20441.M



20442.R

Škrabka s rukavicou s umelým kožuškom

170 x 245 mm (rukavica)  
transfer

ks	1-119	120+	600+	1200+
€	1,696	1,635	1,578	1,539

91003.M



91005.C

91004.R

91002.Y

91001.B

Škrabka na ľad

97 x 175 x 19 mm  
tampoprint

ks	1-599	600+	3000+	6000+
€	0,396	0,378	0,365	0,352

46038.Y



46039.R

46037.B

Škrabka/stierka

100 x 100 x 3 mm  
tampoprint

ks	1-299	300+	1000+	2500+
€	0,513	0,478	0,457	0,439



49120.B

Škrabka/stierka s rukoväťou

110 x 175 x 8 mm  
tampoprint

ks	1-599	600+	3000+	6000+
€	0,430	0,387	0,374	0,365

ks	1-499	500+	2000+	4000+
€	0,300	0,287	0,278	0,265

Škrabka na ľad

120 x 105 x 2 mm  
tampoprint

46032.R

46034.Y



46031.B



46033.M

46035.Z



44996.B

Digitálny alkoholtester s LCD hodinami

37 x 100 x 17 mm  
tampoprint

ks	1-19	20+	100+	300+
€	11,696	10,783	10,043	9,348

orientačné meranie  
hladiny alkoholu v dychu

34464.C

Autovysávač  
s adaptérom na 12 V

novinka

190 x 90 x 85 mm  
tampoprint

ks	1-19	20+	100+	200+
€	12,304	11,870	11,435	11,174



20207.C

Pumpa 12 V, so sadou  
koncoviek pre auto i bicykel120 x 140 x 52 mm  
tampoprint

ks	1-9	10+	50+	100+
€	23,304	22,435	21,652	21,130



34463.S

Kovový merač tlaku v pneumatikách

Ø 10 x 90 mm  
tampoprint, laserový popis

ks	1-299	300+	1500+	3000+
€	0,726	0,700	0,674	0,661



52369.B

Digitálny alkoholtester

36 x 95 x 18 mm  
tampoprint

ks	1-19	20+	100+	200+
€	10,957	10,565	10,174	9,957



34461.C

Alkoholtester  
s farebnými diódami40 x 80 x 15 mm  
tampoprint

ks	1-19	20+	100+	200+
€	9,870	9,478	9,130	8,957



20204.C

Digitálny merač tlaku  
kombinovaný s baterkou, 2x LED32 x 140 x 32 mm  
tampoprint

ks	1-19	20+	100+	200+
€	10,478	10,087	9,739	9,522





90566.C

Cyklistické náradie  
VICTORINOX

novinka



100 x 35 x 20 mm  
tampoprint

ks	1-9	10+	50+	150+
€	28,652	27,609	26,826	26,000



30214.C

Taštička na bicykel

350 x 230 x 200 mm  
polyester 6000  
sietotlač, transfer

ks	1-39	40+	200+	400+
€	4,913	4,739	4,565	4,478



Bezpečnostná reflexná vesta

650 x 650 mm, univerzálna veľkosť XL  
100% polyester  
sietotlač, transfer

ks	1-59	60+	300+	600+
€	3,683	3,548	3,417	3,339

spĺňa EN471



37318.0

37317.Y

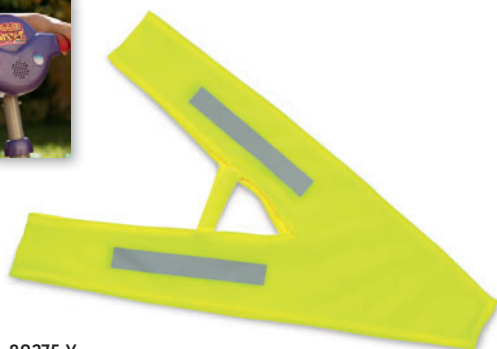

80275.Y

Detská reflexná vesta

novinka

260 x 420 mm  
sietotlač, transfer

ks	1-79	80+	400+	800+
€	2,478	2,348	2,248	2,191

20187.Y

Detská bezpečnostná vesta

450 x 400 mm  
100% polyester  
sietotlač, transfer

ks	1-79	80+	400+	800+
€	2,430	2,343	2,257	2,204

spĺňa EN471 Trieda 2





34082.M

Servisné náradie na opravu bicykla

90 x 120 x 45 mm  
sietotlač, transfer

ks	1-29	30+	150+	300+
€	8,043	7,739	7,435	7,261



42549.D

Multifunkčné  
kliešte s náradím65 x 145 x 30 mm  
tampoprint, laserový popis, sietotlač, transfer

ks	1-19	20+	100+	300+
€	10,739	9,913	9,217	8,609

34436.M

Multifunkčné kliešte s náradím

41 x 100 x 20 mm  
tampoprint, laserový popis, sietotlač, transfer

ks	1-19	20+	100+	200+
€	10,435	10,043	9,696	9,478



30212.S

Sada náradia – 25 dielov  
v nylónovom puzdre160 x 160 x 40 mm (zatvorené)  
sietotlač, transfer

ks	1-19	20+	100+	200+
€	10,478	10,087	9,739	9,522



42847.Z

Multifunkčné záhradnícke  
nožnice v sade140 x 140 x 25 mm  
transfer, tampoprint, laserový popis

ks	1-99	100+	300+	1000+
€	3,022	2,883	2,674	2,578





42846.S

Sada náradia – 22 dielov

118 x 100 x 33 mm  
tampoprint, sietotlač

ks	1-49	50+	200+	600+
€	4,248	4,065	3,796	3,617



50217.Q

Sada náradia - 25 dielov

155 x 100 x 25 mm  
tampoprint

ks	1-29	30+	150+	300+
€	7,478	7,217	6,957	6,783



16229.C

Ultrazvukový merač vzdialenosti Quantum

novinka

Ø 50 x 134 mm  
tampoprint

ks	1-9	10+	50+	100+
€	19,306	18,122	17,469	17,061



Meria vzdialenosti v rozsahu cca 0,5 až 13 m, dodávaný vrátane 9V batérie. Okamžitý výpočet m<sup>2</sup> alebo m<sup>3</sup>, prípadne súčtu meraných vzdialeností.

91020.B



91021.Y



91022.P



Drevený skladací meter, 1m

novinka

240 x 15 x 17 mm  
tampoprint, sietotlač

ks	1-149	150+	750+	1,500+
€	1,296	1,243	1,196	1,152



KVALITNÝ  
ČESKÝ  
VÝROBOK

certifikácia presnosti EG III  
obojsstranná stupnica v mm  
viacvrstvá povrchová úprava, vrchná vrstva UV lak

91025.B



91026.Y



91027.P



Drevený skladací meter, 2m

novinka

240 x 15 x 33 mm  
tampoprint, sietotlač

ks	1-79	80+	400+	800+
€	2,396	2,300	2,213	2,135



**90231.Q**  
**BOSCH 65-dielna sada pre domáчих majstrov X-line**  
 255 x 230 x 65 mm  
 sieťotlač

ks	1-4	5+	15+	30+
€	43,391	41,652	40,087	38,609

**90235.Q**  
**BOSCH 10-dielna vrecková sada skrutkovacích bitov**

120 x 70 x 45 mm  
 tampoprint

ks	1-14	15+	40+	100+
€	15,087	14,478	13,913	13,435



**BOSCH**



**90236.Q**  
**BOSCH 9-dielna sada skrutkovacích bitov s magnetickým držiakom**

120 x 70 x 45 mm  
 tampoprint

ks	1-14	15+	40+	100+
€	13,000	12,609	12,130	11,696



**37316.C**  
**Sada náradia DUNLOP do auta so štartovacími káblami a pneumeráčom**

300 x 345 x 90 mm  
 sieťotlač, laserový popis

ks	1-4	5+	25+	50+
€	79,000	76,087	73,348	71,652



štartovacie káble, hasák, dlhý pilník, páska, kefa, rezač, pneumeráč, držiak skrutkovačov s 3 adaptérmi, 10 bitov v držiaku, 9 hlavíc v držiaku a maticový kľúč, box z EVA materiálu



**37315.Y**  
**DUNLOP sada náradia v kufri, 199 dielov**

350 x 270 x 80 mm  
 sieťotlač

ks	1-4	5+	25+	50+
€	68,087	65,565	63,261	61,783





16241.M



Samonavijací meter s karabínou, 2 m

Ø 47 x 66 x 18 mm  
tampoprint

ks	1-99	100+	500+	1000+
€	1,751	1,641	1,584	1,547

16242.C



16243.R



Samonavijací meter s karabínou, 1,7 m

85 x 47 x 10 mm  
tampoprint

ks	1-199	200+	1000+	2000+
€	0,896	0,865	0,835	0,813

52174.TO



42605.C



Samonavijací meter, 2 m

62 x 55 x 20 mm  
tampoprint, laserový popis

ks	1-299	300+	1500+	3000+
€	0,861	0,796	0,743	0,709

42602.M



42604.Y

42603.R

52173.TR



52171.TM

42611.R



42614.B



Samonavijací meter s priveskom, 1 m

40 x 40 x 10 mm  
tampoprint

ks	1-499	500+	2500+	5000+
€	0,426	0,404	0,387	0,378

42610.M



42612.Y



42615.B

Samonavijací meter, 1 m

50 x 37 x 10 mm  
tampoprint

ks	1-499	500+	2500+	5000+
€	0,474	0,452	0,430	0,422



30223.B

Krajčířský meter, 1,5 m

Ø 50 mm  
tampoprint

ks	1-399	400+	2000+	4000+
€	0,487	0,465	0,452	0,439







37321.C

DUNLOP samonavijací  
meter s brzdou, 3 m

novinka

85 x 70 x 40 mm  
tampoprint

ks	1-39	40+	200+	400+
€	5,478	5,304	5,087	5,000



37320.Y

DUNLOP samonavijací meter  
s brzdou a prívieskom, 1 m

novinka

41 x 36 x 13 mm  
tampoprint

ks	1-199	200+	1000+	2000+
€	0,926	0,891	0,861	0,839

logo je na metre vytlačené

50300.B

50304.Y

Nôž s odlamovacou  
čepeľou135 x 14 x 8 mm  
tampoprint

ks	1-999	1000+	4000+	8000+
€	0,170	0,157	0,143	0,135



50335.B

Nôž s odlamovacou  
čepeľou155 x 30 x 10 mm  
tampoprint

ks	1-599	600+	3000+	6000+
€	0,278	0,257	0,239	0,222



34431.C

Samonavijací meter  
s klipom na opasok, 3 m60 x 59 x 35 mm  
tampoprint

ks	1-99	100+	500+	1000+
€	1,543	1,487	1,435	1,400



34430.C

Samonavijací meter  
s klipom na opasok, 5 m70 x 70 x 40 mm  
tampoprint

ks	1-79	80+	400+	800+
€	2,448	2,357	2,274	2,222

ks	1-199	200+	1000+	2000+
€	0,996	0,926	0,852	0,796

42606.C

Samonavijací meter, 3 m

70 x 63 x 20 mm  
tampoprint, laserový popis

42607.C

Samonavijací meter, 5 m

76 x 67 x 25 mm  
tampoprint, laserový popis

ks	1-149	150+	750+	1500+
€	1,565	1,448	1,343	1,252



# Darčeky pre deti

51285.R



51284.M



Plyšový medvedík s nohavicami

160 x 145 x 125 mm  
transfer

ks	1-59	60+	300+	600+
€	3,413	3,283	3,165	3,096

Medvedík v tričku ako privesok

145 x 60 x 45 mm  
transfer

ks	1-129	130+	650+	1300+
€	1,500	1,448	1,396	1,361



Lietadlo s gumičkou z EVA materiálu ako 3D puzzle

127 x 40 x 150 mm

ks	1-499	500+	2500+	5000+
€	0,413	0,396	0,378	0,370



80232.R



80233.M



80231.Y

51282.Y

51280.M



51283.Z

51281.R

Loptička z PVC s výplňou

Ø 51 mm  
tampoprint

ks	1-399	400+	2000+	4000+
€	0,457	0,439	0,422	0,413

51260.R

Antistresová loptička z mäkkého polyuretánu

Ø 65 mm  
tampoprint

ks	1-299	300+	1500+	3000+
€	0,570	0,548	0,530	0,517

35028.B

Futbalová antistresová loptička

Ø 70 mm  
tampoprint

ks	1-299	300+	1500+	3000+
€	0,726	0,700	0,674	0,661



51266.B

51268.Z



51269.O

51267.Y

51265.M



novinka

80265.Y



80266.R



80267.M



## Ohybné plastové pravítko 30cm

305 x 30 mm  
tampoprint, sieťotlač

ks	1-399	400+	2000+	4000+
€	0,530	0,509	0,487	0,474



20319.M



20320.Z

## Keramická pokladnička

96 x 83 x 80 mm  
tampoprint

ks	1-79	80+	400+	800+
€	2,561	2,465	2,378	2,322



50172.X

## Hlavolam v kocke (mix)

40 x 40 x 40 mm  
tampoprint

ks	1-599	600+	3000+	6000+
€	0,313	0,300	0,287	0,283

50334.B

## Hlavolam Pätnástka

75 x 90 x 5 mm  
tampoprint

ks	1-399	400+	2000+	4000+
€	0,491	0,470	0,457	0,443



46003.R



46002.Y



## Plastové jo-jo

Ø 50 mm  
tampoprint

ks	1-499	500+	2500+	5000+
€	0,383	0,357	0,339	0,326



46005.Z



46001.B



46004.M



51276.R

51277.B

51279.O

## Klasická plastová píšťalka na šnúrke

50 x 24 x 19 mm  
tampoprint

ks	1-699	700+	3500+	7000+
€	0,261	0,252	0,243	0,235

51275.M





**80227.P**  
Sada 6 voskoviek

50 x 90 x 9 mm  
tampoprint

ks	1-699	700+	3500+	7000+
€	0,278	0,265	0,257	0,248



**80228.P**  
Sada 12 voskoviek

100 x 90 x 9 mm  
tampoprint

ks	1-399	400+	2000+	4000+
€	0,543	0,522	0,500	0,487

**51250.P**  
Drevené jo-jo

Ø 55 mm  
tampoprint, laserový popis

ks	1-399	400+	2000+	4000+
€	0,491	0,470	0,457	0,443



ks	1-999	1000+	5000+	10 000+
€	0,213	0,204	0,196	0,187

**41807.P**  
Sada 6 pasteliek

45 x 90 x 7 mm  
tampoprint



**20006.P**  
Sada 12 pasteliek

90 x 90 x 7 mm  
tampoprint

ks	1-499	500+	2500+	5000+
€	0,426	0,391	0,365	0,339



51259.0

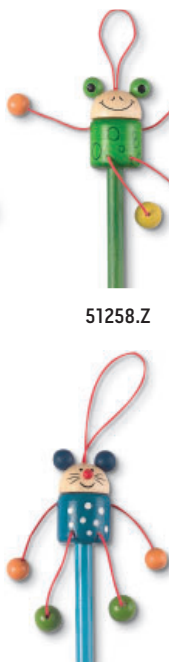

51258.Z

51255.M



51256.R

51257.Y

Ceruzka so zábavnou figúrkou

Ø 7 x 170 mm  
tampoprint

ks	1-499	500+	2500+	5000+
€	0,409	0,391	0,378	0,370

51312.R



51314.Y



51313.B



51315.O



51311.M



Guličkové pero  
na šnúrke s bublifukom

35 x 160 mm  
tampoprint

ks	1-499	500+	2500+	5000+
€	0,409	0,391	0,378	0,370



35027.P

Hlavolam – kocka

40 x 40 x 40 mm  
sietotlač, transfer (na sáčok)

ks	1-199	200+	1000+	2000+
€	1,074	1,035	1,000	0,974



30329.P

Sada 3 drevených hlavolamov

180 x 66 x 77 mm  
tampoprint, laserový popis

ks	1-29	30+	150+	300+
€	7,043	6,783	6,565	6,391



80268.Y

Reflexný príviesok na kľúče - smajlík

Ø 70 mm  
tampoprint

ks	1-499	500+	2500+	5000+
€	0,426	0,409	0,391	0,383

novinka



80276.Y

Reflexná samolepka - smajlík

Ø 70 mm  
tampoprint

ks	1-799	800+	4000+	8000+
€	0,230	0,222	0,213	0,209

novinka

80269.Y

Reflexný príviesok na kľúče -  
vesta s karabínou45 x 56 mm  
tampoprint

ks	1-499	500+	2500+	5000+
€	0,352	0,335	0,322	0,313



80277.Y

Reflexná samolepka - ruka

55 x 67 mm  
tampoprint

ks	1-999	1000+	5000+	10000+
€	0,148	0,139	0,135	0,130



34440.Q

Detská bezpečnostná sada, 5 dielov

180 x 400 x 50 mm  
sietotlač, transfer

ks	1-29	30+	150+	300+
€	7,391	7,130	6,870	6,696

detská bezpečnostná vesta  
(splňa EN 1150), samolepka  
opičky, reflexný medvedík so  
šnůrkou, bezpečnostný pásik  
na ruku, batoh

51323.M



51324.R



51325.B



51328.Z



51327.Y

Guličkové pero s hrou bludisko

Ø 11 x 150 mm  
tampoprint

ks	1-399	400+	2000+	4000+
€	0,457	0,439	0,422	0,413

novinka





# Šport, hry a voľný čas

novinka

30420.P

Hra Kameň – papier – nožnice,  
dve kocky v bavlnenom vrecku

85 x 125 mm (vrecko)  
sietotlač

ks	1-99	100+	500+	1000+
€	1,830	1,761	1,700	1,661



51404.C

Sada so žolíkovými kartami

155 x 120 x 30 mm  
tampoprint, sietotlač

ks	1-39	40+	200+	400+
€	5,565	5,391	5,174	5,043



44923.C

Žolíkové karty a hracie kocky  
v darčekovom balení

152 x 98 x 32 mm  
tampoprint, sietotlač

ks	1-49	50+	250+	500+
€	3,900	3,717	3,452	3,222



35507.P

Sada spoločenských hier  
v drevenom boxe 6v1

300 x 300 x 75 mm  
tampoprint, sietotlač, laserový popis

ks	1-7	8+	40+	80+
€	22,217	21,391	20,609	20,130

šach, backgammon, cribbage,  
karty, domino, kockový poker

51248.P

Spoločenské hry 4v1  
v drevenom boxe

165 x 165 x 28 mm  
tampoprint, laserový popis

ks	1-49	50+	250+	500+
€	4,391	4,243	4,091	3,996

domino, mikádo, dáma a šach



51413.S

Hracie karty  
v kovovom boxe

65 x 95 x 18 mm  
tampoprint, laserový popis

ks	1-129	130+	650+	1300+
€	1,483	1,430	1,378	1,348





## 16023.S

## Piškvorky v hliníkovom obale

175 x 115 x 20 mm  
tampoprint, laserový popis

ks	1-19	20+	100+	200+
€	10,163	9,551	9,224	8,980



## 35595.C

## Veľká pokerová hra so stolovou podložkou v darčekom boxe

novinka

265 x 115 x 115 mm (box)  
sieťotlač, laserový popis

ks	1-7	8+	40+	80+
€	22,174	21,348	20,565	20,087

3x50 a 2x25 žetónov, 2 balíčky kariet, 5 kociek, krupierov žetón, zelená pokerová hracia podložka

## 80279.C

## Pokerový set s dvomi pohárkami

novinka

270 x 120 x 40 mm  
sieťotlač (na obal)

ks	1-49	50+	250+	500+
€	4,435	4,270	4,104	3,996



100 žetónov,  
1 balíček hracích kariet,  
2 štýlové poháre 58 ml

## 35575.S

## Pokerová sada v kufříku

210 x 210 x 65 mm  
laserový popis

ks	1-9	10+	50+	100+
€	19,739	19,000	18,304	17,913



4x25 žetónov, 2 balíčky kariet, 5 kociek, krupierov žetón, žetóny pre malé aj veľké povinné stávky

2 balíčky hracích kariet, 240 žetónov, krupierov žetón



## 80278.C

## Veľký pokerový set na otočnom podstavci

novinka

Ø 179 x 100 mm

ks	1-14	15+	75+	150+
€	13,217	12,696	12,174	11,870



novinka

Malý basketbalový kôš  
s loptou a prísavkami

200 x 160 mm  
tampoprint

ks	1-69	70+	350+	700+
€	2,743	2,630	2,530	2,465



80240.C



80238.R



80239.M



80242.Q

Mini stolový futbal  
s dvoma loptičkami

510 x 310 x 105 mm  
laserový popis

ks	1-9	10+	50+	100+
€	26,348	25,261	24,261	23,652



Dodávané nezmontované vrátane skrutkovača.  
Vyrobené z drevovláknitej odolnej dosky MDF.



16032.C

Sada šiestich magnetických  
šípok s veľkým terčom

410 x 473 mm  
sietotlač

ks	1-19	20+	100+	200+
€	9,020	8,490	8,163	8,000







**30403.C**

**Čierny skladací kompas**

143 x 58 x 23 mm  
tampoprint

ks	1-69	70+	350+	700+
€	2,822	2,717	2,622	2,561



**36083.C**

**Ďalekohľad 10 x 50**

185 x 195 x 75 mm (puzdro)  
sieťotlač, transfer (puzdro)

ks	1-4	5+	25+	50+
€	33,304	32,087	30,957	30,217



**80246.S**

**Kovový kompas s krúžkom**

Ø 43 x 10 mm  
tampoprint, laserový popis

ks	1-199	200+	1000+	2000+
€	1,009	0,965	0,926	0,904

**Sada vreckového noža**

**a LED baterky v darčekovom boxe**

135 x 90 x 27 mm (krabička)  
tampoprint, laserový popis

ks	1-29	30+	150+	300+
€	6,217	5,957	5,739	5,565

nôž so siedmimi funkciami



80244.M



80245.C



80243.R



**42848.S**

**Darčeková sada kompasu, baterky a noža**

175 x 75 x 25 mm  
tampoprint, laserový popis

ks	1-29	30+	150+	300+
€	7,174	6,826	6,522	6,348





30400.J

Profesionálny lietajúci drak

novinka

1250 x 600 x 140 mm (drak),  
885 x 120 mm (puzdro)  
sietotlač (na puzdro)

ks	1-9	10+	50+	100+
€	18,478	17,826	17,174	16,783



30404.C

Badminton  
v obale s popruhom

630 x 215 x 30 mm  
sietotlač (na obal)

ks	1-39	40+	200+	400+
€	4,826	4,609	4,478	4,348



42284.M

Sada na petanque

oceľové gule  
225 x 150 x 65 mm  
sietotlač

ks	1-24	25+	125+	250+
€	8,652	8,000	7,435	6,957



16033.C

Tréningová golfová sada

170 x 100 x 390 mm (vak)  
tampoprint, laserový popis

ks	1-7	8+	40+	80+
€	30,408	28,531	27,510	26,898



42290.B

Golfová loptička Titanium  
(cena za 1 ks, balenie 3/12 ks)

Ø 45 mm  
tampoprint

ks	3-199	200+	1000+	2000+
€	0,861	0,796	0,739	0,691



novinka

**30408.M**  
Pikniková flísová deka  
s vodoodolnou PVC  
podšivkou a držadlom

1 600 x 1 250 x 5 mm  
sietotlač, transfer

ks	1-9	10+	50+	100+
€	17,261	16,609	16,043	15,652



**50071.M**  
Komfortná domáca  
modrá flísová deka

1 500 x 1 250 mm (deka)  
flís 240 g/m<sup>2</sup>  
výšivka (deka), tampoprint, sietotlač (štítok)

ks	1-14	15+	75+	150+
€	12,739	12,261	11,826	11,565



**30407.Q**  
Kockovaná flísová deka  
v nylónovom obale

1 500 x 1 200 mm (deka)  
340 x 200 mm (obal)  
flís 200 g/m<sup>2</sup>  
výšivka (deka), transfer (obal)

ks	1-29	30+	150+	300+
€	8,609	8,304	8,000	7,826



30410.J

30409.F



Flísová pikniková deka  
v nylónovom obale

1 500 x 1 200 mm  
flís 200 g/m<sup>2</sup>  
výšivka (deka), transfer (obal)

ks	1-29	30+	150+	300+
€	7,261	7,000	6,739	6,609



30412.C

30413.M

30411.Z

30414.R

30416.O

30415.L

30417.Z

30419.E



s klipom na opasok



**Krokomer s meračom kalórií a vzdialenosti**

novinka

41 x 50 x 24 mm  
tampoprint

ks	1-49	50+	250+	500+
€	4,013	3,865	3,726	3,639



**30147.C**

Palice na nordic walking

50 x 790 mm  
tampoprint, laserový popis

ks	1-9	10+	50+	100+
€	19,739	19,000	18,304	17,913

novinka

**50343.M**

Osviežujúci ručný sprej na tvár

Ø 40 x 210 mm  
tampoprint

ks	1-69	70+	350+	700+
€	2,857	2,748	2,652	2,591

dodávaný nenaplnený



**44990.M**

Senzorový merač telesného tuku kombinovaný s hodinami a alarmom

118 x 74 x 16 mm  
tampoprint

ks	1-79	80+	400+	800+
€	2,448	2,357	2,274	2,222



automatický výpočet Body Mass Indexu

dotykové senzory pre ľahké meranie



**50340.0**



Švihadlo s počítadlom preskokov i spálených kalórií

3 300 x 135 x 55 mm  
tampoprint

ks	1-59	60+	300+	600+
€	3,657	3,522	3,396	3,317



**50339.M**



ks	1-89	90+	450+	900+
€	2,217	2,135	2,061	2,013

**Športový fitness uterák**

Ø 80 x 150 mm (obal)  
300 x 300 mm (uterák)  
uterák: 80 % polyester, 20 % nylon  
sietotlač, transfer, výšivka



52209.0

52208.M

**Športový fitness uterák  
v nylónovom obale**

800 x 400 mm (uterák)  
70 x 140 x 50 mm (obal)  
uterák: 70 % polyester, 30 % polyamid  
sietotlač, transfer, výšivka



50065.M

50066.Z

ks	1-39	40+	200+	400+
€	4,609	4,435	4,274	4,174



50070.Z

**Plastová fľaša na nápoje**

500 ml / 75 x 210 x 60 mm  
polypropylén  
tampoprint, sietotlač

ks	1-89	90+	450+	900+
€	2,300	2,213	2,135	2,087



50069.0

50067.M

50068.J



50074.M

**Plastová fľaša na nápoje  
so slámkou a očkom**

650 ml / Ø 69 x 247 mm  
polykarbonát  
tampoprint

ks	1-59	60+	300+	600+
€	3,278	3,157	3,043	2,974



50075.J



50076.0



80252.M

**Rozlišovací dres pre dospelých**

polyester 190T  
sietotlač, transfer

ks	1-99	100+	500+	1000+
€	2,035	1,952	1,874	1,826



80250.Y



80251.R



80253.Z



30348.M



30349.O



30347.B



30350.R



**Fandiace rukavice s tleskacími vankúšikmi**

novinka

120 x 160 x 10 mm  
transfer

ks	1-69	70+	350+	700+
€	2,909	2,804	2,704	2,639

30340.B

**Farby na tvár pre fanúšikov**

novinka

134 x 71 x 1 mm  
sietotlač, tampoprint

ks	1-399	400+	2000+	4000+
€	0,530	0,509	0,491	0,478



46023.R

46025.Z

46024.M

46022.Y

46021.B



**Lietajúci tanier**

Ø 220 mm  
sietotlač

ks	1-199	200+	600+	1500+
€	0,809	0,778	0,748	0,722

43234.Z

43231.M

**Frisbee – skladací lietajúci tanier a puzdro z nylónu**

Ø 245 mm, puzdro 90 x 100 mm  
sietotlač, transfer

ks	1-299	300+	1500+	3000+
€	0,604	0,557	0,517	0,483

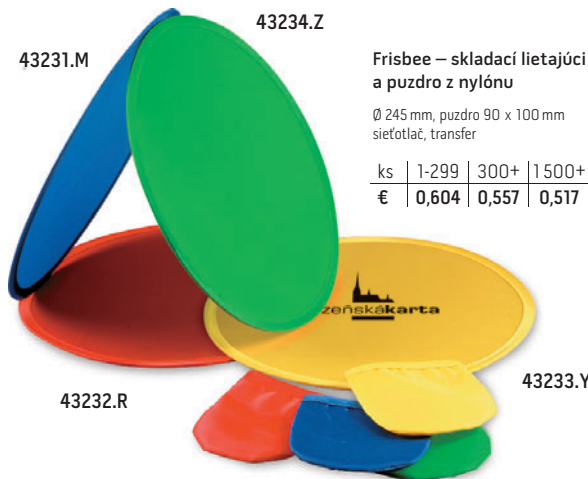

43232.R

43233.Y

**Plážová nafukovacia lopta**

nafúknutá: Ø 250 mm  
vyfúknutá: dĺžka pola 370 mm  
tampoprint, sietotlač

ks	1-199	200+	1000+	2000+
€	0,817	0,787	0,757	0,739

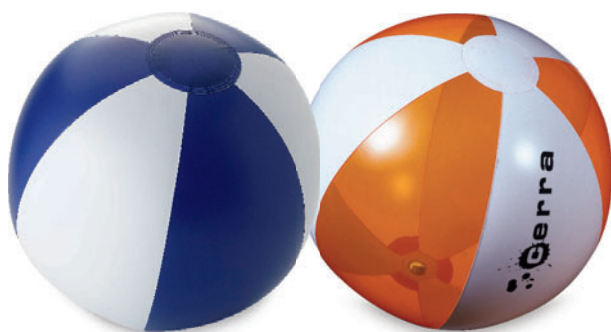

35168.M

30142.O



35160.Q



30143.M



30144.Y



Tyče BAM-BAM pre fanúšikov

600 x 108 mm  
sietotlač

51307.B



ks	1-599	600+	3 000+	6 000+
€	0,313	0,300	0,287	0,283

51306.M



51308.0

30345.R



30342.B



30343.M



Plastová húkačka na šnúrke

novinka

Ø 45 x 75 mm  
tampoprint

ks	1-99	100+	500+	1 000+
€	1,830	1,761	1,700	1,661



30344.0

52202.R



52205.Z

52201.M

52204.0

Ručná klapačka

185 x 85 x 19 mm  
tampoprint

ks	1-499	500+	2 500+	5 000+
€	0,409	0,391	0,378	0,370

52203.Y



51301.M

51302.R



51303.B

Trúbka pre fanúšikov

365 x 55 x 55 mm  
tampoprint

ks	1-129	130+	650+	1 300+
€	1,552	1,491	1,439	1,404

Nylónová podložka na sedenie s PE penou

345 x 260 x 10 mm  
transfer

ks	1-139	140+	700+	1 400+
€	1,387	1,335	1,287	1,257



50188.R



50192.0



50191.M

# Reklamný textil

## TESS 160

tričko unisex s krátkym rukávom zo 100% bavlny gramáže 160 g/m<sup>2</sup>, prídavok elastanu vo výstrihu okolo krku kvôli jeho tvarovej stálosti, po stranách bez švov, spevňujúca ramenná páska

sietotlač, transfer, výšivka



biela XS–XXL

ks	1-79	80+	400+	800+
€	2,535	2,413	2,300	2,248

ostatné farby XS–XXL

ks	1-69	70+	350+	700+
€	2,743	2,613	2,491	2,435

biela XXXL a väčšie

ks	1-69	70+	350+	700+
€	2,904	2,765	2,635	2,574

ostatné farby XXXL a väčšie

ks	1-69	70+	350+	700+
€	3,117	2,965	2,826	2,761



8600x.B\*  
biela

8604x.R  
červená

8608x.Y  
žltá

8609x.O  
oranžová

8606x.Z  
zelená



8602x.M  
kráľovská modrá

8601x.M\*  
námornícka modrá

8605x.Z  
fľašková zelená

8607x.J  
šedá

8603x.C\*  
čierna

Namiesto „x“ doplňte v kóde požadovanú veľkosť:  
0=XS, 1=S, 2=M, 3=L, 4=XL, 5=XXL, 6=XXXL, \* 7=XXXXL

## všetko novinky

## GART 190

tričko unisex s krátkym rukávom zo 100% bavlny gramáže 190 g/m<sup>2</sup>, prídavok elastanu vo výstrihu okolo krku kvôli jeho tvarovej stálosti, po stranách bez švov, spevňujúca ramenná páska

sietotlač, transfer, výšivka



biela S–XXL

ks	1-59	60+	300+	600+
€	3,270	3,109	2,965	2,900

ostatné farby S–XXL

ks	1-49	50+	250+	500+
€	3,578	3,404	3,243	3,170

biela XXXL

ks	1-49	50+	250+	500+
€	4,435	4,226	4,030	3,939

ostatné farby XXXL

ks	1-39	40+	200+	400+
€	4,870	4,652	4,435	4,322



8616x.B  
biela

8612x.R  
červená

8617x.O  
oranžová

8614x.M  
kráľovská modrá



8611x.Z  
fľašková zelená

8613x.M  
námornícka modrá

8610x.J  
šedá

8615x.C  
čierna

Namiesto „x“ doplňte v kóde požadovanú veľkosť:  
1=S, 2=M, 3=L, 4=XL, 5=XXL, 6=XXXL





# Stedman®

## STEDMAN 155

značkové tričko tubulárneho strihu zo 100% prstencovo pradenej bavlny gramáže 155 g/m<sup>2</sup> (farba šedý melír má zloženie 85% bavlny a 15% viskózy), spevňujúca ramenná páska, po stranách bez švov

sietotlač, transfer, výšivka



7239x.Z  
svetlozelená

### biela

ks	1-95	96+	960+	1920+
€	3,374	2,822	2,496	2,439

### ostatné farby

ks	1-95	96+	960+	1920+
€	4,278	3,565	3,174	3,100



7230x.B  
biela



7231x.Y  
žltá



7232x.O  
oranžová



7233x.R  
červená



7234x.M  
svetlomodrá



7235x.M  
národná modrá



7236x.M  
oceánovo modrá



7237x.M  
kráľovská modrá



7238x.M  
tmavomodrá



7240x.Z  
stredne zelená



7241x.Z  
fľašková zelená



7242x.J  
svetlošedý melír



7243x.K  
šedý melír\*



7244x.C  
čierna

\*zloženie: 85% bavlny a 15% viskózy

Namiesto „x“ doplňte v kóde požadovanú veľkosť:  
1=S, 2=M, 3=L, 4=XL, 5=XXL, 6=XXXL

## SLAZENGER 150

značkové tričko tubulárneho strihu zo 100% džersejovej bavlny gramáže 150 g/m<sup>2</sup>, okolo výstrihu je rebrový úplet s elastanom, ramenné švy spevňuje lem

sietotlač, transfer, výšivka



### biela

ks	1-49	50+	250+	500+
€	4,522	4,348	4,196	4,100

### ostatné farby

ks	1-39	40+	200+	400+
€	5,000	4,826	4,652	4,522



9810x.B  
biela



9816x.R  
červená



9824x.Z  
zelené jablko



9823x.M  
akvamarínová



9822x.M  
národná modrá



9833x.M  
modrá klasik



9831x.J  
športová šedá\*



9828x.J  
šedá



9832x.C  
čierna

\*zloženie: 90% bavlny a 10% viskózy





9845x.K  
tmavošedá

**SLAZENGER 190**

značkové tričko tubulárneho strihu zo 100% džersejovej bavlny gramáže 180-190 g/m<sup>2</sup>, okolo výstrihu je rebrový úplet s elastanom, ramenné švy spevňuje lem

sietotlač, transfer, výšivka

biela

ks	1-39	40+	200+	400+
€	6,043	5,870	5,696	5,565

ostatné farby

ks	1-29	30+	150+	300+
€	6,478	6,261	6,000	5,870



9835x.B  
biela

9838x.R  
červená

9847x.M  
modrá klasik

9840x.M  
národná modrá

9841x.J  
športová šedá\*

9842x.C  
čierna

\*zloženie: 90 % bavlny a 10 % viskózy



Namiesto „x“ doplňte v kóde požadovanú veľkosť:  
1 = S, 2 = M, 3 = L, 4 = XL, 5 = XXL, 6 = XXXL

novinka

**CHIP SLAZENGER 145**

značkové tričko z príjemného zmesového materiálu single džersej z 60% polyesteru a 40% bavlny gramáže 145 g/m<sup>2</sup> (šedá farba 7293x.J má zloženie 65% polyester a 35% bavlna), výrazné lemovanie výstrihu a manžetiek, logo Slazenger na spodnom bočnom šve

sietotlač, transfer, výšivka

ks	1-19	20+	100+	200+
€	9,870	9,478	9,130	8,957



7290x.R  
červená



7291x.M  
modrá



7292x.Z  
zelená



7293x.J  
šedá



**ADELAIDE CONTRAST 150**

značkové tričko tubulárneho strihu zo 100% džersejovej bavlny gramáže 150 g/m<sup>2</sup>, úpletový výstrih a lemy rukávov sú v kontrastnej farbe

sietotlač, transfer, výšivka

ks	1-39	40+	200+	400+
€	5,565	5,348	5,174	5,043



9890x.B  
biela/národná modrá



9898x.B  
biela/čierna



9893x.O  
oranžová/biela



9894x.M  
nebeská modrá/biela



9895x.M  
kráľovská modrá/žltá



9892x.R  
červená/biela



9899x.R  
červená/žltá



9896x.M  
národná modrá/biela



9897x.C  
čierna/červená

Namiesto „x“ doplňte v kóde požadovanú veľkosť:  
1 = S, 2 = M, 3 = L, 4 = XL, 5 = XXL



**KAWARTHA ELEVATE "V" 200**

značkové tričko s výstrihom do "V" zo superjemnej strečovej tkaniny zloženej z 95% organickej bavlnenej priadze so zvýšeným zákrutom a 5% elastanu gramáže 200 g/m<sup>2</sup>, bočné švy, potlač loga tón v tóne v spodnej časti chrbta, zamatová ramenná lemovka, prešíty štítok na vonkajšej spodnej časti chrbta

sietotlač, transfer, výšivka

novinka

ks	1-19	20+	100+	200+
€	11,087	10,696	10,304	10,043



7341x.B  
biela



7342x.R  
červená



7344x.M  
modrá



7345x.M  
národná modrá



7346x.K  
antracitová



7347x.C  
čierna

**ELEVATE**



7343x.F  
fialová

Namiesto „x“ doplňte v kóde požadovanú veľkosť:  
1=S, 2=M, 3=L, 4=XL, 5=XXL, 6=XXXL

novinka

**COOL – DRI HANES 145**

značkové unisexové športové tričko z Cool-DRI materiálu zo 100% polyesteru gramáže 145 g/m<sup>2</sup>, výstrih pri krku v zhodnej tkanine, bočné švy, raglánové rukávy

sietotlač, transfer, výšivka



7359x.O  
oranžová

biela

ks	1-35	36+	360+	720+
€	9,435	7,870	7,000	6,826

ostatné farby

ks	1-35	36+	360+	720+
€	10,913	9,087	8,087	7,913



7357x.B  
biela



7358x.Y  
žltá



7360x.R  
červená



7361x.M  
kráľovská modrá



7362x.M  
národná modrá



7363x.Z  
stredne zelená



7364x.C  
čierna



**COOL FIT CONTRAST 200**

značkové športové tričko z jednoduchého dzersejového zmesového úpletu gramáže 200 g/m<sup>2</sup> zloženého z 95% polyesterového materiálu Cool Fit a 5% elastanu s kontrastným prešíťím a logom značky SLAZENGER, výstrih okolo krku v rovnakej tkanine, raglánové rukávy

sietotlač, transfer, výšivka

ks	1-9	10+	50+	100+
€	16,043	15,435	14,870	14,522



9581x.B  
biela



9583x.C  
čierna



9585x.Z  
zelené jablko



9582x.M  
národná modrá

Namiesto „x“ doplňte v kóde požadovanú veľkosť:  
1=S, 2=M, 3=L, 4=XL, 5=XXL



**Dámske tričko SANDRA 170**

dámske tričko s krátkym rukávom z príjemného elastického materiálu z 95% bavlny a 5% elastanu (vďaka ktorému tričko drží tvar a zvýrazňuje dámsku postavu) gramáže 170 g/m<sup>2</sup>, mierne predĺžená dĺžka, bočné švy, spevňujúca ramenná páska

sietotlač, transfer, výšivka

ks	1-59	60+	300+	600+
€	3,270	3,109	2,965	2,900



8626x.B  
biela



8625x.Y  
žltá



8623x.I  
tyrkysová



8621x.R  
červená



8620x.Z  
zelená



8622x.M  
národná modrá



8624x.C  
čierna

Namiesto „x“ doplňte v kóde požadovanú veľkosť:  
0=XS, 1=S, 2=M, 3=L, 4=XL, 5=XXL

všetko  
novinky

**Stedman®**

**Dámske tričko STEDMAN CLASSIC 155**

dámske značkové tričko zo 100% prstencovo pradenej bavlny gramáže 155 g/m<sup>2</sup> (farba šedý melír má zloženie 85% bavlny a 15% viskózy), spevňujúca ramenná páska, bočné švy

sietotlač, transfer, výšivka



7247x.Y  
žltá

biela

ks	1-95	96+	960+	1920+
€	3,374	2,822	2,496	2,439

ostatné farby

ks	1-95	96+	960+	1920+
€	4,278	3,565	3,174	3,100



7246x.B  
biela



7248x.O  
oranžová



7249x.R  
červená



7250x.E  
ružová



7251x.M  
svetlomodrá



7252x.M  
oceánovo modrá



7253x.M  
kráľovská modrá



7254x.M  
národná modrá



7255x.Z  
svetlozelená



7256x.Z  
stredne zelená



7257x.K  
šedý melír



7258x.C  
čierna

Namiesto „x“ doplňte v kóde požadovanú veľkosť:  
1=S, 2=M, 3=L, 4=XL, 5=XXL



**LADY KAWARTHA ELEVATE "V" 200**  
 značkové tričko s výstrihom do "V" zo superjemnej strečovej tkaniny zloženej z 95% organickej bavlnenej priadze so zvýšeným zákrutom a 5% elastanu gramáže 200 g/m<sup>2</sup>, bočné švy, potlač loga tón v tóne v spodnej časti chrbta, zamatová ramenná lemovka, prešíty štítok na vonkajšej spodnej časti chrbta

sietotlač, transfer, výšivka



7349x.B  
 biela

novinka

ks	1-19	20+	100+	200+
€	11,087	10,696	10,304	10,043



7350x.R  
 červená



7351x.F  
 fialová



7352x.M  
 modrá



7353x.M  
 námornícka modrá



7354x.K  
 antracitová



7355x.C  
 čierna

Namiesto „x“ doplňte v kóde požadovanú veľkosť:  
 1=S, 2=M, 3=L, 4=XL, 5=XXL



7713x.F  
 svetlo fialová

**Dámske tričko LADY RALLY 180**  
 dámske značkové tričko z 95% bavlny a 5% elastanu gramáže 170-180 g/m<sup>2</sup> vypasovaného strihu s bočnými rázporkami a módnym tvarom výstrihu so spevňujúcou lemoučkou. Dvojvrstvový predný panel. Logo Slazenger je aplikované vzadu na ramene

sietotlač, transfer, výšivka

ks	1-14	15+	75+	150+
€	13,565	13,043	12,609	12,304



7710x.B  
 biela



7712x.R  
 červená



7714x.C  
 čierna

Namiesto „x“ doplňte v kóde požadovanú veľkosť:  
 1=S, 2=M, 3=L, 4=XL



**LADY CHIP SLAZENGER 145**  
 značkové dámske tričko z príjemného zmesového materiálu single džersej z 60% polyesteru a 40% bavlny gramáže 145 g/m<sup>2</sup> (šedá farba 7298x.J má zloženie 65% polyester a 35% bavlna), výrazné lemovanie výstrihu a manžetiek, logo Slazenger na spodnom bočnom šve

sietotlač, transfer, výšivka

ks	1-19	20+	100+	200+
€	9,870	9,478	9,130	8,957

novinka



7296x.M  
 modrá



7297x.Z  
 zelená



7298x.J  
 šedá



7295x.R  
 červená



Tričko s dlhým rukávom KAMBA 160  
tričko unisex s dlhým rukávom zo 100% bavlny gramáže  
160 g/m<sup>2</sup>, prídavok elastanu vo výstrihu na krk kvôli tvarovej  
stálosti, po stranách bez švov, spevňujúca ramenná páska

sietotlač, transfer, výšivka

ks	1-39	40+	200+	400+
€	4,609	4,391	4,178	4,083



8655x.B  
biela



8651x.R  
červená



8652x.M  
národnica modrá



8650x.J  
svetlošedý melír



8654x.C  
čierna

Namiesto „x“ doplňte v kóde  
požadovanú veľkosť:  
1=S, 2=M, 3=L, 4=XL,  
5=XXL, 6=XXXL

všetko  
novinky

Detské tričko STEDMAN CLASSIC 155  
detské značkové tričko tubulárneho strihu zo 100% prstencovo  
pradenej bavlny gramáže 155 g/m<sup>2</sup> (farba šedý melír má zloženie  
85% bavlny a 15% viskózy), spevňujúca ramenná páska,  
po stranách bez švov

sietotlač, transfer, výšivka



Stedman®

biela

ks	1-95	96+	960+	1920+
€	3,043	2,548	2,252	2,200

ostatné farby

ks	1-95	96+	960+	1920+
€	3,904	3,248	2,909	2,839



7260x.B  
biela



7264x.E  
ružová



7261x.Y  
žltá



7262x.O  
oranžová



7263x.R  
červená



7265x.M  
svetlomodrá



7266x.M  
kráľovská modrá



7267x.M  
národnica modrá



7268x.M  
tmavomodrá



7269x.Z  
stredne zelená



7270x.Z  
fľašková zelená



7271x.J  
svetlošedý melír



7272x.K  
šedý melír



7273x.C  
čierna

Namiesto „x“ doplňte v kóde požadovanú veľkosť:

0=XS (110-116/5-6), 1=S (122-128/7-8), 2=M (134-140/9-10),  
3=L (146-152/11-12), 4=XL (158-164/12-13)



**Polokošeľa ECONOMY FIRST 160**  
značková polokošeľa z piqué úpletu zo 100% bavlny  
gramáže 160 g/m<sup>2</sup>, 1 / 1 plochý rebrovany úplet  
goliera, 2 gombíky vo farbe. Golier je spevnený  
lemovkou z rovnakej tkaniny.

sietotlač, transfer, výšivka

ks	1-29	30+	150+	300+
€	6,652	6,391	6,174	6,043



9490x.B  
biela



9499x.Y  
tmavožltá



9491x.R  
červená



9492x.O  
oranžová



9496x.Z  
zelené jablko



9501x.M  
svetlomodrá



9495x.M  
nebeská modrá



9493x.M  
modrá klasik



9500x.F  
fialová



9494x.M  
národnická modrá



9497x.J  
šedý melír\*



9502x.J  
šedá



9498x.C  
čierna

Namiesto „x“ doplňte v kóde  
požadovanú veľkosť:  
1=S, 2=M, 3=L, 4=XL,  
5=XXL, 6=XXXL, 7=XXXXL

\*zloženie: 85 % bavlny a 15 % viskózy



**Dámska polokošeľa ECONOMY FIRST 160**  
dámska značková polokošeľa z piqué úpletu zo  
100% bavlny gramáže 160 g/m<sup>2</sup>, 1/1 plochý rebrový  
úplet goliera, 4 gombíky vo farbe. Golier je spevnený  
lemovkou z rovnakej tkaniny

sietotlač, transfer, výšivka

ks	1-29	30+	150+	300+
€	6,652	6,391	6,174	6,043



7670x.B  
biela



7671x.Y  
tmavožltá



7672x.R  
červená



7673x.O  
oranžová



7674x.F  
fialová



7675x.M  
svetlomodrá



7676x.M  
modrá klasik



7677x.M  
národnická modrá



7678x.M  
nebeská modrá



7679x.Z  
zelené jablko



7680x.J  
šedá



7681x.J  
šedý melír\*



7682x.C  
čierna

Namiesto „x“ doplňte v kóde  
požadovanú veľkosť:  
1=S, 2=M, 3=L, 4=XL, 5=XXL

\*zloženie: 85 % bavlny a 15 % viskózy





**Polokošeľa DANY 190**

polokošeľa unisex z príjemného jemnejšieho úpletu double pique zo 100% bavlny gramáže 190 g/m<sup>2</sup>, golier a manžety rukávov sú zakončené rebrovým úpletom, bočné švy, 3 transparentné gombíky vo farbe polokošeľa

sieťotlač, transfer, výšivka

biela

ks	1-29	30+	150+	300+
€	5,783	5,522	5,261	5,130

ostatné farby

ks	1-29	30+	150+	300+
€	6,043	5,739	5,478	5,348



8636x.B  
biela



8632x.R  
červená



8637x.O  
oranžová



8631x.Z  
zelená



8634x.M  
kráľovská modrá



8633x.M  
národná modrá



8630x.J  
šedá



8635x.C  
čierna

všetko  
novinky

Namiesto „x“ doplňte v kóde požadovanú veľkosť:  
1=S, 2=M, 3=L, 4=XL, 5=XXL, 6=XXXL

7331x.R  
červená/biela



ELEVATE

**POLO CALGARY ELEVATE 200**

značková pohodlná polokošeľa z piqué úpletu zo 100% bavlny gramáže 200 g/m<sup>2</sup>, 1x1 rebrový úplet výstrihu a manžetiek, predzrážané, zamatová lemovka vo výstrihu a bočnom rozparku, potlač loga tón v tóne v spodnej časti chrbta, 2 gravírované gombíky

sieťotlač, transfer, výšivka

ks	1-14	15+	75+	150+
€	13,565	13,043	12,609	12,304



7328x.B  
biela



7330x.R  
červená



7332x.O  
oranžová



7333x.F  
fialová



7334x.M  
svetlomodrá



7335x.M  
modrá



7336x.M  
národná modrá



7337x.Z  
fľašková zelená



7338x.Z  
zelené jablko



7339x.K  
antracitová



7340x.C  
čierna



7329x.B  
biela/národná modrá

K dispozícii tiež v dámskom a detskom prevedení pod kódmi 38081\* (dámske) a 38082\* (detské).





**SLAZENGER COTTON POLO 220**

značková polokošeľa z piqué úpletu, 100% česaná bavlna hebká na dotyk, gramáž 200-220 g/m<sup>2</sup>, golier a manžety rukávov z plochého úpletu 1/1, zapínanie na 2 gombíky s razbou

sietotlač, transfer, výšivka

ks	1-19	20+	100+	200+
€	12,957	12,478	12,000	11,739



**9720x.B**  
biela



**9723x.P**  
khaki béžová



**9728x.R**  
tmavočervená



**9741x.Z**  
zelené jablko



**9731x.M**  
svetlomodrá



**9737x.M**  
akvamarínová



**9746x.M**  
modrá klasik



**9736x.M**  
námornícka modrá



**9743x.J**  
šedá



**9744x.J**  
športová šedá\*



**9745x.C**  
čierna

\*zloženie: 90% bavlny a 10% viskózy

Namiesto „x“ doplňte v kóde požadovanú veľkosť:  
1=S, 2=M, 3=L, 4=XL, 5=XXL, 6=XXXL

**LADY SLAZENGER COTTON POLO 220**

dámska značková polokošeľa z piqué úpletu zo 100% česanej bavlny gramáže 200-220g/m<sup>2</sup>, 1x1 plochý rebrový úplet goliera a manžety rukávov, výstrih s dvoma gombíkmi vo farbe, potlačený spevňujúci lem goliera, vypasovaný strih

sietotlač, transfer, výšivka

ks	1-19	20+	100+	200+
€	12,957	12,478	12,000	11,739



**7620x.B**  
biela



**7623x.P**  
khaki béžová



**7628x.R**  
tmavočervená



**7641x.Z**  
zelené jablko



**7631x.M**  
svetlomodrá



**7637x.M**  
akvamarínová



**7646x.M**  
modrá klasik



**7636x.M**  
námornícka modrá



**7644x.J**  
športová šedá\*



**7645x.C**  
čierna

Namiesto „x“ doplňte v kóde požadovanú veľkosť:  
1=S, 2=M, 3=L, 4=XL

\*zloženie: 90% bavlny a 10% viskózy



**7643x.J**  
šedá



novinka

**Polokošeľa STRIKER COOL FIT 125**  
značková polokošeľa z Cool Fit sieťoviny zo 100% polyesteru gramáže 125 g/m<sup>2</sup>. Raglánové rukávy s plochým stehovaním, 3 gombíky vo farbe, spevňujúca lemovka výstrihu v rovnakej tkanine

sietotlač, transfer, výšivka

ks	1-29	30+	150+	300+
€	8,043	7,739	7,435	7,261



7220x.B  
biela



7221x.Y  
žltá



7222x.R  
červená



7225x.Z  
zelené jablko



7223x.O  
oranžová



7224x.M  
národná modrá



7226x.C  
čierna

Namiesto „x“ doplňte v kóde požadovanú veľkosť:  
1=S, 2=M, 3=L, 4=XL, 5=XXL, 6=XXXL



**Dámska polokošeľa STRIKER COOL FIT 125**  
dámska značková polokošeľa z Cool Fit sieťoviny zo 100% polyesteru gramáže 125 g/m<sup>2</sup>. Raglánové rukávy s plochým stehovaním, 4 gombíky vo farbe, spevňujúca lemovka výstrihu v rovnakej tkanine

sietotlač, transfer, výšivka

ks	1-29	30+	150+	300+
€	8,043	7,739	7,435	7,261



7210x.B  
biela



7211x.Y  
žltá



7212x.R  
červená



7215x.Z  
zelené jablko



7214x.M  
národná modrá



7216x.C  
čierna



7213x.O  
oranžová

Namiesto „x“ doplňte v kóde požadovanú veľkosť:  
1=S, 2=M, 3=L, 4=XL



7366x.B  
biela

7367x.R  
červená

7368x.O  
oranžová

7369x.M  
nebeská modrá



7370x.M  
národná modrá

7371x.Z  
svetlozelená

7372x.J  
šedá

7373x.C  
čierna

Namiesto „x“ doplňte v kóde požadovanú veľkosť:  
1=S, 2=M, 3=L, 4=XL, 5=XXL



novinka

**BACKHAND SLAZENGER POLO 260**  
značková polokošľa zo 100% jemne  
česanej bavlny gramáže 250-260 g/m<sup>2</sup>,  
štýlové zapínanie 1 gombíkom, 1x1 plochý  
rebrový úplet výstrihu s embosovaným  
lemom, kontrastné lemy na ramenách  
a bočných švoch

sietotlač, transfer, výšivka

ks	1-7	8+	40+	80+
€	22,174	21,348	20,565	20,087

K dispozícii tiež v dámskom prevedení  
pod kódmi 33092\*.



**Polokošľa ERIE 180**  
značková polokošľa z piqué úpletu zo 100% bavlny gramáže  
180 g/m<sup>2</sup>, 1x1 plochý rebrový steh goliera a manžetiek  
s lemovaním, spevňujúca lemovka výstrihu v rovnakej tkanine.  
Pánsky strih s dvoma gombíkmi vo farbe, dámsky strih so  
štvor-gombíkovým výstrihom a postrannými rázporkami

sietotlač, transfer, výšivka

ks	1-19	20+	100+	200+
€	10,478	10,087	9,739	9,522



K dispozícii tiež v dámskom  
prevedení pod kódmi 31099\*.



7500x.B  
biela/čierna

7501x.R  
červená/biela

7502x.M  
modrá klasik/biela

7503x.M  
národná modrá/biela

7504x.C  
čierna/biela

Namiesto „x“ doplňte v kóde požadovanú veľkosť:  
1=S, 2=M, 3=L, 4=XL, 5=XXL, 6=XXXL, 7=XXXXL

**COOL FIT POLO 220**  
značková športová polokošľa s kontrastným prešíťm  
z moderného 100% polyesterového materiálu Cool Fit  
gramáže 200-220 g/m<sup>2</sup>, rozhalenka na 3 gombíky

sietotlač, transfer, výšivka

ks	1-7	8+	40+	80+
€	27,130	26,130	25,217	24,609



9941x.B  
biela

9944x.M  
národná modrá

9942x.R  
červená

9943x.M  
nebeská modrá

Namiesto „x“ doplňte v kóde požadovanú veľkosť:  
1=S, 2=M, 3=L, 4=XL, 5=XXL



9945x.C  
čierna



**SLAZENGER COTTON POLO 220 LONG SLEEVE**  
 značková polokošeľa s dlhým rukávom z piqué úpletu zo 100% česanej bavlny gramáže 200-220 g/m<sup>2</sup>, 1x1 plochý rebrový úplet goliera a manžetiek, výstrih s dvoma gombíkmi vo farbe, spevňujúci lem výstrihu, značka SLAZENGER

sietotlač, transfer, výšivka

ks	1-7	8+	40+	80+
€	20,957	20,174	19,478	19,000



7530x.B  
biela



7531x.M  
národná modrá



7533x.Z  
zelené jablko



7534x.C  
čierna



7536x.M  
nebeská modrá



7535x.R  
červená



7537x.J  
šedá

3 nové farby

Namiesto „x“ doplňte v kóde požadovanú veľkosť:  
 1=S, 2=M, 3=L, 4=XL, 5=XXL

**ATLANTA CLASSIC SWEATER 260**

klasická značková mikina zo zmesového zvnútra česaného materiálu (50% bavlny a 50% polyesteru) gramáže 260 g/m<sup>2</sup> (pri šedej farbe 9956x.J je zloženie 85% bavlny a 15% viskózy)



sietotlač, transfer, výšivka

biela

ks	1-14	15+	75+	150+
€	14,783	14,261	13,739	13,435

ostatné farby

ks	1-14	15+	75+	150+
€	15,391	14,826	14,304	14,000



9947x.B  
biela



9951x.R  
červená



9954x.M  
národná modrá



9959x.M  
modrá klasik



9956x.J  
šedá



9957x.K  
antracitová



9958x.C  
čierna

Namiesto „x“ doplňte v kóde požadovanú veľkosť:  
 1=S, 2=M, 3=L, 4=XL, 5=XXL, 6=XXXL, 7=XXXXL





### Mikina NATHAN 290

unisexová celozapínacia mikina s kapucňou z príjemného zvnútra česaného materiálu zloženého z 80% bavlny a 20% polyesteru gramáže 290 g/m<sup>2</sup>, kovový zips, dve postranné vrecká, bavlnená podšívka vnútornej časti kapucne, sťahujúca šnúrka vo farbe, manžeta na rukávoch a spodnom okraji

sietťotlač, transfer, výšivka

ks	1-9	10+	50+	100+
€	14,130	13,435	12,826	12,522



8642x.R  
červená



8641x.Z  
zelená



8644x.M  
kráľovská modrá



8643x.M  
námornická modrá



8640x.J  
šedý melír



8645x.C  
čierna

Namiesto „x“ doplňte v kóde požadovanú veľkosť:  
1=S, 2=M, 3=L, 4=XL, 5=XXL



všetko  
novinky

### Mikina SURREY ELEVATE 300

značková klasická mikina z 80% bavlny a 20% polyesteru gramáže 300 g/m<sup>2</sup> česaná vo vnútri pre mäkký a hrejivý pocit s elegantnou "v" vsádkou . 2x2 rebrový úplet vsádky a manžetiek rukávov a spodného lemu. Logo tón v tóne tlačené v spodnej časti chrbta

sietťotlač, transfer, výšivka

ks	1-4	5+	25+	50+
€	34,522	33,217	32,043	31,304



7376x.R  
červená



7377x.M  
svetlomodrá



7378x.M  
modrá



7379x.M  
námornická modrá



7380x.Z  
flašková zelená



7381x.K  
antracitová



7382x.C  
čierna

Namiesto „x“ doplňte v kóde požadovanú veľkosť:  
0=XS, 1=S, 2=M, 3=L, 4=XL, 5=XXL, 6=XXXL

  
ELEVATE



7375x.B  
biela

2 nové farby



**N 9603x.B**  
biela



**N 9598x.M**  
nebeská modrá



**9593x.M**  
svetlomodrá/námornicka



**9588x.Z**  
stredne zelená/námornicka



**9591x.O**  
oranžová/čierna



**9589x.L**  
tmavá khaki



**9597x.R**  
červená/šedá



**9594x.Z**  
zelená/šedá



**9596x.M**  
námornicka modrá



**9595x.M**  
námornicka modrá/šedá



**9600x.J**  
šedá



**9599x.C**  
čierna

Namiesto „x“ doplňte v kóde požadovanú veľkosť:  
1=S, 2=M, 3=L, 4=XL, 5=XXL, 6=XXXL, 7=XXXXL



**NASHVILLE FLEECE JACKET 280**

značková bunda z obojstranne česaného flíšu zo 100% polyesteru gramáže 280 g/m<sup>2</sup> s povrchovou úpravou proti žmolkovaniu, zapínanie na zips, rukávy a spodný okraj sú zakončené pevnou manžetou, dve vonkajšie šikmé vrecká

ks	1-9	10+	50+	100+
€	19,739	19,000	18,304	17,913



**9587x.M**  
modrá klasik/  
čierna

**LADY NASHVILLE FLEECE JACKET 280**

dámska značková bunda z obojstranne česaného flíšu zo 100% polyesteru gramáže 280 g/m<sup>2</sup> s povrchovou úpravou proti žmolkovaniu, zapínanie na zips, rukávy a spodný okraj sú zakončené pevnou manžetou, dve vnútorné šikmé vrecká

výšivka

ks	1-9	10+	50+	100+
€	19,739	19,000	18,304	17,913

3 nové farby



**N 9608x.B**  
biela



**N 9610x.M**  
nebeská modrá



**N 9611x.M**  
svetlomodrá/námornicka



**9602x.O**  
oranžová/čierna



**9605x.Z**  
stredne zelená/námornicka



**9607x.L**  
tmavá khaki



**9601x.R**  
červená/šedá



**9612x.Z**  
zelená/šedá



**9604x.M**  
námornicka modrá



**9613x.M**  
námornicka modrá/šedá



**9614x.J**  
šedá



**9606x.C**  
čierna

Namiesto „x“ doplňte v kóde požadovanú veľkosť:  
1=S, 2=M, 3=L, 4=XL, 5=XXL





**TAOS FLEECE ZIP SWEATER 280**  
 značková obojstranne česaná flísová mikina zo 100% polyesteru s povrchovou úpravou proti žmolkovaniu, gramáž 280 g/m<sup>2</sup>, pružné manžety, v spodnom leme sťahovacia šnúčka

výšivka

ks	1-9	10+	50+	100+
€	19,696	18,957	18,304	17,870



9572x.Z

zelená/námornícka modrá



9575x.R

červená/námornícka modrá



9579x.M

modrá klasik/námornícka modrá



9574x.M

námornícka modrá



9577x.C

čierna

Namiesto „x“ doplňte v kóde požadovanú veľkosť:  
 1=S, 2=M, 3=L, 4=XL, 5=XXL

**Mikroflísová bunda s kontrastnými zipsami 260**  
 značková pánska flísová bunda zo 100% mikroflísku gramáže 260 g/m<sup>2</sup> s úpravou proti žmolkovaniu, stojatý golier, kontrastné zipsy a stehy, sťahovacia šnúčka na spodnom okraji

výšivka

ks	1-19	20+	200+	400+
€	30,435	25,391	22,435	21,913

K dispozícii tiež v dámskom prevedení pod kódmi SW0415\*.

**SOUTH WEST**



7275x.B  
 biela



7276x.M  
 akvamarínová



7278x.R  
 červená



7279x.C  
 čierna

Namiesto „x“ doplňte v kóde požadovanú veľkosť:  
 0=XS, 1=S, 2=M, 3=L, 4=XL, 5=XXL

♂ 7384x.B  
biela



ELEVATE



♀ 7393x.R  
červená



novinka

BROSSARD MICROFLEECE ELEVATE 190, pánska a dámska značková ľahká bunda zo 100% obojstranne česaného PE mikroflísy gramáže 190 g/m<sup>2</sup> s jednostrannou úpravou proti žmolkovaniu, vrecká na zips, elastické kontrastné okraje rukávov i spodného okraja, otvory pre palce na rukávoch, raglánové rukávy, kontrastné logo vyšité v spodnej časti chrbta, dámska má vypasovaný strih s predĺženým zadným dielom

výšivka

ks	1-4	5+	25+	50+
€	37,000	35,652	34,391	33,565

♂ pánsky strih  
♀ dámsky strih



7385x.R  
červená



7388x.Z  
zelené jablko



7386x.M  
modrá



7387x.M  
národná modrá



7389x.K  
antracitová



7390x.C  
čierna

♀



7392x.B  
biela



7396x.Z  
zelené jablko



7394x.M  
modrá



7395x.M  
národná modrá



7397x.K  
antracitová



7398x.C  
čierna

Namiesto „x“ doplňte v kóde požadovanú veľkosť:  
1=S, 2=M, 3=L, 4=XL, 5=XXL, pánska navyše 6=XXXL





**7283x.C**  
čierna

**Flísová vesta WINNIPEG 260**  
unisexová značková flísová vesta zo 100% PE mikroflísu gramáže 260 g/m<sup>2</sup> s úpravou proti žmolkovaniu, 2 bočné vrecká na zips, stojatý golier, sťahovacia šnúrka v spodnom okraji, mierne predĺžený chrbát

novinka

výšivka

ks	1-9	10+	100+	200+
€	20,957	17,522	15,348	15,000

**SOUTH WEST**



**7280x.B**  
biela



**7281x.M**  
národná modrá



**7282x.R**  
červená

Namiesto „x“ doplňte v kóde požadovanú veľkosť:  
0 = XS, 1 = S, 2 = M, 3 = L, 4 = XL, 5 = XXL

**Vesta ORLANDO**

značková vesta zo 100% mikrovlákna z hodvábného polyesteru s PVC potahom a podšívkou z PE taftu s plnením. Predné vrecká na zips, spodný lem je nastaviteľný elastickou sťahujúcou šnúrkou so stoppermi. Vnútorné vrecká, očko na slúchadlá k telefonu. Prístup k tlačovým a výšivkovým plochám zipsom v podšívke



sietotlač, transfer, výšivka

ks	1-7	8+	40+	80+
€	28,391	27,304	26,348	25,739



**9985x.M**  
národná modrá/svetlomodrá



**9986x.C**  
čierna/khaki



**9984x.R**  
červená/národná modrá

Namiesto „x“ doplňte v kóde požadovanú veľkosť:  
1 = S, 2 = M, 3 = L, 4 = XL, 5 = XXL, 6 = XXXL

novinka

**Zimná vesta, pánska a dámska**

fahká, ale veľmi teplá značková zateplená vesta zo 100% polyamidu s podšívkou a výplňou zo 100% polyesteru s odopínacou kapucňou na zips, vetru- a vodoodolná (600 mm vodný stĺpec), 2 predné vrecká so zipsom, náprsné vrecko so zipsom a vnútorné vrecko na mobilný telefón, elastická sťahovacia šnúrka kapucne a spodného okraja, zips na potlač loga na chrbte, dámsky strih je mierne vypasovaný, pánsky strih má predĺžený chrbát

sietotlač, transfer

ks	1-4	5+	25+	50+
€	36,348	34,913	33,609	32,348



FASHION TUNES



**7319x.M**  
**7324x.M**  
národná modrá



**7318x.B**  
**7323x.B**  
prírodná



**7320x.H**  
**7325x.H**  
hnedá



**7321x.C**  
**7326x.C**  
čierna

Namiesto „x“ doplňte v kóde požadovanú veľkosť:  
1 = S, 2 = M, 3 = L, 4 = XL, 5 = XXL, pánska navyč 6 = XXXL



**SOFTSHELL bunda SLAZENGER 360**, pánska a dámska značková športová bunda z moderného technického priedušného a vetru i vode odolného materiálu soft shell z džersejového úpletu gramáže 360 g/m<sup>2</sup> viazaného zo 100% polyesteru a 100% polyesterového mikroflisu, kapučňa so sťahovacou šnúrkou, predné vrecká na zips, spodná časť zakončená sťahovacou šnúrkou, manžety nastaviteľné suchým zipsom. Predĺžený chrbát. Dámsky strih je vypasovaný

sietotlač, transfer, výšivka

ks	1-4	5+	25+	50+
€	67,870	65,391	63,043	61,565

Namiesto „x“ doplňte v kóde požadovanú veľkosť: 1=S, 2=M, 3=L, 4=XL, pánska navyše 5=XXL



7859x.B

7870x.B

slonovinová/šedá



7860x.R

7865x.R

červená/šedá



7858x.J

7871x.J

šedá/čierna

nová farba



7862x.Z

7868x.Z

zelená/šedá



7864x.M

7866x.M

nebeská modrá/šedá



7861x.M

7867x.M

námornícka modrá/šedá



7863x.C

7869x.C

čierna/šedá



**SOFTSHELL bunda CROMWELL 300**, pánska a dámska značková bunda z moderného vodoodolná priedušného softshellového materiálu gramáže 300 g/m<sup>2</sup> viazaného zo 100% polyesteru so 100% polyesterovou sieťovinou. Bunda má reflexné lemovanie, elasticnú zdrhovacou šnúru so stoppermi na spodnom leme a zadnej strane goliera, predné vrecká so zipsom. Manžety sú upraviteľné suchým zipsom. Reflexné lemovanie na prednej a zadnej strane.

sietotlač, transfer, výšivka

ks	1-4	5+	25+	50+
€	44,435	42,783	41,261	40,304

Namiesto „x“ doplňte v kóde požadovanú veľkosť: 1=S, 2=M, 3=L, 4=XL, pánska navyše 5=XXL



7771x.R  
červená



7781x.R  
červená



7774x.Z

7784x.Z

limetková



7772x.M

7782x.M

modrá klasik



7773x.M

7783x.M

námornícka modrá



7775x.C

7785x.C

čierna

♂ pánsky strih  
♀ dámsky strih



7463x.R  
červená



7464x.M  
modrá klasik



7465x.M  
národnica modrá



7466x.C  
čierna

Zateplená softshellová bunda, pánska a dámska spevnená značková softshellová bunda z tkaniny interlock zo 100% PE viazané so 100% PE sieťovinou. Vodoodolná a priedušná bunda, reflexné lemovanie na hrudi a chrbte, predné vrecká so zipsom, vnútorné vrecko, manžetky nastaviteľné suchým zipsom, kapučna pripevnená zipsom s elastickou šnúrkou so stoppermi, prístup k dekoratívnym miestam zipsom v podšívke, dámsky strih je mierne vypasovaný



novinka

sietťotlač, transfer, výšivka

ks	1-4	5+	25+	50+
€	73,783	71,043	68,522	66,913

Namiesto „x“ doplňte v kóde požadovanú veľkosť:  
1=S, 2=M, 3=L, 4=XL, pánska navyč 5=XXL



7458x.R  
červená



7459x.M  
modrá klasik



7460x.M  
národnica modrá



7461x.C  
čierna



**MIAMI JACKET**

značková promo bunda s kapucňou zloženou v golieri, zo 100% polyesteru so striebornou vrstvou vo vnútri, možno zložiť do vrečka z rovnakého materiálu, elastické manžety, šnúrka na stiahnutie v spodnom leme

sieťotlač, transfer

ks	1-19	20+	100+	200+
€	11,087	10,696	10,304	10,043



9551x.B  
biela



9557x.S  
strieborná



9556x.R  
červená



9555x.M  
národnická modrá



9554x.M  
kráľovská modrá



Namiesto „x“ doplňte v kóde požadovanú veľkosť:  
1=S, 2=M, 3=L, 4=XL, 5=XXL



♂ pánsky strih  
♀ dámsky strih

Bunda SYDNEY, pánska a dámska  
značková vodoodolná ľahká bunda s kontrastnou vnútornou podšívkou v pánskom a dámskom strihu zo 100% polyesterového mikrovlákná Dobby s jemným broskyňovým efektom povrchu a PU povlakom s podšívkou zo 100% PE sieťoviny. Skladacia kapucňa ukrytá v golieri. Predné vrecká so zipsom pod chlopňou, vnútorné vrecko na mobilný telefón, manžety so suchým zipsom, nastaviteľný spodný lem elastickou sťahovacou šnůrkou so stoppermi. Podlepené švy. Prístup k potlačovým plochám zipsom na hrudi a na chrbte, pohodlne predĺžený zadný diel, vypasovaný dámsky strih.

sieťotlač, transfer

ks	1-4	5+	25+	50+
€	33,304	32,087	30,957	30,217

Namiesto „x“ doplňte v kóde požadovanú veľkosť:  
1=S, 2=M, 3=L, 4=XL, pánska navyiac 5=XXL



♂  
♀  
7451x.M  
7456x.M  
národnická modrá/biela



7450x.O  
7455x.O  
oranžová/národnická modrá



7452x.C  
7457x.C  
čierna/biela



Powerfleešová bunda s elastanom MANI, pánska a dámska ľahká značková pánska powerfleešová bunda z elastického materiálu s džersej stehom z 91 % polyesteru a 9 % elastanu gramáže 245 g/m<sup>2</sup>, česaná z rubu. 4smerný streč, otvory pre palce na rukávoch, vnútorná búrková chlopňa s ochranou brady, elastický lem manžetiek a spodného okraja bundy, vrecúčko na prehrávač vo vnútri pravého vrecka, reflexná potlač loga na chrbte, vrecká so zipsami, reflexný pásik pozdĺž predného zipsu a na šiji, predĺžený chrbát, dámsky strih je mierne vypasovaný

sietotlač, transfer, výšivka

ks	1-4	5+	25+	50+
€	58,000	55,870	53,870	52,609

novinka



7468x.B  
biela



7469x.R  
červená



7470x.M  
národná modrá



7471x.C  
čierna

+09



7472x.B  
biela



7473x.R  
červená



7474x.M  
národná modrá



7475x.C  
čierna

Namiesto „x“ doplňte v kóde požadovanú veľkosť:  
1=S, 2=M, 3=L, 4=XL, 5=XXL, pánska navyet 6=XXXL



**Parka HASTING**

značková klasická bunda s povrchovou tkaninou zo 100% polyesteru Taslon s vodooodolným nepremokavým A/C povlakom, podšívka zo 100% PE prešivaného taftu a výplňou zo 100% polyesteru. Skladacia kapučňa v golieri so stoppermi, predná chlopňa na suchý zips, dve predné vrecká, manžetky nastaviteľné suchým zipsom, flísová podšívka vo vnútri goliera, vnútorné vrecko a vrecúško na mobil, prístup k potlačovým a výšivkovým plochám zipsom v podšívke



sietotlač, transfer, výšivka

ks	1-4	5+	25+	50+
€	37,000	35,652	34,391	33,565

K dispozícii tiež v dámskom prevedení pod kódmi 31321\*.



7480x.B  
biela



7481x.Y  
žltá



7482x.R  
červená



7483x.O  
oranžová



7484x.M  
nebeská modrá



7485x.M  
modrá klasik



7486x.M  
národná modrá



7487x.Z  
zelené jablko



7488x.C  
čierna

Namiesto „x“ doplňte v kóde požadovanú veľkosť:  
1=S, 2=M, 3=L, 4=XL, 5=XXL

všetko novinky



**Páperová bunda SCOTIA ELEVATE**

exkluzívna ľahká páperová bunda značky Elevate zo 100% nylónu gramáže 115 g/m<sup>2</sup> s výplňou s perím (80 spodné/20 vrchné perie), vrchná tkanina je odolná voči periu, bunda je vodo- a vetruoodolná, priedušná. Vrecká so zipsami, vrecko na rukáve je vhodné na dekoráciu, elastický lem manžetiek a spodného lemu bundy, vnútorná búrková chlopňa s ochranou brady, reflexná potlač loga v spodnej časti chrbta, bundu možno zložiť pri cestovaní na veľmi malý objem

transfer

ks	1-2	3+	15+	30+
€	111,043	106,957	103,130	100,739

K dispozícii tiež v dámskom prevedení pod kódmi 39306\*.



7477x.O  
oranžová



7479x.C  
čierna



7478x.M  
modrá

Namiesto „x“ doplňte v kóde požadovanú veľkosť:  
1=S, 2=M, 3=L, 4=XL, 5=XXL, 6=XXXL



reddot design award  
honourable mention 2013



## ELEVATE

**SOFTSHELL PARKA**, pánska a dámska  
značková softshellová bunda z 95% polyesteru a 5% elastanu  
gramáže 315 g/m<sup>2</sup>, pletenina viazaná zo 100% PE mikroflísy, tkanina  
so 4smerným strečom, 3000mm vodoodolnosť, 800mm priedušnosť.  
Odnímateľná kapučňa, dvojcestný predný zips, tri predné vrecká  
na zips, vnútorné úpletové manžetky rukávov, búrková chlopňa so  
skrytými cvokmi s ochranou brady, náprsné vrecko, otvor na slúchadlá,  
elastická sťahovacia šnúrka v spodnom leme pánskej parky, dámska  
parka má predĺženú dĺžku a v 2/3 chrbta efektívny opasok

sietotlač, transfer, výšivka

ks	1-2	3+	15+	30+
€	111,087	107,000	103,174	100,783



♂ 7288x.C  
čierna



♀ 7289x.C  
čierna

Namiesto „x“ doplňte v kóde požadovanú veľkosť:  
1=S, 2=M, 3=L, 4=XL, 5=XXL, pánska navyac 6=XXXL

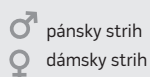

všetko  
novinky

### Bunda 3 v 1 SOUTH WEST

3 značkové bundy v jednej, možno ich nosiť tak každú zvlášť, ako aj spojené  
do jednej teplej bundy pomocou spojovacieho zipsu. Vonkajšia bunda:  
100% 320D nylón taslan shell, odopínacia kapučňa so stoppermi, flisová  
podšívka goliera, 3 vonkajšie vrecká so zipsom, šírka manžiet nastaviteľná  
suchým zipsom, dve vnútorné vrecká, prístup k potlačovým plochám zipsom  
v podšívke. Vnútorná bunda – flis 260 g/m<sup>2</sup> s nylónovou podšívkou, dve  
vonkajšie vrecká, elastické konce rukávov, elastická sťahovacia šnúrka  
v leme spodného okraja, prístup k výšivkovej ploche zipsom v podšívke

sietotlač, transfer, výšivka

ks	1-9	10+	100+	200+
€	119,043	99,696	88,043	86,000

K dispozícii tiež v dámskom prevedení pod kódmi SW0612\*.



7286x.M  
národnica modrá



7287x.C  
čierna



7285x.R  
červená

Namiesto „x“ doplňte v kóde  
požadovanú veľkosť:  
0=XS, 1=S, 2=M, 3=L,  
4=XL, 5=XXL, 6=XXXL



# Čiapky, šály, klobúky, rukavice

## Textilný unisex klobúk

290 x 255 mm

ks	1-99	100+	500+	1000+
€	1,835	1,761	1,691	1,648

4 nové farby



Klobúky na tejto strane sú dodávané bez stuhy, ktorú možno objednať pod kódom 8013x.x



80131.B



80132.Y

## Reklamná stuha ku klobúkom

660 x 27 mm  
netkaná textília  
transfer



80133.R



80134.M

ks	1-99	100+	500+	1000+
€	0,230	0,222	0,213	0,209



80135.M



80136.Z

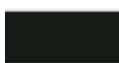

80137.C

spojenie stuhy a jej umiestnenie na klobúk: +0,065 €/ks

## 80121.P

### Dámsky slamený klobúk

ks	1-99	100+	500+	1000+
€	1,896	1,817	1,748	1,704



## 80104.M



### Pirátska šatka

35% bavlna, 65% polyester  
sietotlač, transfer, výšivka

ks	1-199	200+	1000+	2000+
€	1,026	0,987	0,948	0,922



80101.Y



80102.O



80105.C



80103.R



## 80120.P

### Pánsky slamený klobúk

ks	1-99	100+	500+	1000+
€	1,752	1,678	1,613	1,570





novinka

Safari klobúk so šnúrkou

bavlna  
sietotlač, transfer, výšivka

ks	1-49	50+	250+	500+
€	4,017	3,852	3,700	3,604

80143.Z



80144.P



39242.M



39240.B



39243.L



novinka

**ELEVATE**

Šesťdielna čiapka ELEVATE  
z jemného polyesteru  
so sendvičovým šiltom a sieťovinou

100% polyester  
transfer, výšivka

ks	1-19	20+	100+	200+
€	11,739	11,304	10,913	10,652



39241.C



42824.B

Bavlnený klobúk

sietotlač, transfer, výšivka

ks	1-199	200+	1000+	3000+
€	0,861	0,796	0,739	0,691

novinka

Sedempanelová bavlnená čiapka

bavlna  
transfer, výšivka

ks	1-119	120+	600+	1200+
€	1,613	1,543	1,483	1,448



80147.R



80146.O



80149.Z



80148.M





44421.C



44422.R



44423.P



44420.M

**Päťdielna čiapka  
s nízkym profilom  
a sendvičovým šiltom**

bavlna 220 g/m<sup>2</sup>  
transfer, výšivka

ks	1-99	100+	500+	1500+
€	2,017	1,861	1,730	1,613



**Päťdielna basebalová  
čiapka s reflexným lemom**

bavlna  
transfer, výšivka

ks	1-99	100+	500+	1000+
€	1,861	1,791	1,726	1,687



50043.C



50046.0



50044.R



50045.B



50047.M



**44446.Q**

**Šesťdielna bavlnená  
čiapka s nízkym profilom**

bavlna 220 g/m<sup>2</sup>  
transfer, výšivka

ks	1-99	100+	500+	1500+
€	2,170	2,004	1,861	1,735





Šesťdielna bavlnená čiapka  
s koženým šiltom

bavlna 350 g/m<sup>2</sup>  
transfer, výšivka

ks	1-79	80+	400+	800+
€	2,574	2,374	2,204	2,061



44440.M



44441.C



38220.B



38221.O



38222.Y



38223.M



nová  
farba

38233.J



38224.L



38225.M

Päťdielna bavlnená čiapka

bavlna 170 g/m<sup>2</sup>  
transfer, výšivka

ks	1-99	100+	500+	1000+
€	1,587	1,530	1,474	1,439



38226.R



38227.C



38228.Z



38232.M

Tento model čiapok dodávame tiež v detskej veľkosti. Pre objednanie detských čiapok nahradte dvojčíslicie 38xxx.x na začiatku kódu dvojčíslicím 39xxx.x. Cena detských čiapok je totožná s cenou čiapok 38xxx.x na tejto strane, viď tabuľka.





44433.J



44430.M



44432.L



44434.C



44436.Q

Šesťdielna keprová čiapka so sendvičovým šiltom

bavlna 240 g/m<sup>2</sup>  
transfer, výšivka

ks	1-99	100+	500+	1500+
€	2,170	2,004	1,861	1,735



44431.R



44435.Z



38211.C



38212.M

Bavlnená čiapka San Diego

bavlna 186 g/m<sup>2</sup>  
sietotlač, transfer, výšivka

ks	1-79	80+	400+	800+
€	2,448	2,357	2,274	2,222



38214.Z



38213.L



nová farba

38215.J



80169.C

Flísová čiapka so šiltom

flís 250 g/m<sup>2</sup>  
výšivka

novinka

ks	1-79	80+	400+	800+
€	2,491	2,391	2,296	2,235

suchý zips pre nastavenie veľkosti



80168.R



80139.J

Elegantný pánsky šál  
v darčekovej krabičke

**Alexluca**  
Italy

1600 x 210 mm  
bavlna/polyester  
sietotlač (box)

ks	1-19	20+	100+	200+
€	10,957	10,478	10,087	9,826



Zimná čiapka – ušianka

flís/polyester  
sietotlač, transfer, výšivka

ks	1-19	20+	100+	200+
€	12,261	11,826	11,391	11,130



38205.M



38204.L



38240.J  
dámske

Dámske pletené rukavice  
veľkosť S/M

Pánske pletené rukavice  
veľkosť L/XL

transfer

ks	1-39	40+	200+	400+
€	6,130	5,913	5,696	5,565

V týchto rukaviaciach môžete  
ovládať dotykové zariadenia



38242.J  
pánske



38241.C  
dámske

38243.C  
pánske

52010.V

52013.Z



Elegantný jemný šál

viskóza  
1800 x 700 mm  
sietotlač, transfer, výšivka

ks	1-39	40+	200+	400+
€	5,087	4,913	4,739	4,609



52012.M



52014.O

52015.E

52016.L

52017.M



80151.R pánske  
80156.R dámske



80152.M pánske  
80157.M dámske



80150.0 pánske  
80155.0 dámske



80153.C pánske  
80158.C dámske

**Fľisové rukavice**

fľis 200 g/m<sup>2</sup>  
výšivka

ks	1-99	100+	500+	1000+
€	2,013	1,930	1,857	1,809



**Fľisová sada**

polyester 210 g/m<sup>2</sup>  
výšivka, transfer (na vrecko)

ks	1-29	30+	150+	300+
€	6,478	6,261	6,000	5,870



38200.R



38202.C



38201.M



52001.M

52006.M

**Fľisový šál**

1500 x 210 mm  
100% polyester  
výšivka

ks	1-119	120+	600+	1200+
€	1,696	1,635	1,578	1,539



52004.M

52007.0



52002.0

**Fľisová čiapka**

100% polyester  
výšivka

ks	1-129	130+	650+	1300+
€	1,552	1,491	1,439	1,404

# Dáždniky a pršiplášte



30431.B



30434.M

Pršiplášť – pončo v uzatvárateľnom obale rovnakej farby

1220 x 1230 mm  
225 x 200 mm  
sietotlač (na obal)

ks	1-59	60+	300+	600+
€	3,439	3,313	3,196	3,122



50393.M



50394.Y



Pršiplášť s kapucňou veľkosti XL

660 x 860 mm  
sietotlač, transfer

ks	1-49	50+	250+	500+
€	4,065	3,913	3,774	3,687

20164.Z



Transparentné pláštenkové pončo v prívesku s karabínou

Ø 60 mm (obal)  
tampoprint (na obal)

ks	1-199	200+	1000+	2000+
€	1,074	1,035	1,000	0,974



20160.C



20161.M



20162.R



20163.B



Cestovný pršiplášť – pončo

1200 x 1200 mm  
95 x 140 mm (obal)  
ofset

ks	1-399	400+	2000+	4000+
€	0,539	0,517	0,500	0,487



20172.TY



20173.TB



20171.TR



20170.TM





novinka



**Nepremokavý ruksak so všitou bundou do dažďa 2v1**

290 x 405 x 180 mm  
polyester 190T  
jedna univerzálna veľkosť  
sietotlač, transfer

ks	1-7	8+	40+	80+
€	20,957	20,174	19,478	19,000



**Trojdielny skladací dáždník v PVC obale**

Ø 940 mm  
sietotlač, transfer

ks	1-49	50+	250+	500+
€	4,226	4,070	3,926	3,835

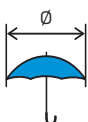

Rozmery dáždnikov sú uvádzané ako približný vnútorný priemer otvoreného dáždnika.



**MICROBRELLA®**

Štvordielny skladací mini dáždník v obale

Ø 850 mm  
sietotlač, transfer

ks	1-19	20+	100+	300+
€	10,391	10,043	9,696	9,348



Dĺžka v zloženom stave je iba 18 cm.  
Obal s pútkom pre pripavenie na opasok či tašku.







 28132.K

**Päťdielny skladací dáždnik s pevným puzdrom**

ø 890 mm  
sietotlač, transfer

ks	1-29	30+	150+	300+
€	8,652	8,304	8,000	7,826



 28131.C



 35557.C

**Trojdielny skladací dáždnik**

ø 970 mm  
sietotlač, transfer

ks	1-49	50+	250+	500+
€	4,057	3,909	3,765	3,678



 35560.B



 35558.M



 35559.R



 35509.V

nová farba



 35512.S



 35511.C



 35513.J



 35510.M

**Trojdielny skladací dáždnik s automatickým otváraním aj zatváraním**

ø 980 mm  
sietotlač, transfer

ks	1-19	20+	100+	200+
€	9,913	9,565	9,217	9,000



 nová farba  
35500.R



 35503.S

**Dvojielny skladací automatický dáždnik**

Ø 1030 mm  
sietotlač, transfer

ks	1-29	30+	150+	300+
€	7,913	7,609	7,348	7,174



 35506.M



 35504.C



**Samsnite®**

61156.C

Značkový skladací dáždnik SAMSONITE

Ø 870 mm  
sietotlač, transfer

ks	1-14	15+	60+	120+
€	18,609	17,348	16,261	15,304



 nová farba  
37992.M

**BALMAIN**  
PARIS

Značkový trojielny skladací dáždnik BALMAIN

Ø 980 mm  
sietotlač, transfer

ks	1-19	20+	100+	200+
€	12,043	11,609	11,174	10,913



 37999.S



 37994.C



 37990.B



novinka

35520.C

Trojdielny skladací automatický dáždnik MARKSMAN

Ø 980 mm  
sieťotlač, transfer

ks	1-9	10+	50+	100+
€	17,261	16,609	16,043	15,652



MARKSMAN

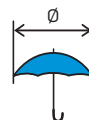

Rozmery dáždnikov sú uvádzané ako približný vnútorný priemer otvoreného dáždnika.



novinka

80391.C

Automatický, vetruodolný dáždnik André Philippe s pogumovanou rukoväťou a sklolaminátovou konštrukciou

Ø 1000 mm  
sieťotlač, transfer

ks	1-19	20+	100+	300+
€	10,043	9,609	9,261	9,000



Dodávaný v obale s logom André Philippe.

**andré philippe**



80390.C

Elegantný automatický skladací dáždnik André Philippe

Ø 995 mm  
sieťotlač, transfer

ks	1-19	20+	100+	300+
€	10,217	9,783	9,391	9,174

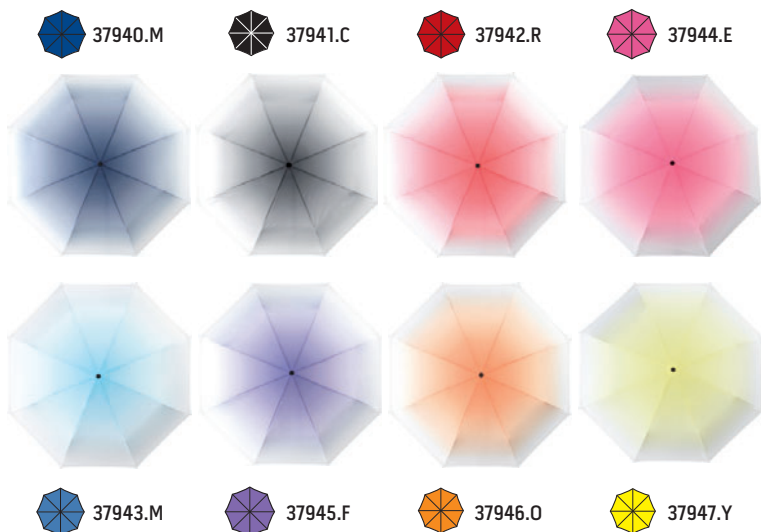



novinka

Dvojielny skladací dáždnik s farbou dostratena

Ø 1000 mm  
sietotlač, transfer

ks	1-19	20+	100+	200+
€	10,783	10,391	10,043	9,783

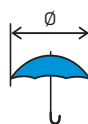

Rozmery dáždnikov sú uvádzané ako približný vnútorný priemer otvoreného dáždnika.



35567.C

Veľký automatický dvojielny skladací dáždnik

Ø 1050 mm  
sietotlač, transfer

ks	1-29	30+	150+	300+
€	7,913	7,609	7,348	7,174



35568.M

91072.J



Reflexné prvky 3M Scotchlite™ na okrajoch dáždnika.



Trojielny automatický skladací dáždnik s 9x LED baterkou v rukoväti

Ø 980 mm  
sietotlač, transfer

ks	1-9	10+	50+	150+
€	17,304	16,609	15,957	15,391



Safebrella®



91070.R



91071.M



91073.C



28133.R

novinka

Automatický dáždnik s drevenou rukoväťou

Ø 1000 mm  
sietotlač, transfer

ks	1-39	40+	200+	400+
€	4,826	4,652	4,478	4,348



28134.Z



28135.M



35550.M



35549.Y

3 nové farby



35552.0



Automatický dáždnik s tvarovanou drevenou rukoväťou

Ø 1020 mm  
sietotlač, transfer

ks	1-49	50+	250+	500+
€	4,165	4,013	3,870	3,778



35534.B



35541.C



35544.R



35538.Z



35542.M



38071.C

Polyesterový dáždnik s konštrukciou z hliníka

Ø 1040 mm  
sietotlač, transfer

ks	1-29	30+	150+	300+
€	8,130	7,826	7,565	7,391



38070.M



38072.S



29078.R



29079.B

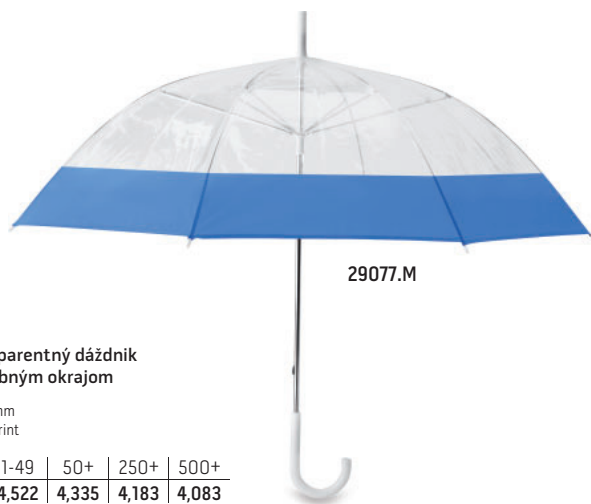

29077.M



Tlač je možná iba na plastovú rúčku dáždnika.

Transparentný dáždnik  
s farebným okrajom

Ø 980 mm  
tamprint

ks	1-49	50+	250+	500+
€	4,522	4,335	4,183	4,083



50786.V



50787.C



50788.M



50790.Z

Automatický dáždnik

Ø 1 040 mm  
sietotlač, transfer

ks	1-39	40+	200+	400+
€	5,826	5,609	5,435	5,304



50613.M

Klasický dáždnik

Ø 1050 mm  
sietotlač, transfer

ks	1-39	40+	200+	400+
€	5,217	5,000	4,826	4,739



50611.V



50612.C



50614.R



50615.B



50617.Z



50616.Y

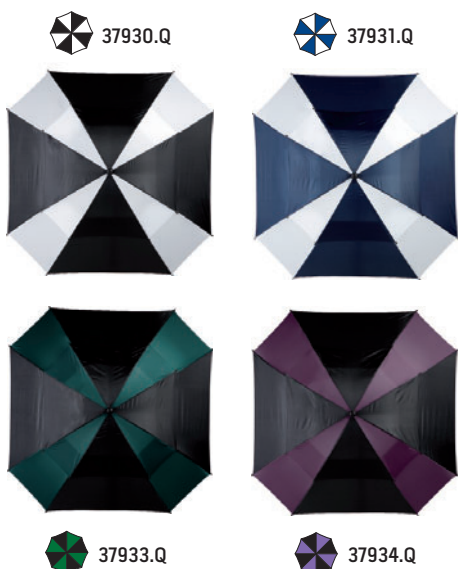
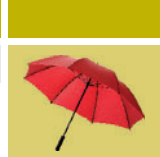

novinka

Dvojplášťový štvorcový dáždnik s rebrami zo sklenených vlákien

Ø 1060 mm  
sieťotlač, transfer

ks	1-9	10+	50+	100+
€	16,043	15,435	14,870	14,522



37932.Q



nová farba

35598.M



Automatický dáždnik z hodvábného polyesteru s logom SLAZENGER

Ø 980 mm  
sieťotlač, transfer

ks	1-9	20+	100+	200+
€	12,304	11,870	11,435	11,174



nová farba

35591.R



35586.C

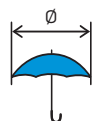

Rozmery dáždnikov sú uvádzané ako približný vnútorný priemer otvoreného dáždnika.



37993.H

Elegantný dáždnik BALMAIN z hodvábného polyesteru

Ø 1030 mm  
sieťotlač, transfer

ks	1-9	10+	50+	100+
€	16,043	15,435	14,870	14,522



37991.C

BALMAIN  
PARIS



37977.S



37978.M



37976.B



 80382.C

novinka

Šestnásťpanelový elegantný dáždnik André Philippe

Ø 1100 mm  
sietotlač, transfer

ks	1-19	20+	100+	300+
€	10,261	9,870	9,478	9,217



 80380.M

 **andré philippe**



Dodávaný v obale s logom André Philippe.



 80381.Z

2 nové farby



 35599.M

Veľký golfový dáždnik

Ø 1300 mm  
sietotlač, transfer

ks	1-39	40+	200+	400+
€	5,870	5,652	5,478	5,348



 35569.Z



 35518.Q

 35521.Q

 35514.C

 35515.J

 35516.B

 35524.M

 35525.R



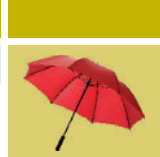

 38251.M

 38250.C



 38255.Z



Veľký golfový dáždnik SLAZENGER  
s mäkkou EVA rúčkou

Ø 1300 mm  
sieťotlač, transfer

ks	1-19	20+	100+	200+
€	11,087	10,696	10,304	10,043



 38253.B

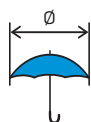

Rozmery dáždnikov sú uvádzané ako približný  
vnútorný priemer otvoreného dáždnika.



Veľký golfový dáždnik odolný  
voči búrke s mäkkou EVA rúčkou  
a rebrami zo sklenených vlákien

Ø 1300 mm  
sieťotlač, transfer

ks	1-29	30+	150+	300+
€	8,609	8,304	8,000	7,826



nová  
farba  38288.R



 38281.Z



 38283.C



 38285.B



 38286.S



 38287.H



 38282.M



# Tašky, ruksaky, cestovná batožina



Papierová taška s plochým držadlom, biela – kraft papier

sietotlač

od 0,<sup>171</sup>

91371.B  
440 x 140 x 500 mm

913H1.B  
320 x 130 x 425 mm

91341.B  
230 x 100 x 320 mm

91381.B  
180 x 80 x 250 mm

Papierová taška s plochým držadlom – sulfátový papier

sietotlač

od 0,<sup>171</sup>

913J2.P  
320 x 130 x 425 mm

91372.P  
440 x 140 x 500 mm

91382.P  
180 x 80 x 250 mm

91342.P  
230 x 100 x 320 mm



Papierová taška s plochým držadlom, natural – recyklovaný papier

sietotlač

od 0,<sup>159</sup>



91351.P  
180 x 80 x 250 mm

91352.P  
230 x 100 x 320 mm

91353.P  
260 x 110 x 380 mm

91354.P  
320 x 130 x 425 mm

91355.P  
440 x 140 x 500 mm

## Cenník papierových tašiek s plochým držadlom

kód	cena	kód	cena
91371.B	0,478	91382.P	0,171
913H1.B	0,322	91351.P	0,159
91341.B	0,237	91352.P	0,200
91381.B	0,171	91353.P	0,249
91372.P	0,478	91354.P	0,298
913J2.P	0,322	91355.P	0,445
91342.P	0,237		

## Cenník papierových tašiek s plochým držadlom

kód	9130x.x	9131x.x	9132x.x	9133x.x
cena	0,216	0,282	0,347	0,420



91301.R  
180 x 80 x 250 mm

91311.R  
230 x 100 x 320 mm

91321.R  
260 x 110 x 380 mm

91331.R  
320 x 130 x 425 mm

Papierová taška s plochým držadlom – sulfátový papier

sietotlač

od 0,<sup>216</sup>



91305.Z  
180 x 80 x 250 mm

91315.Z  
230 x 100 x 320 mm

91325.Z  
260 x 110 x 380 mm

91335.Z  
320 x 130 x 425 mm



91302.M  
180 x 80 x 250 mm

91312.M  
230 x 100 x 320 mm

91322.M  
260 x 110 x 380 mm

91332.M  
320 x 130 x 425 mm



91304.E  
180 x 80 x 250 mm

91314.E  
230 x 100 x 320 mm

91324.E  
260 x 110 x 380 mm

91334.E  
320 x 130 x 425 mm



91303.O  
180 x 80 x 250 mm

91313.O  
230 x 100 x 320 mm

91323.O  
260 x 110 x 380 mm

91333.O  
320 x 130 x 425 mm



91316.Z  
230 x 100 x 320 mm

91326.Z  
260 x 110 x 380 mm

91336.Z  
320 x 130 x 425 mm

Kompletný sortiment papierových tašiek a cenník on-line je na našich www stránkach alebo na dopyt.



Papierová taška so skrútenou šnúrkou, farebná – sulfátový/kraft\* papier

sieťotlač

od 0,<sup>253</sup>

Cenník papierových tašiek so skrútenou šnúrkou							
kód	9120x.x	9121x.x	9122x.x	9126x.x	9127x.x	9128x.x	9129x.x
cena	0,261	0,322	0,437	0,253	0,371	0,437	0,580

Kompletný sortiment papierových tašiek a cenník on-line je na našich www stránkach alebo na dopyt.



91202.M  
180 x 80 x 250 mm

91212.M  
230 x 100 x 320 mm

91222.M  
320 x 130 x 425 mm



91201.C  
180 x 80 x 250 mm

91211.C  
230 x 100 x 320 mm

91221.C  
320 x 130 x 425 mm



91262.R  
180 x 80 x 200 mm

91272.R  
320 x 130 x 280 mm

91282.R  
320 x 130 x 420 mm



91266.Z  
180 x 80 x 200 mm

91276.Z  
320 x 130 x 280 mm

91286.Z  
320 x 130 x 420 mm



91203.V  
180 x 80 x 250 mm

91213.V  
230 x 100 x 320 mm

91223.V  
320 x 130 x 425 mm



91263.M  
180 x 80 x 200 mm

91273.M  
320 x 130 x 280 mm

91283.M  
320 x 130 x 420 mm



91264.O  
180 x 80 x 200 mm

91274.O  
320 x 130 x 280 mm

91284.O  
320 x 130 x 420 mm



91205.E  
180 x 80 x 200 mm

91275.E  
320 x 130 x 280 mm

91285.E  
320 x 130 x 420 mm



91207.Y  
180 x 80 x 200 mm

91277.Y  
320 x 130 x 280 mm

91287.Y  
320 x 130 x 420 mm



91219.S  
180 x 80 x 250 mm

91289.S  
230 x 100 x 320 mm

91299.S  
320 x 130 x 425 mm

nový rozmer

911R2.P

540 x 140 x 500 mm

91132.P

320 x 130 x 425 mm

nový rozmer

911F2.P

260 x 110 x 345 mm

91142.P

230 x 100 x 320 mm

91182.P

180 x 80 x 250 mm

911R1.B

540 x 140 x 500 mm

91131.B

320 x 130 x 425 mm

911F1.B

260 x 110 x 345 mm

91141.B

230 x 100 x 320 mm

91181.B

180 x 80 x 250 mm

Papierová taška so skrútenou šnúrkou, natural – sulfátový papier

sieťotlač

od 0,<sup>220</sup>

Cenník papierových tašiek so skrútenou šnúrkou			
	kód	cena	
N	911R2.P	911R1.B	0,608
	91132.P	91131.B	0,339
N	911F2.P	911F1.B	0,273
	91142.P	91141.B	0,269
	91182.P	91181.B	0,220

Papierová taška so skrútenou šnúrkou, biela – kraft papier

sieťotlač

od 0,<sup>220</sup>



Papierová taška so skrútenou šnúrkou,  
natural – recyklovaný papier

sietotlač

od 0,<sup>200</sup>



Cenník papierových tašiek so skrútenou šnúrkou, natural

kód	91180.P	91140.P	91150.P	91160.P	91170.P
rozmer	180 x 80 x 250 mm	230 x 100 x 320 mm	320 x 130 x 425 mm	320 x 190 x 340 mm	540 x 140 x 500 mm
cena	0,200	0,241	0,339	0,347	0,551



Cenník modrých papierových tašiek so skrútenou šnúrkou

kód	91133.M	911E3.M	91153.M	91173.M
cena	0,641	0,714	1,016	1,294

Papierová taška so skrútenou šnúrkou,  
modrá – sulfátový papier

sietotlač

od 0,<sup>641</sup>

91173.M

450 x 145 x 480 mm

91153.M

360 x 120 x 400 mm

911E3.M

250 x 110 x 410 mm

91133.M

200 x 100 x 280 mm

Cenník modrých papierových tašiek s textilnou šnúrkou

kód	91583.M	915C3.M	915S3.M
cena	0,837	0,935	2,037

Papierová taška s textilnou šnúrkou,  
modrá – sulfátový papier

sietotlač

od 0,<sup>837</sup>



91583.M

160 x 80 x 240 mm

915C3.M

250 x 110 x 310 mm

915S3.M

550 x 150 x 480 mm



915P1.B

540 x 140 x 445 mm

915K1.B

380 x 130 x 310 mm

91531.B

220 x 100 x 275 mm

91581.B

160 x 80 x 250 mm

Papierová taška s textilnou šnúrkou,  
biela – sulfátový papier

sietotlač

od 0,<sup>747</sup>

Cenník bielych papierových tašiek s textilnou šnúrkou

kód	91581.B	91531.B	915K1.B	915P1.B
cena	0,747	0,796	1,082	1,424



Papierová krabica  
na 1 fľašu vína

80 x 80 x 345 mm  
sietotlač

**0,641**

91812.P

91813.M

91814.B



Papierová krabica  
na 2 fľaše vína

165 x 82 x 345 mm  
sietotlač

**0,731**

91822.P

91823.M

91824.B



Papierová taška  
so skrútenou šnúrkou –  
sulfátový papier

150 x 80 x 400 mm  
sietotlač

**0,355**

91124.C

91126.Z

91127.V

91123.M



Papierová taška  
so skrútenou šnúrkou –  
sulfátový papier

150 x 80 x 400 mm  
sietotlač

**0,282**

91121.B

91122.P

Papierová taška s textilnou  
šnúrkou – sulfátový papier

120 x 90 x 400 mm  
sietotlač

**0,796**



91512.P

91511.B



91831.T  
HDPE taška  
na 1 fľašu vína

110 x 100 x 430 mm  
sietotlač

**0,478**

Papierová taška s textilnou  
šnúrkou – sulfátový papier

120 x 90 x 400 mm  
sietotlač

**0,878**



91517.V

91516.Z

91513.M



52138.Z



52136.M



52135.C



52137.E

**Skladacia cestovná taška s predným vreckom**

novinka

400 x 340 x 120 mm  
polyester 210D  
sietotlač, transfer

ks	1-49	50+	250+	500+
€	4,048	3,896	3,757	3,670



42834.Z



**Nylónová skladacia nákupná taška**

400 x 470 mm  
sietotlač, transfer

ks	1-149	150+	600+	1500+
€	1,622	1,496	1,391	1,300

**Skladacia nákupná taška SRDIEČKO**

370 x 410 mm  
nylón 190T  
sietotlač, transfer

ks	1-99	100+	500+	1000+
€	1,882	1,767	1,702	1,661



16072.R



16071.C



16073.M



42833.R



42832.M



42825.M

**Skladacia nákupná taška z netkanej textilie**

400 x 470 mm  
sietotlač, transfer

ks	1-299	300+	1500+	3000+
€	0,778	0,726	0,691	0,665



42827.Y



42828.Z



42826.R



30533.R

30532.M

**Bavlnená taška s dlhými ušami**

380 x 420 mm  
bavlna 100 g/m<sup>2</sup>  
sieťotlač, transfer

ks	1-199	200+	1000+	2000+
€	1,235	1,187	1,148	1,122



30531.C

30535.Z

30537.B

30538.Y



42820.P

**Bavlnená taška NATURE**

380 x 420 mm  
bavlna 100 g/m<sup>2</sup>  
sieťotlač, transfer

ks	1-299	300+	1000+	3000+
€	0,865	0,830	0,796	0,778



42821.P

**Bavlnená taška NATURE**

380 x 420 mm  
bavlna 100 g/m<sup>2</sup>  
sieťotlač, transfer

ks	1-299	300+	1000+	3000+
€	1,039	0,996	0,970	0,935



20054.P

**Jutová nákupná taška s bavlnenými ušami**

380 x 420 mm  
transfer

ks	1-99	100+	500+	1000+
€	1,809	1,743	1,683	1,643

**Taška z netkanej textílie**

340 x 375 x 65 mm  
sieťotlač, transfer

ks	1-199	200+	1000+	2000+
€	0,800	0,770	0,743	0,726



52105.L

52104.O

52102.M

52103.R

52101.C



52100.H



**Skladací nákupný košík s hliníkovým rámom a vreckom na peniaze**

450 x 230 x 270 mm  
polyester 600D  
sietotlač

ks	1-9	10+	50+	150+
€	16,043	15,478	14,870	14,348

Celoplošná tlač košíka je možná od 1 500 ks. Cena na vyžiadanie.



**30180.Y**  
**Reflexný nylonový ruksak**

340 x 420 mm  
nylón 210D  
sietotlač, transfer

novinka

ks	1-99	100+	500+	1000+
€	1,939	1,870	1,800	1,761



**Jednoduchý polyesterový ruksak**

330 x 440 mm  
polyester 210D  
sietotlač, transfer, výšivka

ks	1-199	200+	1000+	2000+
€	1,035	1,000	0,961	0,939



**Nákupná taška s držadlami z netkanej textilie**

340 x 440 mm  
sietotlač, transfer

ks	1-399	400+	2000+	4000+
€	0,491	0,470	0,452	0,439



80306.Z

80301.B

80302.Y

80304.R

80307.C

80303.O

80305.M





30478.M



30479.R



Nákupná taška z netkanej textílie s farebnými doplnkami

270 x 350 x 140 mm  
netkaná textília 80 g/m<sup>2</sup>  
sietotlač, transfer

ks	1-99	100+	500+	1000+
€	1,365	1,317	1,270	1,239



30476.C

52117.M



Veľká dvojvrstvomá nákupná taška z netkanej textílie

345 x 330 x 200 mm  
netkaná textília 80 g/m<sup>2</sup>  
sietotlač, transfer

ks	1-59	60+	300+	600+
€	3,165	3,048	2,939	2,870



52120.R

všetko novinky

Taška cez rameno z netkanej textílie

400 x 355 x 130 mm  
netkaná textília 80 g/m<sup>2</sup>  
sietotlač, transfer

ks	1-149	150+	750+	1500+
€	1,339	1,287	1,243	1,213



52125.E



52128.Z



52124.O



52123.M



52114.0



Nákupná taška z netkanej textílie

400 x 400 mm  
netkaná textília 80 g/m<sup>2</sup>  
sietotlač, transfer

ks	1-299	300+	1500+	3000+
€	0,652	0,630	0,604	0,591

52109.R



52110.B



52108.C



52113.Z



52115.M



52116.L



**44731.M**  
Triangl ruksak DONG

310 x 440 x 130 mm  
polyester  
sietotlač, transfer

ks	1-79	80+	400+	1200+
€	2,574	2,374	2,204	2,061



**44736.M**  
Polyesterový ruksak DING

290 x 380 x 140 mm  
sietotlač, transfer

ks	1-59	60+	300+	900+
€	3,470	3,200	2,974	2,774

**30166.M**



**Bohato vybavený ruksak s prípravou na slúchadlá**

340 x 450 x 180 mm  
polyester 600D  
sietotlač, transfer

ks	1-14	15+	75+	150+
€	13,565	13,043	12,609	12,304



**30163.M**



**30164.R**

**Trendy ruksak s prípravou na slúchadlá**

330 x 480 x 170 mm  
polyester 600D  
sietotlač, transfer

ks	1-19	20+	100+	200+
€	10,174	9,826	9,478	9,217

**37206.Z**



**37207.C**



**37204.M**



**37203.M**

**37205.O**



**37201.R**





37224.C



37227.B

**Kombinovaný ruksak s bočnými vreckami so zipsom**

novinka

405 x 440 x 165 mm  
polyester 600D  
sietotlač, transfer

ks	1-19	20+	100+	200+
€	11,087	10,696	10,304	10,043



37225.M



37226.R



37228.M



37229.J



30542.C



30543.R



30541.M

**Polyesterový ruksak s vnútorným organizérom**

290 x 420 x 180 mm  
polyester 600D / PVC  
sietotlač, transfer

ks	1-29	30+	150+	300+
€	7,391	7,130	6,870	6,696



20329.O



20327.M



20328.R

**Moderný ruksak s polstrovanými popruhmi**

290 x 460 x 160 mm  
polyester 600D  
sietotlač, transfer

ks	1-14	15+	75+	150+
€	11,348	10,913	10,522	10,304



37215.Y

**Jednofarebný trendy ruksak**

350 x 450 x 170 mm  
polyester 600D  
sietotlač, transfer, výšivka

ks	1-29	30+	150+	300+
€	6,652	6,391	6,174	6,043



37209.B



37210.M



37211.C



37212.M



37213.R



37214.O



37216.M



37217.L



37218.Z



37219.Z



30480.C

novinka

Malý obal na pas a kreditné karty s ochrannou fóliou

105 x 140 x 10 mm  
tampoprint, sietotlač

ks	1-9	10+	50+	100+
€	16,043	15,435	14,870	14,522



ochranná metalická podšívka  
ochráni čip na kreditných kartách  
pred rádiovými vlnami

30484.C

Veľký obal na pas a kreditné karty s ochrannou fóliou

novinka

115 x 220 x 15 mm  
tampoprint, sietotlač

ks	1-7	8+	40+	80+
€	23,435	22,565	21,783	21,261

MARKS  AN



50470.C

Polyesterová taška cez rameno

175 x 225 x 65 mm  
polyester 6000  
sietotlač, transfer

ks	1-49	50+	250+	500+
€	3,800	3,661	3,530	3,448

80196.C

Taška na sedadlo auta s nastaviteľným popruhom

novinka

241 x 228 x 102 mm  
polyester  
sietotlač, transfer

ks	1-299	300+	1500+	3000+
€	0,626	0,600	0,574	0,561



44714.C

Polyesterová ľadvinka s vreckom na doklady

350 x 150 x 70 mm  
sietotlač, transfer

ks	1-99	100+	500+	1000+
€	2,013	1,861	1,726	1,613

Cestovná taštička/ľadvinka

150 x 180 x 70 mm  
sietotlač, transfer

ks	1-59	60+	300+	600+
€	3,448	3,183	2,952	2,757



44720.M



44721.L



**35172.C**

Mincovník s nerezovým držadlom a zabudovaným pásmom

75 x 108 mm  
tampoprint

ks	1-59	60+	300+	600+
€	3,239	3,122	3,009	2,939

Táto závesná váha odváži Vašu batožinu až do 23 kg.



**52106.S**

Digitálna váha na batožinu

novinka

105 x 37 x 30 mm  
popruh 148 x 20 mm  
tampoprint

ks	1-29	30+	150+	300+
€	6,870	6,609	6,391	6,217



maximálna hmotnosť batožiny 40 kg



**30470.C**

Taška na obuv s pútkom

135 x 345 x 146 mm  
nylón 70D  
sietotlač, transfer

ks	1-59	60+	300+	600+
€	3,683	3,548	3,417	3,339

**42830.C**

Nylónový obal na obleky

600 x 1000 x 50 mm  
sietotlač, transfer

ks	1-49	50+	200+	500+
€	3,804	3,513	3,261	3,043



**51436.J**

Cestovná sada 3v1

170 x 100 mm (obal)  
sietotlač, transfer

ks	1-79	80+	400+	800+
€	2,513	2,422	2,335	2,278

nafukovací vankúšik,  
maska na oči a ušné upchávky



**35170.M**



**Nafukovací golier**

395 x 280 x 100 mm (vankúšik)  
180 x 110 mm (obal)  
sietotlač, transfer

ks	1-99	100+	500+	1000+
€	1,630	1,570	1,513	1,478



**35171.J**



34131.M

**Cestovná taška s dvomi postrannými vreckami**

560 x 320 x 320 mm  
polyester 600D/300D  
sietotlač, transfer

ks	1-9	10+	50+	100+
€	16,000	15,391	14,826	14,478



34132.R

34133.M

34130.C



20435.M



20436.R



20437.Y

**Cestovná taška s vreckom na drobnosti**

580 x 350 x 300 mm  
polyester 600D  
sietotlač, transfer

ks	1-19	20+	100+	200+
€	11,261	10,826	10,435	10,217



20413.H

**Elegantná cestovná taška z mikrovlákná**

675 x 380 x 170 mm  
sietotlač, transfer

ks	1-19	20+	100+	200+
€	10,130	9,783	9,435	9,217



20414.C



20415.M



20416.R



37220.C

Veľká cestovná taška  
Vancouver na kolieskach

novinka

620 x 305 x 305 mm  
polyester 600D  
sieťotlač, transfer

ks	1-7	8+	40+	80+
€	29,609	28,522	27,478	26,870

VANCOUVER  LINE



37222.C

Veľká cestovná taška  
Vancouver

560 x 360 x 270 mm  
polyester 600D  
sieťotlač, transfer

ks	1-19	20+	100+	200+
€	11,739	11,304	10,913	10,652



37221.C

Extra veľká cestovná taška  
Vancouver

740 x 380 x 340 mm  
polyester 600D  
sieťotlač, transfer

ks	1-9	10+	50+	100+
€	18,435	17,783	17,130	16,739



37223.C

Cestovná taška na kolieskach SLAZENGER  
s dvomi samostatnými oddielmi

670 x 420 x 320 mm  
polyester 600D  
sieťotlač, transfer

ks	1-4	5+	25+	50+
€	74,000	71,261	68,739	67,130



52107.C

Klasická cestovná taška

novinka

450 x 360 x 210 mm  
vysoko kvalitné PVC  
sieťotlač

ks	1-14	15+	75+	150+
€	12,957	12,478	12,043	11,739





20434.Z



20431.M



20432.R

**Lahká športová taška**

450 x 220 x 200 mm  
polyester 210D  
sietotlač, transfer

ks	1-39	40+	200+	400+
€	5,435	5,261	5,043	4,957



44713.C

**Športová polyesterová taška**

590 x 300 x 240 mm  
sietotlač, transfer

ks	1-29	30+	150+	300+
€	8,652	8,043	7,739	7,348

44750.C

**Polyesterová taška s vreckami**

560 x 330 x 265 mm  
polyester 600D  
sietotlač, transfer

ks	1-14	15+	75+	150+
€	14,739	14,174	13,696	13,348



20492.R



**Športová viacúčelová taška s oddielom na topánky**

460 x 250 x 260 mm  
polyester 600D  
sietotlač, transfer

ks	1-14	15+	75+	150+
€	12,435	12,000	11,565	11,304



20491.M





30453.M

Prešívaná športová taška  
SLAZENGER

500 x 290 x 290 mm  
polyester ripstop 600D/300D  
sietotlač, transfer

ks	1-9	10+	50+	100+
€	19,739	19,000	18,304	17,913



nová  
farba

30450.R



30452.C



30451.M

20495.R



Skladacia športová taška  
so sieťovaným vreckom

470 x 280 x 240 mm /  
250 x 280 x 25 mm (zložená)  
polyester 600D  
sietotlač, transfer

ks	1-19	20+	100+	200+
€	10,043	9,652	9,304	9,087

20494.M



30524.R



Polyesterová športová taška

440 x 260 x 220 mm  
polyester 600D + PVC  
sietotlač, transfer

ks	1-29	30+	150+	300+
€	6,478	6,261	6,000	5,870



30523.C



30525.M



# Kongresové tašky a aktovky

## Konferenčná taška na 15,4" notebook s vreckami na dokumenty

370 x 300 x 55 mm  
nylon 420D/mikrovlákno  
sietotlač, transfer

ks	1-19	20+	100+	200+
€	12,261	11,826	11,391	11,130



32151.M



32150.C

32141.M



32142.C

32147.M



32148.M

32143.R



32144.Z

32145.O



32146.P

## Polyesterová taška KONGRES

420 x 330 x 115 mm  
polyester 600D  
sietotlač, transfer

ks	1-29	30+	150+	300+
€	6,783	6,522	6,304	6,130



32149.J



30351.M



30352.Z



30353.M



30356.R

## Konferenčná taška

385 x 285 x 100 mm  
polyester 600D  
sietotlač, transfer

ks	1-39	40+	200+	400+
€	5,609	5,435	5,217	5,087



30360.C



50803.M



50802.O



50801.J



50800.R

**Moderná konferenčná taška  
s dvomi pásičkami**

novinka

 315 x 260 x 80 mm  
 polyester 600D/PVC  
 sieťotlač, transfer

ks	1-39	40+	200+	400+
€	4,696	4,522	4,391	4,278



50865.R



50866.Z

**Polyesterová taška na dokumenty  
s predným vreckom**

 415 x 300 x 80 mm  
 polyester 600D  
 sieťotlač, transfer

ks	1-39	40+	200+	400+
€	5,696	5,478	5,304	5,174



50864.M

32131.C



32132.R

**Konferenčná taška  
z netkanej textílie**

 360 x 300 x 80 mm  
 netkaný polypropylen 150 g/m<sup>2</sup>  
 sieťotlač, transfer

ks	1-69	70+	350+	700+
€	2,757	2,652	2,561	2,500



32133.M



32135.M



32136.B

32134.Z





**Polyesterová konferenčná taška s vreckom na mobil**

novinka

400 x 320 x 100 mm  
polyester 6000  
sietotlač, transfer, výšivka

ks	1-19	20+	100+	200+
€	10,609	10,217	9,870	9,652

50895.C



50897.R



50896.M

32160.C



32161.M



**Polyesterová konferenčná taška s jedným uchom**

390 x 270 x 35 mm  
polyester 6000  
sietotlač, transfer

ks	1-99	100+	500+	1000+
€	1,787	1,722	1,657	1,622



32162.Z



32165.R



32164.M



32163.B

44707.C



**Polyesterová konferenčná taška**

355 x 240 x 40 mm  
polyester 6000  
sietotlač, transfer

ks	1-119	120+	600+	1200+
€	1,587	1,465	1,361	1,270



44704.C

**Nylónový obal na dokumenty**

360 x 258 x 5 mm  
sietotlač, transfer

ks	1-199	200+	800+	1600+
€	1,457	1,343	1,248	1,165



44708.M



50806.M

novinka

**Rozpínacia konferenčná taška  
z krčeného nylónu**

380 x 300 x 120 mm  
krčený nylón  
sietotlač, transfer, výšivka

ks	1-14	15+	75+	150+
€	14,609	14,043	13,565	13,217



50807.R

50877.C

**Čierna polyesterová taška  
na dokumenty s vreckami**

430 x 320 mm  
polyester 600D  
sietotlač, transfer

ks	1-19	20+	100+	200+
€	9,304	8,957	8,609	8,435



44710.C

44709.M

**Nylónová taška**

380 x 280 x 70 mm  
sietotlač, transfer

ks	1-49	50+	200+	400+
€	3,848	3,674	3,578	3,474



ks	1-79	80+	400+	1200+
€	2,574	2,457	2,378	2,283

**Polyesterová  
konferenčná taška**

380 x 310 x 90 mm  
sietotlač, transfer

44705.C



44706.M

44717.M

**Polyesterová konferenčná taška**

375 x 305 x 80 mm  
sietotlač, transfer

ks	1-99	100+	400+	1200+
€	2,148	1,983	1,843	1,717



**16076.C****Spisovka A4 s kalkulačkou, na zips**

320 x 243 x 25 mm  
 nylon/umelá koža  
 tampoprint, laserový popis, sieťotlač

ks	1-9	10+	50+	100+
€	18,898	17,714	17,102	16,694



v obale z netkanej textílie

**50873.C****Mapa A4 s kalkulačkou a blokom**

265 x 345 x 45 mm  
 umelá koža  
 tampoprint, laserový popis

ks	1-9	10+	50+	100+
€	16,043	15,435	14,913	14,565

**50874.C****Mapa A4 s kalkulačkou a blokom**

240 x 320 x 18 mm  
 umelá koža  
 tampoprint, laserový popis

ks	1-19	20+	100+	200+
€	9,957	9,565	9,261	9,043

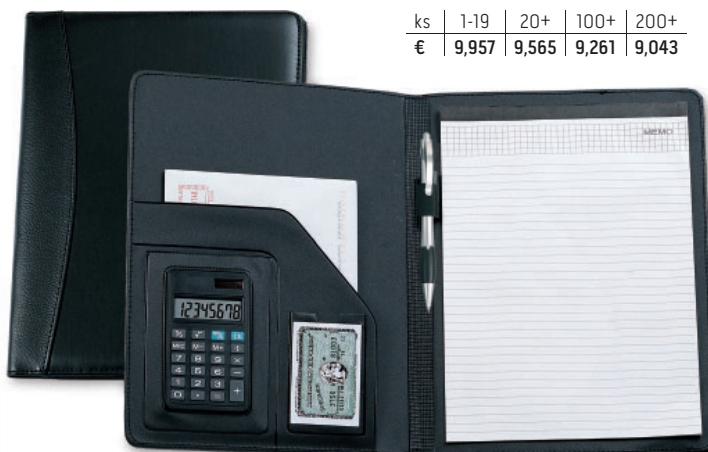
**44722.C****Mapa A4 s kalkulačkou**

250 x 320 x 15 mm  
 polyester  
 sieťotlač, transfer

ks	1-99	100+	300+	1000+
€	3,022	2,883	2,674	2,578





novinka

**38084.C****Spisovka A5 s blokom**175 x 230 x 15 mm  
tampoprint, sieťotlač, laserový popis

ks	1-29	30+	150+	300+
€	7,652	7,348	7,087	6,957

**80191.C****Malý diár formátu A6  
s nekonečným kalendárom**105 x 150 x 25 mm  
razba, tampoprint

ks	1-29	30+	150+	300+
€	6,739	6,478	6,217	6,043

obal z elegantnej umelej kože

**80192.C****Veľký diár formátu A5  
s nekonečným kalendárom**180 x 235 x 30 mm  
razba, tampoprint

ks	1-19	20+	100+	200+
€	10,478	10,043	9,652	9,391

obal z elegantnej umelej kože

**16075.C****Portfólio A4 Classico so  
zapínaním na zips a magnet**250 x 320 x 20 mm  
umelá koža  
tampoprint, laserový popis, sieťotlač

ks	1-7	8+	40+	80+
€	22,082	20,735	19,959	19,510

- vrátane bloku a kalkulačky
- v obale z netkanej textilie





**16188.C**

Spisovka so zipsom  
a puzdrom na iPad New Age

novinka

233 x 293 x 35 mm  
204 x 244 x 17 mm (puzdro na iPad)  
umelá koža  
tampoprint, sietotlač, razba

ks	1-7	8+	40+	80+
€	25,510	23,959	23,102	22,531



vyberateľné puzdro na iPad,  
pero nie je súčasťou



**38083.C**

Obal na iPad s nastaviteľným sklonom

novinka

205 x 250 x 20 mm  
umelá koža  
tampoprint, sietotlač, razba

ks	1-14	15+	75+	150+
€	14,783	14,261	13,739	13,435



vrátane mikrovláknovej  
čistiacej utierky



**41511.H**

Svetlohnedá aktovka LA PEARL

405 x 310 x 130 mm  
umelá koža  
razba

ks	1-9	10+	50+	100+
€	19,522	18,217	17,348	16,478







41502.H

Kožená aktovka  
PIERRE CARDIN

440 x 360 x 130 mm  
razba

ks	1-2	3+	15+	30+
€	151,739	147,391	144,783	143,043



16184.C

Aktovka Silver-line so zámkom  
a bohatou vnútornou výbavou

400 x 310 x 90 mm  
umelá koža  
laserový popis, razba, sietotlač

ks	1-2	3+	15+	30+
€	65,878	61,837	59,633	58,245

v obale z netkanej textilie



41514.H

Tmavohnedá aktovka LA PEARL

405 x 340 x 90 mm  
umelá koža  
razba

ks	1-9	10+	50+	100+
€	20,565	19,087	17,783	16,913



# Peňaženky, dokladovky



61067.V

Kožená taška do ruky

220 x 160 x 70 mm  
tampoprint, razba

ks	1-9	10+	50+	100+
€	32,565	30,043	27,913	26,043



38301.H

Darčeková sada s peňaženkou Millau

193 x 163 x 35 mm (box)  
118 x 97 x 15 mm (peňaženka)  
Ø 12 x 127 mm (pero) / 45 x 61 mm (prívesok)  
umelá koža  
tampoprint, razba, laserový popis

ks	1-4	5+	25+	50+
€	33,304	32,087	30,957	30,217

BALMAIN  
PARIS



38303.C

Dve priehradky na účtenky či bankovky, osem priehradok na karty, dve doplnkové priehradky. Gulíčkové pero má čiernu náplň.

50088.C

Darčeková sada s peňaženkou

175 x 165 x 35 mm (box)  
113 x 90 x 15 mm (peňaženka)  
Ø 10 x 136 mm (pero) / 15 x 102 mm (prívesok)  
umelá koža  
tampoprint, laserový popis

ks	1-9	10+	50+	100+
€	18,130	17,478	16,826	16,435

Dve priehradky na účtenky či bankovky, päť priehradok na karty, z toho jedna priehľadná, dve doplnkové priehradky. Gulíčkové pero ná modrú náplň.



37960.C

Darčeková sada s peňaženkou Versailles

138 x 190 x 23 mm (box)  
92 x 125 x 15 mm (peňaženka)  
Ø 14 x 130 mm (pero)  
umelá koža  
tampoprint, razba

ks	1-19	20+	100+	200+
€	12,739	12,391	12,130	11,870

Veľká priehradka na účtenky či bankovky, 8 priehradok na karty, jeden oddiel na zips (vhodný i na mince), jedna priestranná doplnková priehradka. Gulíčkové pero ná čiernu náplň.



BALMAIN  
PARIS



37922.C

Peňaženka BALMAIN Chamonix  
z imitácie kože a mikrovláknna

105 x 90 x 20 mm  
umelá koža/mikrovláknno  
tampoprint, razba

ks	1-7	8+	40+	80+
€	22,217	21,391	20,609	20,130



Priehradka na mince, 2 veľké priehradky na účtenky, 4 priehradky na karty, 2 väčšie vrecká.

BALMAIN  
PARIS

všetko  
novinky



37923.C

Obal na karty BALMAIN Chamonix  
z imitácie kože a mikrovláknna

85 x 115 x 20 mm  
umelá koža/mikrovláknno  
tampoprint, razba

ks	1-7	8+	40+	80+
€	22,217	21,391	20,609	20,130

Sedem priehradok na karty,  
veľká priehradka na viacero  
kariet, dve väčšie priehradky.



MARKSMAN



37920.C

Peňaženka MARKSMAN z tarpaulínu  
s ochrannou vnútornou fóliou

92 x 118 x 15 mm  
tarpaulín  
tampoprint, sieťotlač

ks	1-7	8+	40+	80+
€	20,957	20,174	19,478	19,000

Ochranná metalická podšívka ochráni čip  
na kreditných kartách pred rádiovými vlnami.

Priehradka na mince, 2 veľké priehradky na bankovky,  
4 priehradky na karty, 2 väčšie priehradky.



61160.C

ks	1-9	10+	50+	100+
€	26,043	24,478	23,609	23,087



Priehradka na mince, dva oddiely na účtenky či bankovky, štyri priehradky na karty, tri väčšie priehradky.

Kožená peňaženka SAMSONITE

125 x 95 x 20 mm  
tampoprint, razba

61161.C

ks	1-9	10+	50+	100+
€	30,217	28,478	27,609	26,739



Priehradka na mince, dva oddiely na účtenky či bankovky, osem oddielov na karty, päť väčších priehradok, jedna priehľadná vyklápacia.



**Samsønite®**

61159.C

Kožená peňaženka SAMSONITE

100 x 120 x 20 mm  
tampoprint, razba

ks	1-9	10+	50+	100+
€	26,043	24,478	23,609	23,087



Veľká priehradka na mince s cvokom, dve priehradky na bankovky či účtenky, päť oddielov na karty, tri väčšie priehradky.



37924.C

Peňaženka BALMAIN Deauville  
z imitácie kože a mikrovláknna

novinka

BALMAIN  
PARIS

120 x 90 x 10 mm  
umelá koža/mikrovláknno  
transfer

ks	1-7	8+	40+	80+
€	27,130	26,130	25,217	24,609

Dvojitá priehradka na mince so zipsom,  
priehradka na účtenky či bankovky,  
osem oddielov na karty, 2 väčšie oddiely,  
zapínanie na cvok.



61164.R

Dámska kožená peňaženka  
SAMSONITE

130 x 100 x 20 mm  
tampoprint, razba

ks	1-7	8+	40+	80+
€	33,783	32,043	30,739	29,870

Priehradka na mince so zipsom,  
oddiel na účtenky či bankovky,  
osem oddielov na karty, štyri väčšie  
priehradky, zapínanie na cvok.



Sams<sup>o</sup>nite®



61168.R

Dámska kožená peňaženka  
SAMSONITE

100 x 120 x 20 mm  
tampoprint, razba

ks	1-9	10+	50+	100+
€	30,217	28,478	27,609	26,739

Priehradka na mince, dva oddiely  
na účtenky či bankovky, šesť oddielov  
na karty, šesť väčších priehradok,  
jedna priehradná, zapínanie na cvok.



**61071.H**

**Kožená peňaženka**

100 x 125 x 20 mm  
tampoprint, razba

ks	1-14	15+	75+	150+
€	15,435	14,261	13,217	12,348

Priehradka na mince, dva oddiely na účtenky či bankovky, deväť oddielov na karty, dva vnútorné priehľadné oddiely, dve väčšie priehradky, vnútorná priehradka na zips. Vnútorné priehradky sú zaistené cvokom.



**61113.C**

**Kožená peňaženka**

100 x 120 x 20 mm  
tampoprint, razba

ks	1-14	15+	75+	150+
€	12,391	11,478	10,652	9,957

Veľká priehradka na mince, dva oddiely na účtenky či bankovky, štyri oddiely na karty, tri väčšie priehradky.



**61112.C**

**Kožená peňaženka**

115 x 100 x 20 mm  
tampoprint, razba

ks	1-14	15+	75+	150+
€	13,000	12,000	11,130	10,391

Veľká priehradka na mince, dva oddiely na účtenky či bankovky, sedem oddielov na karty, z toho jeden priehľadný, väčšia priehľadná vnútorná priehradka, dve vnútorné priehradky. Vnútorný oddiel zaistený cvokom.



Veľká priehradka na mince, dva oddiely na účtenky či bankovky, štyri oddiely na karty, dve väčšie priehradky, priehradka na zips. Vnútrorná vsadka obsahuje tri oddiely na karty a tri väčšie priehradky, z toho jednu priehľadnú. Vsadka je zaistená cvokom.



61114.C

Luxusná kožená peňaženka so vsadkou na cvok

95 x 130 x 25 mm  
tampoprint, razba

ks	1-14	15+	75+	150+
€	15,174	14,043	13,043	12,217



61052.C

Kožená peňaženka so vsadkou

95 x 125 x 20 mm  
tampoprint, razba

ks	1-14	15+	75+	150+
€	12,565	11,870	11,174	10,565

Veľká priehradka na mince, dva oddiely na účtenky či bankovky, štyri oddiely na karty, tri väčšie priehradky. Vnútrorná vsadka obsahuje štyri oddiely na karty a štyri väčšie oddiely, z toho jeden priehľadný.



61115.C

Kožená peňaženka

110 x 100 x 20 mm  
tampoprint, razba

ks	1-19	20+	100+	200+
€	11,522	10,652	9,870	9,217

Priehradka na mince, dva oddiely na účtenky či bankovky, štyri oddiely na karty, dve väčšie priehradky.





**61111.C**  
Menšia kožená peňaženka  
s množstvom vreciek

85 x 105 x 20 mm  
tampoprint, razba

ks	1-14	15+	75+	150+
€	12,130	11,522	10,652	10,130

Priehradka na mince, dva oddiely na účtenky či bankovky, šesť oddielov na karty, z toho dva priehľadné, menší priehľadný oddiel napr. na fotografie. Oddiely na karty sú zaistené cvokom. Priehradka na zips, dve doplnkové priehradky.



**61068.H**  
Menšia kožená peňaženka  
s bohatou výbavou

85 x 105 x 20 mm  
tampoprint, razba

ks	1-19	20+	100+	200+
€	11,174	10,348	9,609	8,957

Priehradka na mince, dva oddiely na účtenky či bankovky, desať oddielov na karty, z toho dva priehľadné napr. na fotografie. Oddiely na karty sú zaistené cvokom. Priehradka na zips, dve doplnkové priehradky.



Priehradka na mince, dva oddiely na účtenky či bankovky, päť oddielov na karty, jedna väčšia priehradka.



**61059.P**  
Kožená peňaženka

116 x 102 x 15 mm  
tampoprint, razba

ks	1-19	20+	100+	200+
€	11,522	10,652	9,870	9,217





61026.V

Dámska kožená peňaženka  
z elegantnej vínovej kože

90 x 135 x 25 mm  
tampoprint, razba

ks	1-9	10+	50+	100+
€	17,261	16,217	15,435	14,652

Veľká priehradka na mince,  
dva menšie oddiely na účtenky  
či bankovky, veľká priehradka  
na bankovky, tri oddiely na karty,  
z toho jeden priehľadný,  
priehradka na zips.



Priehradka na mince, veľký oddiel na účtenky  
či bankovky, deväť oddielov na karty,  
priehľadný oddiel na doklady či fotografie.



61027.H

Dámska kožená peňaženka  
z luxusnej lesklej hnedej kože

145 x 100 x 25 mm  
tampoprint, razba

ks	1-9	10+	50+	100+
€	20,304	18,783	17,435	16,304



61025.H

Dámska kožená peňaženka

184 x 110 x 30 mm  
tampoprint, razba

ks	1-9	10+	50+	100+
€	19,043	17,565	16,304	15,217

Veľká priehradka na mince so zipsom na účtenky  
či bankovky, priehradka so zipsom, sedem oddielov  
na karty, z toho tri priehľadné, nižší predný oddiel  
a veľká vnútorná priehradka.



 **andré philippe**

**80489.C**

Pánska koženková peňaženka André Philippe s kontrastným prešíťím

novinka

115 x 96 x 18 mm  
umelá koža  
tampoprint, razba

ks	1-24	25+	125+	250+
€	7,957	7,652	7,348	7,174

Veľká priehradka na účtenky či bankovky, šesť oddielov na karty, dve väčšie priehradky, dve priehľadné priehradky, zapínanie na cvok.



**Dámska koženková peňaženka**

185 x 90 x 25 mm  
tampoprint, sieťotlač

ks	1-49	50+	250+	500+
€	4,326	4,152	3,987	3,883

Menšia priehradka na mince so zipsom, dva oddiely na bankovky, šesť oddielov na karty, dve doplnkové priehradky.



**80488.C**

**80481.C**



Tri oddiely na karty, priehradka na mince.

**80480.H**



**Koženková peňaženka**

100 x 80 x 15 mm  
tampoprint

ks	1-99	100+	500+	1000+
€	1,735	1,678	1,613	1,570



**80487.R**



Dve priehradky na zips, jedna priehradka na cvok.



**42206.C**

**Kožená kľúčenka s peňaženkou**

100 x 70 x 10 mm  
tampoprint

ks	1-199	200+	1000+	2000+
€	0,752	0,700	0,657	0,617



**50086.C**

**Peňaženka na mince**

88 x 84 x 25 mm  
umelá koža  
tampoprint, razba

ks	1-99	100+	500+	1000+
€	1,957	1,887	1,817	1,774



novinka



**37921.C**  
Puzdro na doklady a karty  
s peňaženkou BALMAIN Auvergne

130 x 240 x 15 mm  
umelá koža  
sietotlač, razba

ks	1-7	8+	40+	80+
€	23,435	22,565	21,783	21,261

Priehradka na mince, päť priehradok na karty, dve veľké priehradky na pasy a doklady, oddiel na SIM kartu, pútko na pero. Pero nie je súčasťou.



**BALMAIN**  
PARIS

37966.C

Puzdro na doklady a letenky

137 x 257 x 20 mm  
polyester 600D  
sietotlač, transfer

ks	1-39	40+	200+	400+
€	4,913	4,739	4,565	4,478



16083.C

Cestovné puzdro Classico  
na doklady a karty

135 x 230 x 10 mm  
umelá koža  
tampoprint, laserový popis, sietotlač

ks	1-19	20+	100+	200+
€	11,673	10,939	10,571	10,327



v obale z netkanej textíliem, obsah s perom nie je súčasťou



30067.R

Obal na 12 CD/DVD

155 x 160 x 30 mm  
polyester 600D  
sietotlač, transfer

ks	1-79	80+	400+	800+
€	2,426	2,335	2,252	2,200

30066.C



51107.M

Obal na 24 CD/DVD

145 x 140 x 50 mm  
sietotlač

ks	1-59	60+	300+	600+
€	3,017	2,870	2,735	2,674





# Drobnosti osobnej potreby



20912.R

Skladacie slnečné okuliare s UV400 ochranou

novinka

145 x 130 x 50 mm  
tampprint

ks	1-119	120+	600+	1200+
€	1,617	1,557	1,500	1,465



20910.C



20911.M



20913.B



20914.E



20915.Z

**TODD** modo

Papierové vreckovky s reklamou

počet kusov plnofarebná tlač

od 2500 ks 0,587

od 5000 ks 0,517

od 10000 ks 0,448

od 15000 ks 0,413

od 20000 ks 0,374

cena je vrátane plnofarebnej tlače

90601.Q

Papierové vreckovky

75 x 55 x 15 mm

od 0,374



Baliček obsahuje 5 vreckoviek z čistej bielej štvorvrstvej celulózy, zafóliované balenie obsahuje 9 balíčkov. Celoplošná potlač je realizovaná rotačnou ofsetovou tlačou, buď farbami Pantone alebo CMYK. Zatváranie je zabezpečené lepiacou etiketou.

Možnosti farieb lepiacich etikiet:



1. červená
2. modrá
3. zelená
4. žltá
5. čierna



20884.M

20885.S

Čistiace vlhčené vreckovky

145 x 75 mm  
tampprint

ks	1-399	400+	2000+	4000+
€	0,522	0,504	0,487	0,474

10 ks vreckoviek  
170 x 200 mm



20888.B

Čistiace vlhčené vreckovky v plastovom boxe

70 x 100 x 38 mm  
tampprint

ks	1-199	200+	1000+	2000+
€	1,257	1,209	1,165	1,139

20 ks vreckoviek  
170 x 200 mm





**Parfumový rozprašovač s matným povrchom**

15 x 80 x 15 mm  
tampoprint, laserový popis

ks	1-129	130+	650+	1300+
€	1,517	1,461	1,409	1,374

objem 5 ml



20853.G

20852.S

80322.C

80320.R



**Sada piatich kozmetických štetcov**

Ø 18 x 155 mm  
tampoprint

ks	1-149	150+	750+	1500+
€	1,200	1,152	1,104	1,078



80321.M



**Župan so šalovým golierom 420 g/m<sup>2</sup>**

100% bavlnené froté 420 g/m<sup>2</sup>  
veľkosť S-XXL  
výšivka

51342.S



51341.E

**Balzam na pery s vanilkovou príchťou**

Ø 36 x 20 mm  
tampoprint

ks	1-199	200+	1000+	2000+
€	1,074	1,035	1,000	0,974



Biely župan					
veľkosť	kód	1-4	5+	25+	50+
S	90671.B	31,522	30,261	29,130	28,043
M	90672.B				
L	90673.B	33,174	31,870	30,652	29,522
XL	90674.B				
XXL	90675.B				

**Balzam na pery, SPF 15**

Ø 18 x 70 mm  
tampoprint

ks	1-399	400+	2000+	4000+
€	0,487	0,465	0,452	0,439



31621.M



31620.E



31622.M



31623.R



31626.O



31625.Z



31628.B



31629.C



**90083.B**

Biely froté uterák 400 g/m<sup>2</sup>, vrátane tlače do bordúry  
300 x 500 mm

od **2,478**

**90084.B**

Biely froté uterák 400 g/m<sup>2</sup>, vrátane tlače do bordúry  
500 x 1 000 mm

od **5,000**

**90085.B**

Biela froté osuška 400 g/m<sup>2</sup>, vrátane tlače do bordúry  
700 x 1 400 mm

od **8,652**



Uteráky a osušky s tlačou do bordúry			
	90083.B	90084.B	90085.B
1–9 ks	–	–	–
10–24 ks	–	–	12,130
25–49 ks	–	7,130	11,435
50–99 ks	3,609	6,696	10,739
100–199 ks	3,522	6,217	9,739
200–499 ks	3,087	5,565	9,261
500–999 ks	2,739	5,130	8,783
1 000 a viac ks	2,478	5,000	8,652
Technická príprava	paušál 12 €		

Froté walk 100% bavlna, 400 g/m<sup>2</sup>, plnofarebné logo tlačené do jednostrannej bordúry vysokej 70 mm. Balenie uterákov a osušiek do obalu +0,13 €/ks

Potlač sublimačnou technológiou je vhodná i pre plnofarebné obrázky a logá, pri ktorých vynikne každý detail. Mäkkosť uteráka ostáva plne zachovaná, výsledná tlač je stálofarebná i pri praní vo vysokých teplotách.

Sublimačná tlač do bordúry farebných uterákov vám radi vykalkulujeme na dopyt.



Kódy uterákov Luxury 400 g/m<sup>2</sup>, 300 x 500 mm

farba	kód
biela	90081.B
krémová	90072.L
tmavožltá	90077.Y
oranžová	90073.O
svetlomodrá	90074.M
svetlozelená	90080.Z
červená	90079.R
stredne modrá	90075.M
tmavomodrá	90076.M
tmavozelená	90078.Z

Ceny uterákov Luxury 400 g/m<sup>2</sup>, 300 x 500 mm

ks	1-99	100+	500+	1000+
Biely uterák	1,265	1,217	1,170	1,126
Farebný uterák	1,422	1,365	1,313	1,265

Balenie uterákov do obalu +0,13 €/ks

Uterák Luxury 400 g/m<sup>2</sup>

100% bavlnené froté  
300 x 500 mm  
výšivka

od **1,126**



**90091.T**

PVC obal na uterák s farebnou sťahovacou šnúrkou  
120 x 250 mm

ks	1-99	100+	500+	1000+
€	1,070	1,030	0,991	0,952



Farbu šnúrky je možné zvoliť.

**90092.T**

PVC obal na osušku s farebnou sťahovacou šnúrkou  
140 x 300 mm

ks	1-99	100+	500+	1000+
€	1,300	1,257	1,213	1,170

Ďalšie možné obaly, ceny na vyžiadanie:

Veža



Box



Transparentný s mašličkou





Kódy uterákov a osušiek Premium 470 g/m <sup>2</sup>			
	farba	uteráky	osušky
svetlé farby	biela	90041.B	90061.B
	svetložltá	90043.Y	90063.Y
	tmavožltá	90044.Y	90064.Y
	oranžová	90045.O	90065.O
	svetlomodrá	90047.M	90067.M
tmavé farby	červená	90046.R	90066.R
	stredne modrá	90048.M	90068.M
	tmavomodrá	90049.M	90069.M
	tmavozelená	90050.Z	90070.Z
	grafitová	90051.K	90071.K

Ceny uterákov a osušiek Premium 470 g/m <sup>2</sup>				
ks	1-49	50+	200+	400+
Biely uterák	4,122	3,957	3,809	3,670
Svetlý uterák	4,391	4,204	4,043	3,896
Tmavý uterák	5,043	4,826	4,652	4,478
ks	1-24	25+	100+	200+
Biela osuška	8,130	7,826	7,522	7,261
Svetlá osuška	8,652	8,304	8,000	7,696
Tmavá osuška	9,957	9,522	9,174	8,826

Premium 470 g/m<sup>2</sup>

100% bavlnené froté  
uteráky 500 x 1 000 mm  
osušky 700 x 1 400 mm  
výšivka

od 3,<sup>670</sup>

Uteráky a osušky Premium 470 g/m<sup>2</sup>  
s dvomi širokými ozdobnými bordúrami

Balenie uterákov a osušiek do obalu +0,13 €/ks



Kódy uterákov a osušiek Luxury 400 g/m <sup>2</sup>			
	farba	uteráky	osušky
svetlé farby	biela	90001.B	90021.B
	krémová	90002.L	90022.L
	svetložltá	90003.Y	90023.Y
	tmavožltá	90004.Y	90024.Y
	oranžová	90005.O	90025.O
	svetlomodrá	90007.M	90027.M
	svetlošedá	90014.J	90034.J
	piesková	90015.P	90035.P
	tyrkysová	90016.I	90036.I
	fialová	90017.F	90037.F
tmavé farby	svetlozelená	90013.Z	90033.Z
	červená	90006.R	90026.R
	stredne modrá	90008.M	90028.M
	tmavomodrá	90009.M	90029.M
	tmavozelená	90010.Z	90030.Z
	čierna	90011.C	90031.C
	vínová	90012.R	90032.R
	ružová	90018.E	90038.E

Ceny uterákov a osušiek Luxury 400 g/m <sup>2</sup>				
ks	1-49	50+	200+	500+
Biely uterák	3,509	3,370	3,243	3,126
Svetlý uterák	3,761	3,613	3,474	3,348
Tmavý uterák	4,309	4,139	3,978	3,835
ks	1-24	25+	100+	250+
Biela osuška	6,870	6,609	6,348	6,130
Svetlá osuška	7,391	7,087	6,826	6,565
Tmavá osuška	8,478	8,130	7,826	7,522

Luxury 400 g/m<sup>2</sup>

100% bavlnené froté  
uteráky 500 x 1 000 mm  
osušky 700 x 1 400 mm  
výšivka

od 3,<sup>126</sup>

Uteráky a osušky Luxury 400 g/m<sup>2</sup>  
s dvomi tenkými bordúrami

Balenie uterákov a osušiek do obalu +0,13 €/ks

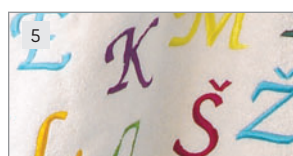

1. výšivka do bordúry
2. vtkávanie do bordúry  
(uteráky min. 800 ks/osušky min. 600 ks)
3. vtkávanie do plochy (1 000 ks/800 ks)
4. plastické vtkávanie (800 ks/600 ks)
5. výšivka do plochy froté
6. tlač do plochy (7 000 ks/5 000 ks)
7. tlač do bordúry



viečko škatulky potiahnuté rovnakou látkou ako kravata

80329.R



80328.M



Polyesterová kravata v darčekovej krabičke

novinka

110 x 110 x 70 mm (box)  
tampoprint, transfer (na box)

ks	1-24	25+	125+	250+
€	9,087	8,652	8,304	8,130

80339.R



80338.M



80340.J



Hodvábna kravata André Philippe v darčekovej krabičke

novinka

110 x 110 x 70 mm (box)  
tampoprint, transfer (na box)

ks	1-9	10+	50+	100+
€	20,174	19,348	18,565	18,087

80337.J



viečko škatulky potiahnuté rovnakou látkou ako kravata

80342.S

Sada manžetových gombíkov a spony na kravatu v darčekovej krabičke

novinka

75 x 58 x 28 mm (box)  
tampoprint (na box)

ks	1-24	25+	125+	375+
€	9,000	8,565	8,217	8,043



novinka

80343.P

Drevený vešiak na kravaty

300 x 135 x 15 mm  
tampoprint, sietotlač, laserový popis

ks	1-39	40+	200+	400+
€	4,957	4,783	4,565	4,478



80341.S

Manžetové gombíky André Philippe v darčekovej krabičke

novinka

85 x 35 x 45 mm (box)  
tampoprint (na box)

ks	1-24	25+	125+	250+
€	7,739	7,435	7,130	6,957



 andré philippe

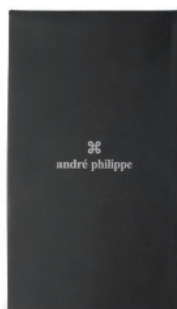

80325.C

Kožený opasok s dvoma výmennými sponami v darčekovej krabičke

dĺžka opasku 1200 mm  
tampoprint, sietotlač (box)

ks	1-14	15+	75+	150+
€	13,000	12,522	12,087	11,783







**20875.Q**  
Darčeková kozmetická sada  
s uterákom

210 x 112 x 50 mm (box)  
tampoprint

ks	1-14	15+	75+	150+
€	12,957	12,478	12,043	11,783

sprchový gél, telové  
mlieko, mydlo, uterák



**36019.Q**

Sada do kúpeľa Bohemian

novinka

130 x 117 x 125 mm  
tampoprint, sietotlač (na box)

ks	1-19	20+	100+	200+
€	11,087	10,696	10,304	10,043



sprchový gél, telové mlieko, kúpeľová soľ, špongia

**20874.Q**

Darčeková kozmetická sada

245 x 165 x 60 mm (box)  
tampoprint

ks	1-19	20+	100+	200+
€	9,435	9,087	8,739	8,565



parfumovaný sprchový gél,  
telové mlieko, mydlo,  
froté špongia



**31634.E**  
granátové  
jablko

novinka

Sada do kúpeľa

120 x 120 x 43 mm  
tampoprint, sietotlač (na obal)

ks	1-39	40+	200+	400+
€	6,130	5,913	5,696	5,565

sprchový gél, telové mlieko, šampón



**31636.Z**  
zelený čaj



**31635.Y**  
vanilka



**80324.C**

Sada štyroch čadičových kameňov  
pre horúcu masáž v zamatovom obale

140 x 170 mm  
transfer (na vrecúško)

ks	1-79	80+	400+	800+
€	2,543	2,439	2,343	2,283





novinka

31637.Q

Kľúčienka s indikátorom UV žiarenia

Ø 35 mm

ks	1-199	200+	1000+	2000+
€	0,970	0,935	0,900	0,878



novinka

31638.Q

Náramok s indikátorom UV žiarenia

Ø 40 x 230 x 2 mm

ks	1-199	200+	1000+	2000+
€	1,104	1,061	1,022	1,000



20879.B

Digitálny merač krvného tlaku B-control v plastovom boxe

86 x 90 x 70 mm (box)  
tampoprint

ks	1-9	10+	50+	100+
€	29,783	28,652	27,652	27,000



36024.C



36026.M



36027.R

Silikónový náramok s dvomi hologramami

**BALANCE 3000**

Ø 62 x 20 mm  
tampoprint

ks	1-59	60+	300+	600+
€	3,683	3,548	3,417	3,339

Zázračné hologramy optimalizujú využitie energie vášho tela a zvyšujú výkon organizmu.



43221.B

Digitálny teplomer

130 x 20 x 12 mm  
tampoprint

ks	1-99	100+	500+	1000+
€	2,126	1,961	1,822	1,700

80327.S

Kovová krabička na lieky s tromi plastovými priehradkami

Ø 48 mm  
tampoprint, laserový popis

ks	1-99	100+	500+	1000+
€	1,887	1,813	1,739	1,696



52192.I

Lekárnička

110 x 68 x 37 mm  
tampoprint, sieťotlač

ks	1-69	70+	350+	700+
€	2,739	2,639	2,543	2,487



52191.R



80334.R



80336.C



80335.M

**Skladací cestovný fén**140 x 200 x 68 mm  
tampoprint

novinka

ks	1-14	15+	75+	150+
€	12,913	12,391	11,870	11,565

220-240 V, 1200 W

**Kozmetická taška  
s háčikom na zavesenie**200 x 180 x 90 mm  
sietotlač, transfer

ks	1-29	30+	150+	300+
€	6,826	6,565	6,348	6,217



20899.R



20898.C

**44715.C****Polyesterová toaletná taška**290 x 195 x 90 mm  
sietotlač, transfer

ks	1-49	50+	250+	500+
€	3,009	2,778	2,578	2,409

**20895.R**

20896.L



20881.M

**Cestovné šitie**68 x 63 x 15 mm  
tampoprint

ks	1-139	140+	700+	1400+
€	1,404	1,352	1,300	1,274



20882.B

**Kozmetická taška  
s kontrastnými lemmami**260 x 200 x 135 mm  
sietotlač, transfer

ks	1-49	50+	250+	500+
€	3,787	3,643	3,517	3,435



**20880.S**  
Skladací kovový držiak  
na tašku ako kľúčienka

novinka

55 x 20 x 10 mm  
tampoprint, laserový popis

ks	1-99	100+	500+	1000+
€	2,074	1,996	1,926	1,878

nosnosť 2,5kg

20878.S



Praktický držiak na tašku  
Ø 47 x 7 mm  
tampoprint

ks	1-119	120+	600+	1200+
€	1,648	1,587	1,530	1,496



20877.C

16080.S

Skladací držiak na tašku  
so zrkadielkom

Ø 45 x 13 mm  
tampoprint, laserový popis

ks	1-39	40+	200+	400+
€	4,367	4,122	3,959	3,869



Dvojité zrkadielko  
69 x 64 x 11 mm  
tampoprint

ks	1-299	300+	1500+	3000+
€	0,652	0,630	0,604	0,591



50146.S

50145.C

16257.M

16255.G

16256.R



Elegantný alumíniový zápisník  
s modro písucim miniperom

70 x 110 x 10 mm  
tampoprint, laserový popis

ks	1-59	60+	300+	600+
€	3,457	3,245	3,127	3,057



50133.TR



Transparentné dvojité  
kozmetické zrkadlo  
Ø 70 x 10 mm  
tampoprint

ks	1-299	300+	1500+	3000+
€	0,557	0,535	0,517	0,504

50134.TO



50132.TM

50135.TZ

50131.TB



**44831.S**  
Manikúra Luxus

105 x 69 x 22 mm  
tampoprint

ks	1-29	30+	100+	200+
€	5,391	4,957	4,696	4,478



**44806.S**  
Manikúra v kovovom  
boxe so zrkadlom

106 x 66 x 19 mm  
tampoprint, laserový popis

ks	1-79	80+	400+	800+
€	2,574	2,374	2,204	2,061



**50150.S**  
Dvojité zrkadielko

Ø 60 x 5 mm  
tampoprint, laserový popis

ks	1-99	100+	500+	1000+
€	1,809	1,743	1,683	1,643



**44803.S**  
Manikúra v kovovej tube

43 x 115 x 30 mm  
tampoprint, laserový popis

ks	1-99	100+	500+	1000+
€	2,039	1,965	1,896	1,848



**20771.R**



**Manikúra**  
110 x 50 x 20 mm  
tampoprint

ks	1-89	90+	450+	900+
€	2,352	2,265	2,183	2,130



**20770.C**



**16046.K****Luxusná hliníková manikúra  
s gumovou sponou**107 x 80 x 15 mm  
tampoprint, laserový popis

ks	1-19	20+	100+	200+
€	10,041	9,388	9,061	8,857

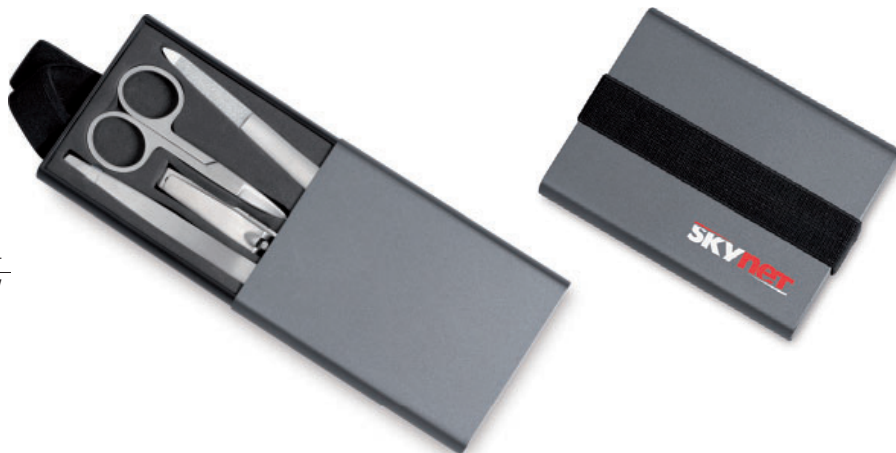
**44842.C****Manikúra**155 x 90 x 20 mm  
tampoprint, razba

ks	1-29	30+	100+	200+
€	6,043	5,565	5,174	4,826

**44830.S****Manikúra Luxus**46 x 115 x 30 mm  
tampoprint

ks	1-39	40+	200+	400+
€	5,043	4,652	4,317	4,026

**44841.C****Manikúra**72 x 118 x 15 mm  
tampoprint, razba

ks	1-49	50+	200+	400+
€	3,896	3,596	3,339	3,113



44808.H

Luxusná osemdielna manikúra  
v hnedom obale z umelej kože

155 x 85 x 20 mm  
tampoprint, laserový popis

ks	1-19	20+	100+	200+
€	10,739	9,913	9,174	8,565



Súčasťou manikúr 4480x.H je voľne priložený  
kovový štítok (35 x 15 x 1 mm) pre umiestnenie loga.



44807.H

Luxusná sedemdielna manikúra  
v hnedom obale z umelej kože

170 x 80 x 20 mm  
tampoprint, laserový popis

ks	1-19	20+	100+	200+
€	9,783	9,087	8,435	7,870



16063.C

Luxusná manikúra v umelej koži

140 x 90 x 16 mm  
tampoprint, laserový popis

ks	1-19	20+	100+	200+
€	10,735	10,082	9,714	9,510





# Domáca pohoda

30256.B

Aromatická sada s vôňou vanilky

88 x 108 x 32 mm (box)  
tampoprint

ks	1-99	100+	500+	1000+
€	1,830	1,761	1,700	1,661



80450.Q

Sada 6 ks sviečok s vanilkovou a čokoládovou vôňou a čiernou komplimentkou

75 x 110 x 20 mm (box)  
tampoprint

ks	1-99	100+	500+	1000+
€	2,070	1,983	1,904	1,857



20553.L

vôňa škorice



20551.H

vôňa kávy



Aromatická sviečka v boxe ovinutom špagátikom

Ø 62 x 50 mm  
tampoprint, laserový popis

ks	1-199	200+	1000+	2000+
€	1,222	1,178	1,135	1,109



20552.B

vôňa vanilky

Relaxačná hudba ako darček do obálky

140 x 160 x 5 mm  
tampoprint, sieťotlač

ks	1-299	300+	1500+	3000+
€	0,670	0,622	0,574	0,539

41613.Q



41611.Q



41612.Q



Relaxačno – aromatická sada s CD

155 x 155 x 30 mm (box)  
tampoprint

ks	1-29	30+	150+	300+
€	5,609	5,174	4,739	4,304

41621.Q



41622.Q







90153.Q

Darčeková sada čajov LIPTON –  
12 x 15 ks v papierovom boxe306 x 254 x 75 mm  
tampoprint

ks	1-9	10+	50+	100+
€	26,043	25,174	24,304	23,696

90152.P

Darčeková sada čajov PICKWICK –  
10 x 10 ks v drevenom boxe345 x 220 x 70 mm  
tampoprint, laserový popis

ks	1-4	5+	25+	500+
€	34,565	33,696	32,391	31,304



30254.S

Aromatická sada s vôňou konvalinky

65 x 270 x 65 mm (box)  
tampoprint

ks	1-29	30+	150+	300+
€	8,609	8,304	8,000	7,826



28339.R

Flísová deka s rukávmi  
a komplimentkou1800 x 1200 mm  
flís 180 g/m<sup>2</sup>  
tampoprint, výšivka

ks	1-19	20+	100+	200+
€	11,043	10,652	10,261	10,043

28338.M

30260.H

Aromatická sada s vôňou prírody

150 x 120 x 37 mm  
tampoprint, sietotlač

ks	1-39	40+	200+	400+
€	6,130	5,913	5,696	5,565

2 vonné sviečky v bielych keramických miskách, 19 vonných tyčínok, 19 vonných kužeľov, keramický držiak vonných tyčínok. Vôňa jesenného lesa.



30255.F

Aromatická sada  
s vôňou levandule170 x 135 x 55 mm (box)  
tampoprint

ks	1-69	70+	350+	700+
€	3,087	2,974	2,865	2,800





Hudobný časovač BeepEgg Classic na varenie vajíčok v oválnom obale

Ø 45 x 55 mm (vajíce)/Ø 49 x 60 mm (obal)  
tampoprint

ks	1-14	15+	75+	150+
€	14,304	13,870	13,435	13,000

Od 50 ks možnosť individualizácie kombinácií farieb.

**Melódie BeepEgg Classic**  
namätko: Killing Me Softly  
na hniličku: Triumphal March – Aida (G. Verdi)  
natvrdo: Malá nočná hudba (W. A. Mozart)



novinka

91863.Y

BeepEgg®

Na varenie časovača spolu s vajíčkami. Tromi melódiami oznámi stav varenia pre tri stupne tuhosti žĺtka.



91861.M

91864.R

91862.C

91860.B

91866.C

Hudobný časovač BeepEgg Rock na varenie vajíčok v panorama obale

novinka



Ø 45 x 55 mm (vajíce)/52 x 55 x 89 mm (obal)  
tampoprint

ks	1-9	10+	50+	100+
€	18,043	17,609	17,174	16,739

**Melódie BeepEgg Rock**  
namätko: Smoke on the Water (Deep Purple)  
na hniličku: I Was Made for Loving You (Kiss)  
natvrdo: Final Countdown (Europe)

91867.E

Hudobný časovač BeepEgg Disco na varenie vajíčok v panorama obale

novinka



**Melódie BeepEgg Disco**  
namätko: Celebration  
na hniličku: That's the Way I Like It  
natvrdo: Last Night a DJ Saved My Life



Designed in Germany

novinka

CREGG – otvárač na vajíčka so stojanom v priehľadnej krabičke

70 x 70 x 13 mm (obal)  
tampoprint

ks	1-29	30+	150+	300+
€	5,435	5,261	5,087	4,913



91877.Z

cregg

Tento unikátny otvárač dokáže tromi čepeľami odrezať škrupinu vajíčka a uľahčí tak prístup k žĺtku. Zároveň slúži ako stojan na vajíčko.



91870.B



91875.Y



91874.O



91873.R



91876.F



91872.C

91878.Q

CREGG double – sada dvoch otváračov na vajíčka so stojanom v priehľadnej krabičke

novinka

155 x 140 x 13 mm (obal)  
tampoprint

ks	1-19	20+	100+	200+
€	10,130	9,696	9,348	9,000

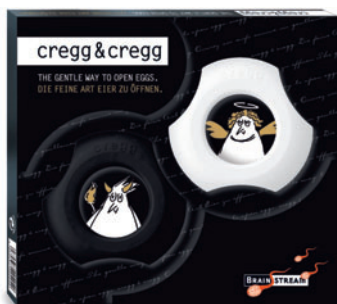

51170.S

Minútka s magnetom a klipom

55 x 55 x 10 mm  
tampoprint

ks	1-89	90+	450+	900+
€	2,152	2,074	2,000	1,952



**16059.B**

Elektrický mlynček na soľ i korenie

Ø 65 x 220 mm  
tampoprint

ks	1-19	20+	100+	200+
€	10,367	9,714	9,347	9,143

Mlecí mechanizmus je z odolnej keramiky.

**42974.S**

Kvalitný nerezový elektrický mlynček na soľ a korenie

Ø 70 x 205 mm  
tampoprint, laserový popis

ks	1-14	15+	75+	225+
€	13,000	12,000	11,174	10,435

Mlecí mechanizmus je z odolnej keramiky. Umožňuje plynulé nastavenie hrúbosti mletia. Dve výsuvné násypky pre ľahké doplnenie soli a korenia.

MECHANISM  
LIFETIME  
GUARANTEE**COLE & MASON****30501.C**

Luxusná darčeková sada mlynčekov na soľ a korenie Gourmet

Ø 52 x 190 mm (mlynček)  
190 x 230 x 110 mm (box)  
tampoprint, laserový popis

ks	1-4	5+	25+	50+
€	56,783	54,652	52,739	51,478

Mlecí mechanizmus mlynčeka na korenie je z tvrdennej uhlíkovej ocele a mlynčeka na soľ z odolnej keramiky, na obidva mechanizmy sa vzťahuje záruka 25 rokov. Telá mlynčekov sú z trvanlivého bukového dreva.

**16056.S**

Nerezový mechanický mlynček 2v1 Kopenhagen so stojanom

223 x 63 x 55 mm  
tampoprint, laserový popis

ks	1-9	10+	50+	100+
€	15,469	14,531	14,000	13,673

Mlecí mechanizmus je z odolnej keramiky. Umožňuje nastavenie 5 stupňov hrúbosti mletia. Dodáva sa vrátane elegantného stojanu.

Paul Bocuse

novinka

**30500.S**

Nerezový mlynček na soľ a korenie PAUL BOCUSE

Ø 50 x 220 mm  
tampoprint, laserový popis

ks	1-7	8+	40+	80+
€	20,957	20,174	19,478	19,000





90490.C

Sada šiestich steakových nožov  
VICTORINOX v darčekom balení

novinka

172 x 234 x 21 mm  
tampoprint, laserový popis

ks	1-4	5+	25+	50+
€	32,696	31,043	29,913	28,826

dĺžka noža 230 mm, dĺžka čepele 120 mm



16065.C

Keramiký nôž Cabo-cut

240 x 30 x 20 mm  
tampoprint, laserový popis

ks	1-9	10+	50+	100+
€	20,408	19,143	18,490	18,041

extrémne ostrý keramiký nôž  
s drevenou rukoväťou opatrenou  
karbónovou povrchovou úpravou.

51140.C

Extrémne ľahký a odolný keramiký nôž  
s 13cm čepeľov v darčekom boxe280 x 60 x 25 mm (box)  
tampoprint, sieťotlač (box)

ks	1-14	15+	75+	150+
€	13,348	12,870	12,391	12,130



VICTORINOX



90492.C

Škrabka na šúpanie ovocia  
a zeleniny VICTORINOX

novinka

75 x 20 x 150 mm

ks	1-49	50+	250+	500+
€	3,891	3,713	3,578	3,452



51141.Q

Sada keramikého noža,  
keramickej škrabky  
a plastovej doštičky240 x 145 x 25 mm (box)  
235 x 140 mm (podložka)  
tampoprint

ks	1-19	20+	100+	200+
€	10,783	10,391	10,000	9,783



35724.Q

Drevená doštička s krájačmi na syr

Ø 260 x 35 mm  
tampoprint, laserový popis

ks	1-19	20+	100+	200+
€	12,304	11,870	11,435	11,174



16058.P

Oválna bambusová doštička

300 x 200 x 18 mm  
tampoprint, laserový popis

ks	1-29	30+	150+	300+
€	6,612	6,204	6,000	5,837



# Jamie Oliver

**30264.Q**
**Sada piatich kuchynských nožov JAMIE OLIVER v plastovom bloku**

 220 x 375 x 125 mm (box)  
tampoprint

ks	1-4	5+	25+	50+
€	92,609	89,174	86,000	84,000

Sada obsahuje:  
11 cm nôž na súpanie a krájanie ovocia a zeleniny,  
15 cm nôž na väčšinu súpania a krájania,  
19 cm kuchársky nôž na sekanie  
20 cm kuchynský nôž na krájanie mäsa strednej veľkosti  
22 cm nôž na krájanie chleba.

**novinka**
**51173.Q**
**Sada troch keramických nožov v praktickom stojane**

 260 x 130 x 80 mm  
tampoprint, sieťotlač

ks	1-4	5+	25+	50+
€	33,435	32,174	31,043	30,304

**Brúska na nože Victorinox s keramickými kolieskami**

 200 x 55 x 65 mm/205 x 65 x 55 mm (box)  
tampoprint

ks	1-9	10+	50+	100+
€	24,435	23,174	22,348	21,565

**novinka**

dve polohy nastavenia uhlu brúsnych koliesok podľa sklonu ostria noža

**90493.R**

**90494.C**

**VICTORINOX**

**90589.Q**
**Trojdielna sada nožov VICTORINOX v darčekovom balení**

 275 x 110 x 20 mm (box)  
tampoprint, laserový popis

ks	1-9	10+	50+	100+
€	17,913	17,000	16,391	15,783

**51172.Q**
**Sada nožov s oceľovou čepeľou v japonskom štýle**

 370 x 140 x 28 mm (box)  
tampoprint, laserový popis

ks	1-19	20+	100+	200+
€	9,565	9,217	8,913	8,696



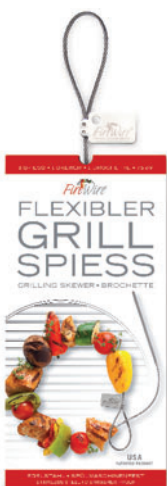

**91880.S**  
Flexibilný grilovací špíz  
FireWire® Single

dĺžka špízu 750 mm, 100 x 207 mm  
laserový popis

ks	1-29	30+	150+	300+
€	5,348	5,174	5,000	4,826



**BRAIN STREAM**

Designed in Germany

novinka

vyrobený zo špeciálnej  
nerezovej ocele

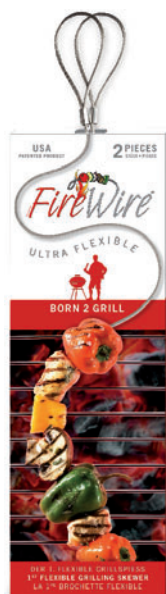

**91881.S**  
Flexibilný grilovací špíz  
FireWire® Double

dĺžka špízu 750 mm, 100 x 300 mm  
laserový popis

ks	1-19	20+	100+	200+
€	9,000	8,783	8,565	8,391



**16286.Q**  
Pikniková deka v čiernej taške  
s PVC izolačnou vrstvou

380 x 280 x 50 mm (zložená)  
1500 x 1175 mm (rozložená)  
sietotlač, transfer

ks	1-9	10+	50+	100+
€	15,878	14,898	14,367	14,041

praktická izolačná vrstva zabráni  
peniknutiu vlhkosti a chráni deku  
pred zašpinením



novinka



**16155.Q**  
Grilovacia sada BBQ-Caddy  
v golfovom vaku – 7 dielov

90 x 500 x 160 mm  
transfer (obal)

ks	1-4	5+	25+	50+
€	39,306	36,898	35,551	34,735

novinka



**Bavlnená zástera**

650 x 900 mm  
bavlna 180 g/m<sup>2</sup>  
sietotlač, transfer, výšivka

ks	1-59	60+	300+	600+
€	3,687	3,548	3,422	3,343



**51159.Q**  
Pikniková deka  
s praktickým držadlom

1300 x 1900 mm  
výšivka (deka)  
sietotlač, laser (držadlo)

ks	1-14	15+	75+	150+
€	12,609	12,174	11,739	11,435

novinka



51152.C

51153.B

51154.Z

**16153.Q****Grilovacia sada Grillino – 3 diely**370 x 110 x 80 mm (box)  
tampoprint, laserový popis

ks	1-9	10+	50+	100+
€	16,735	15,714	15,143	14,776

**16151.Q****Veľká grilovacia sada Grillmeister – 21 dielov**471 x 290 x 75 mm (box)  
tampoprint, laserový popis

ks	1-2	3+	15+	30+
€	59,020	55,347	53,388	52,122

**35703.Q****Veľká grilovacia súprava – 12 dielov**480 x 200 x 85 mm (box)  
tampoprint, laserový popis

ks	1-4	5+	25+	50+
€	38,261	36,826	35,522	34,696

**16159.Q****Servirovacia sada na porcovanie mäsa – 3 diely**336 x 140 x 35 mm (box)  
tampoprint, laserový popis

ks	1-7	8+	40+	80+
€	27,469	25,796	24,857	24,286





novinka

**30324.M**  
Skladací piknikový  
kôš s termovreckom  
a vybavením pre dvoch

460 x 260 x 220 mm  
polyester 600D  
sietotlač, transfer

ks	1-4	5+	25+	50+
€	40,739	39,217	37,826	36,957



Obsahuje: 2 poháre na víno z tvrdého plastu,  
2 melaminové taniere, 2 sady kovových  
príborov (nože, vidličky, lyžičky), 1 podložka  
na krájanie, 1 otvárač a 2 bavlnené utierky.

**16283.C**

Multifunkčná dobíjacia  
lampa Transformer s dvomi  
odnímateľnými baterkami

Ø 126 x 255 mm  
tampoprint

ks	1-3	4+	20+	40+
€	56,939	53,429	51,510	50,286



Táto úžasná multifunkčná 70x LED lampa osvetlí  
vaše okolie všetkými smermi. Variabilné napájanie  
dobíjateľnej hlavnej batérie (6V/4Ah) z 220V zásuvky  
či 12V zdroja (napr. automobilová zásuvka zapalovača).

**16165.H**

Pikniková taška 4 PICKNICK  
s dekou a bohatou výbavou

500 x 270 x 250 mm  
sietotlač, transfer

ks	1-3	4+	20+	40+
€	50,245	47,143	45,429	44,367

**30316.M**2 nové  
farby**30320.B****30318.M**

Veľká termotaška  
s vreckami

195 x 270 x 145 mm  
polyester 600D  
sietotlač, transfer

ks	1-19	20+	100+	200+
€	11,739	11,304	10,913	10,652



30317.C



30319.R





30510.Q

Farebná sada štyroch keramických šálok na cappuccino v darčekovom boxe

novinka

200 ml (šálka), 440 x 145 x 100 mm (box)  
tampoprint (šálky), laserový popis (štitok boxu)

ks	1-9	10+	50+	100+
€	19,739	19,000	18,304	17,913



28322.B

Sada dvoch šálok na espresso s lyžičkami

220 x 160 x 60 mm (box)  
tampoprint

ks	1-14	15+	75+	150+
€	13,000	12,565	12,174	11,913



28325.Q

Sada šiestich šálok na espresso

142 x 125 x 11 mm (box)  
tampoprint

ks	1-19	20+	100+	200+
€	9,913	9,565	9,217	9,000



28340.B

Sada keramickej kanvičky a šálky na čaj v čiernom darčekovom boxe

400 ml (kanvička)  
165 x 110 x 135 mm (box)  
tampoprint

ks	1-19	20+	100+	200+
€	10,217	9,870	9,478	9,261





51158.S

Štvordielna sada na víno  
v kovovom boxe180 x 110 x 40 mm (box)  
tampoprint, laserový popis

ks	1-29	30+	150+	300+
€	7,565	7,304	7,043	6,870



30507.Q

Jednopáková vývrtka na víno

160 x 210 x 63 mm (box)  
tampoprint, laserový popis

ks	1-9	10+	50+	100+
€	18,478	17,826	17,174	16,783

52237.V

Štvordielna sada na víno

Ø 156 x 44 mm  
tampoprint, laserový popis

ks	1-14	15+	75+	150+
€	13,391	12,913	12,435	12,130



42980.P

Dvojdielna sada na víno

112 x 160 x 48 mm (box)  
tampoprint

ks	1-19	20+	100+	200+
€	8,652	8,217	7,783	7,348

52238.S

Sada otvárací a zátky na víno  
v darčekovom boxe139 x 114 x 25 mm (box)  
tampoprint, laserový popis

ks	1-59	60+	300+	600+
€	3,196	3,078	2,970	2,900





30504.V

Deväťdielna sada na víno  
v drevenom boxe280 x 250 x 65 mm (box)  
tampoprint, laserový popis

ks	1-4	5+	25+	50+
€	36,957	35,609	34,348	33,522



42982.S

Päťdielna sada na víno

190 x 197 x 50 mm (box)  
tampoprint

ks	1-19	20+	100+	200+
€	10,739	9,913	9,217	8,609



42981.S

Štvordielna sada na víno

140 x 173 x 48 mm (box)  
tampoprint

ks	1-24	25+	125+	250+
€	8,609	7,957	7,391	6,913



51174.TJ

Chladiaca nádoba na víno z lesklého  
šedého transparentného plastu

Ø 140 x 210 mm

ks	1-39	40+	200+	400+
€	6,261	6,043	5,826	5,696



16042.C

Nádoba na chladenie vína Cooler

125 x 255 x 120 mm  
tampoprint, laserový popis

ks	1-19	20+	100+	200+
€	10,816	10,163	9,796	9,551



novinka

16284.S

Nerezový držiak  
na fľašu vína SteadyØ 78 x 235 mm  
tampoprint, laserový popis

ks	1-29	30+	150+	300+
€	6,857	6,449	6,204	6,082



42770.S

Sada dezertnej vidličky a lyžičky

168 x 78 x 25 mm (box)  
tampoprint, laserový popis

ks	1-199	200+	1000+	2000+
€	0,735	0,691	0,648	0,604



42960.S

Box na víno s príslušenstvom (bez fľaše)

360 x 110 x 112 mm (box)  
laserový popis

ks	1-14	15+	50+	100+
€	12,565	11,696	10,609	9,957





42975.H

Box na víno s príslušenstvom (bez fľaše)

360 x 122 x 112 mm (box)  
tampoprint

ks	1-14	15+	75+	150+
€	15,087	13,957	12,957	12,087

30521.C

Dvojdielna sada na víno  
v čiernom unikátnom boxe140 x 110 x 32 mm (box)  
tampoprint, laserový popis

ks	1-39	40+	200+	400+
€	6,130	5,913	5,696	5,565



16285.Q

Sada na víno Pleasure  
v praktickom drevenom stojane60 x 148 x 60 mm (stojan)  
tampoprint, laserový popis

ks	1-19	20+	100+	200+
€	12,204	11,429	11,020	10,776



30522.C

Štvordielna sada na víno  
v čiernom unikátnom boxe155 x 155 x 32 mm (box)  
tampoprint, laserový popis

ks	1-29	30+	150+	300+
€	8,609	8,304	8,000	7,826



Veľký transparentný  
plastový pohár

novinka

400 ml  
Ø 89 x 100 mm  
tampoprint

ks	1-129	130+	650+	1300+
€	1,470	1,413	1,365	1,330

51911.TM



51912.TZ



51914.TO

51913.TJ



90401.T

Frosty pohár Londýn  
s hrubým dnom250 ml, balenie 6 ks  
Ø 60 x 132 mm  
tampoprint, rotačná sietotlač

ks	6-119	120+	360+	1200+
€	1,430	1,300	1,257	1,213



90405.T

## Whisky pohár s hrubým dnom

200 ml, balenie 6 ks  
Ø 72 x 87 mm  
tampoprint, pieskovanie, rotačná sietotlač

ks	6-119	120+	480+	1200+
€	1,083	0,996	0,952	0,909

60334.T

## Frosty panákovka

50 ml, balenie 12 ks  
Ø 44 x 70 mm  
tampoprint

ks	12-599	600+	2400+	6000+
€	0,430	0,396	0,370	0,343



60331.T

## Frosty hrnček

300 ml  
Ø 80 x 95 mm  
rotačná sietotlač, tampoprint

ks	1-479	480+	1200+	3600+
€	0,848	0,800	0,743	0,691



90400.T

Pohár Londýn  
s hrubým dnom300 ml, balenie 6 ks  
Ø 60 x 165 mm  
tampoprint, pieskovanie, rotačná sietotlač

ks	6-119	120+	480+	1200+
€	1,083	0,996	0,952	0,909





30508.T

Sada 3 pohárov  
z recyklovaného skla  
JAMIE OLIVER

novinka

300 ml  
Ø 80 x Ø 58 x 125 mm  
tampoprint, pieskovanie

ks	1-14	15+	75+	150+
€	14,870	14,348	13,826	13,478

Green

Jamie  
Oliver®



30509.T

Sada karafy na vodu a pohára  
z recyklovaného skla JAMIE OLIVER

novinka

275 x 180 x 95 mm (box)  
karafa 1l / pohár 300 ml  
tampoprint, pieskovanie

ks	1-9	10+	50+	100+
€	16,522	15,913	15,348	15,000

60342.T

Poháre na červené víno 590 ml

590 ml, balenie 6 ks  
Ø 95 mm x 220 mm  
tampoprint, pieskovanie

ks	6-99	100+	500+	1000+
€	1,717	1,665	1,630	1,604



60341.T

Poháre na biele víno 350 ml

350 ml, balenie 6 ks  
Ø 79 mm x 200 mm  
tampoprint, pieskovanie

ks	6-99	100+	500+	1000+
€	1,587	1,535	1,500	1,457



30270.T

Karafa  
z recyklovaného skla

Green

800 ml  
Ø 100 x 250 mm  
tampoprint, pieskovanie

ks	1-19	20+	100+	200+
€	12,261	11,826	11,391	11,130





80470.B

Klasický hrnček  
z porcelánu

novinka

300 ml, Ø 79 x 93 mm  
rotačná sietotlač, tampoprint

ks	1-99	100+	500+	1000+
€	1,870	1,783	1,735	1,674



80469.Z

Keramikový hrnček  
s farebnými prúžkami

novinka

200 ml  
Ø 68 x 80 mm  
tampoprint

ks	1-149	150+	750+	1500+
€	1,113	1,070	1,026	1,000



80468.M

80467.R

60102.B

Čajová šálka z jemného porcelánu

190 ml, balenie 12 ks  
tampoprint

ks	12-99	100+	500+	1000+
€	2,013	1,861	1,726	1,613



60100.B

Mocca kávová šálka  
z jemného porcelánu75 ml, balenie 12 ks  
tampoprint

ks	12-119	120+	600+	1200+
€	1,300	1,213	1,117	1,022

60101.B

Kávová šálka z jemného porcelánu

150 ml, balenie 12 ks  
tampoprint

ks	12-119	120+	600+	1200+
€	1,909	1,778	1,670	1,561



51165.R

51164.M

51166.O

Dvojfarebná nerezová fľaša  
s karabínou a gumovým pásikom750 ml  
Ø 72 x 266 mm  
tampoprint, laserový popis

ks	1-39	40+	200+	400+
€	5,087	4,870	4,696	4,609



42696.M

42698.S

42697.R

Kovová fľaša na nápoje

600 ml  
Ø 70 x 210 mm  
tampoprint, laserový popis, rotačná sietotlač

ks	1-59	60+	300+	600+
€	3,230	3,109	3,000	2,930



**Dvojfarebný keramický hrnček v krabičke**
**novinka**

 250 ml  
 Ø 73 x 95 mm  
 tampoprint

ks	1-79	80+	400+	800+
€	2,400	2,309	2,226	2,174



51917.J



51916.R



51915.M

**andré philippe**
**80466.Q**
**Veľký keramický hrnček s čiernobiou dekoráciou André Philippe**
**novinka**

 350 ml, Ø 79 x 125 mm  
 tampoprint

ks	1-99	100+	500+	1000+
€	1,891	1,804	1,735	1,691

**Keramický pohárik so silikónovým pásom a viečkom**

 400 ml  
 Ø 90 x 120 mm  
 tampoprint

ks	1-39	40+	200+	400+
€	4,913	4,696	4,565	4,435



51909.Z

**2 nové farby**

51910.C



51907.J



51905.M



51906.R



51908.O

**80465.B**
**Veľký keramický hrnček**

 400 ml  
 Ø 80 x 130 mm  
 tampoprint

ks	1-99	100+	500+	1000+
€	1,848	1,761	1,691	1,648



51332.M



51333.B

51334.O

**Módny hrnček**

 300 ml  
 Ø 80 x 100 mm  
 tampoprint

ks	1-89	90+	450+	900+
€	2,365	2,278	2,196	2,148

**Dvojfarebný keramický hrnček s lyžičkou**250 ml  
Ø 115 x 120 mm  
tampoprint

ks	1-79	80+	400+	800+
€	2,483	2,387	2,304	2,248



51163.O



51160.M



51161.Y



51162.Z



51336.M

**Keramický hrnček s lyžičkou v ušku**300 ml  
Ø 94 x 122 mm  
tampoprint

ks	1-79	80+	400+	800+
€	2,578	2,483	2,391	2,339



51339.Z



51338.O

**Papierový box na hrnček**110 x 110 x 85 mm  
sietotlač

ks	1-299	300+	1500+	3000+
€	0,604	0,565	0,535	0,517

90320.M



90300.B

Boxy na hrnčeky sú dodávané  
v nezloženom stave.**38422.C****Matný keramický hrnček**300 ml  
Ø 80 x 95 mm  
tampoprint, rotačná sietotlač

ks	1-79	80+	400+	800+
€	2,448	2,357	2,274	2,222

na hrnček je možné písať kriedou  
(súčasť balenia)



60310.B  
biely

ks	1-179	180+	600+	1200+
€	1,039	0,974	0,926	0,874



60309.R  
červeno-biely

ks	1-179	180+	600+	1200+
€	1,300	1,213	1,143	1,087

60307.C  
matný čierny



60308.R  
matný gaštanový



ks	1-179	180+	600+	1200+
€	1,300	1,213	1,143	1,087



60311.M  
modrý Cobalt Blue



60305.M  
modro-biely

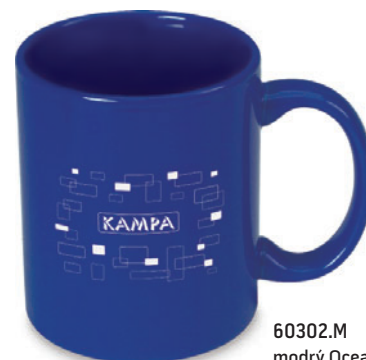

60302.M  
modrý Ocean Blue



60303.Z  
zelený



60306.Y  
žltý

ks	1-179	180+	600+	1200+
€	1,170	1,087	1,030	0,996



60304.J  
svetlo šedý



# Fľašky, termosky, termohrnčeky

29074.0



29073.M

Nerezová termošálka s farebným plastovým viečkom a uškom

400 ml  
Ø 81 x 165 mm  
tampoprint, laserový popis

ks	1-59	60+	300+	600+
€	3,657	3,522	3,396	3,317

29075.C



29076.S

Kovová termokanvička do auta s dvojitou stenou

400 ml  
Ø 88 x 145 mm  
tampoprint, laserový popis

ks	1-49	50+	250+	500+
€	4,096	3,943	3,800	3,713



42733.S

Dvojdielna kovová termokanvička

kanvička 400 ml, šálka 200 ml  
Ø 80 x 197 mm  
tampoprint, laserový popis

ks	1-29	30+	150+	300+
€	5,348	4,957	4,565	4,278



42693.M



42694.R

42691.B



Termohrnček

330 ml  
Ø 85 x 170 mm  
tampoprint

ks	1-69	70+	350+	700+
€	2,883	2,661	2,470	2,304



42718.S

Kovový hrnček s dvojitou stenou

300 ml  
 Ø 76 x 90 mm  
 tampoprint, laserový popis

ks	1-49	50+	250+	500+
€	3,870	3,652	3,435	3,217



Nerezový termohrnček  
 s plastovou úchopovou časťou

novinka

370 ml  
 Ø 70 x 215 mm  
 tampoprint, laserový popis

ks	1-39	40+	200+	400+
€	5,837	5,469	5,265	5,143



16190.B



16191.M



16192.R

42702.S

Kovová termošálka s dvojitou  
 stenou a praktickým viečkom

330 ml  
 Ø 73 x 93 mm  
 tampoprint, laserový popis

ks	1-49	50+	250+	500+
€	3,878	3,583	3,326	3,104



42731.S

Kovová šálka s dvojitou  
 stenou a podšálkou

200 ml  
 Ø šálky 76 x 75 mm  
 Ø podšálky 140 mm  
 tampoprint, laserový popis

ks	1-49	50+	250+	500+
€	3,870	3,652	3,435	3,217



42740.M

Hrnček s dvojitou stenou

200 ml  
 Ø 68 x 83 mm  
 tampoprint

ks	1-99	100+	500+	1000+
€	2,126	1,961	1,822	1,700



42732.C

42719.S

Kovový hrnček  
 s dvojitou stenou

330 ml  
 Ø 77 x 95 mm  
 tampoprint, laserový popis

ks	1-79	80+	400+	800+
€	2,574	2,374	2,204	2,061





**Kovová termoska s gumovým úchytom**

500 ml  
 Ø 75 x 270 mm  
 tampoprint, laserový popis

ks	1-19	20+	100+	200+
€	9,609	9,261	8,957	8,739



28347.S

28346.R



28345.M



16166.C



16168.M



16167.R



**Kovová termofľaša Kegel**

500 ml  
 Ø 75 x 257 mm  
 tampoprint, laserový popis

ks	1-19	20+	100+	200+
€	11,673	10,939	10,571	10,327

42700.S

**Kovová termoska s veľkou šálkou**

600 ml, šálka 300 ml  
 Ø 75 x 268 mm  
 tampoprint, laserový popis

ks	1-29	30+	150+	300+
€	6,913	6,391	6,043	5,696



42708.S

**Kovová termoska v obale**

750 ml  
 Ø 77 x 280 mm  
 tampoprint, laserový popis, rotačná sietotlač

ks	1-29	30+	150+	450+
€	7,783	7,435	7,174	6,913



42706.S

**Kovová termoska**

500 ml  
 Ø 70 x 240 mm  
 tampoprint, laserový popis, rotačná sietotlač

ks	1-29	30+	100+	200+
€	6,043	5,783	5,609	5,435





42728.S

Sada štyroch kalíškov

4 x 33 ml (kalíšky)  
 Ø 45 x 70 mm (puzdro)  
 tampoprint, laserový popis

ks	1-49	50+	100+	300+
€	4,130	3,913	3,696	3,478



42717.G

Veľká zlatá fľaška

240 ml  
 92 x 141 x 24 mm  
 tampoprint, laserový popis

ks	1-29	30+	100+	200+
€	6,913	6,609	6,348	6,130

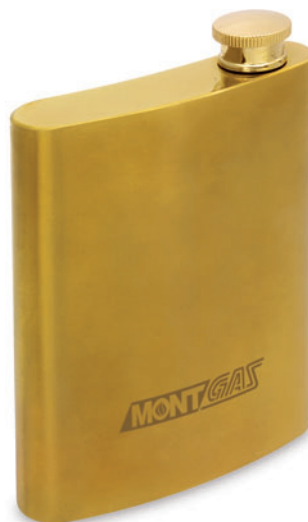

42713.S

Kovová fľaška so „saténovým“ povrchom

180 ml  
 90 x 105 x 25 mm  
 tampoprint, laserový popis

ks	1-29	30+	100+	200+
€	6,913	6,609	6,348	6,130



42752.S

Kovová fľaška s 3 kalíškami

200 ml  
 90 x 145 x 25 mm  
 tampoprint, laserový popis

ks	1-29	30+	100+	300+
€	7,348	7,000	6,739	6,478



42727.S

Lesklá kovová fľaška s priezorom

180 ml  
 90 x 105 x 25 mm  
 tampoprint, laserový popis

ks	1-29	30+	100+	200+
€	6,913	6,609	6,348	6,130



42736.S

Kovová fľaška s vodorovným pásikom

225 ml  
 97 x 123 x 23 mm  
 tampoprint, laserový popis

ks	1-29	30+	150+	300+
€	7,783	7,174	6,652	6,217



42739.S

Kovová fľaška so zvislým pásikom

225 ml  
 97 x 123 x 23 mm  
 tampoprint, laserový popis

ks	1-29	30+	150+	300+
€	7,783	7,174	6,652	6,217





**42757.S**  
Kovová fľaška  
dekorovaná štvorčkami

210 ml  
95 x 120 x 22 mm  
tampoprint, laserový popis

ks	1-29	30+	150+	300+
€	7,783	7,174	6,652	6,217

**42754.S**  
Kovová fľaška  
dekorovaná bodkami



**42756.S**  
Kovová fľaška dekorovaná bodkami  
s 2 kalíškami a lievikom v darčekovom balení



210 ml  
205 x 160 x 50 mm (box)  
tampoprint, laserový popis

ks	1-19	20+	100+	200+
€	14,739	13,913	13,130	12,435



**42711.S**  
Matná kovová fľaška

200 ml  
95 x 122 x 22 mm  
tampoprint, laserový popis

ks	1-29	30+	100+	200+
€	6,913	6,609	6,348	6,130



**42755.S**  
Kovová fľaška  
dekorovaná bodkami  
v darčekovom balení

210 ml  
110 x 145 x 30 mm (box)  
tampoprint, laserový popis

ks	1-19	20+	100+	200+
€	9,348	8,652	8,087	7,609



**42759.S**  
Kovová fľaška dekorovaná štvorčkami  
s 2 kalíškami a lievikom v darčekovom balení



**42758.S**  
Kovová fľaška  
dekorovaná štvorčkami  
v darčekovom balení





42745.C

Kovová fľaška obšitá pravou kožou v darčekovom balení

210 ml  
110 x 145 x 30 mm (box)  
tampoprint, laserový popis

ks	1-19	20+	100+	200+
€	11,522	10,913	10,348	9,957



42748.H

42749.H

Kovová fľaška obšitá pravou kožou s 2 kalíškami a lievikom v darčekovom balení

210 ml  
205 x 160 x 50 mm (box)  
tampoprint, laserový popis

ks	1-19	20+	100+	200+
€	16,913	16,174	15,391	14,783



42737.S

Kovová fľaška s vodorovným pásikom v darčekovom balení

ks	1-19	20+	100+	200+
€	9,348	8,652	8,087	7,609



110 x 145 x 30 mm (box)  
tampoprint, laserový popis

42720.S

Matná kovová fľaška v darčekovom balení

ks	1-24	25+	100+	200+
€	8,478	8,087	7,783	7,522



42738.S

Kovová fľaška s vodorovným pásikom, s 2 kalíškami a lievikom v darčekovom balení

ks	1-19	20+	100+	200+
€	14,739	13,913	13,130	12,435



225 ml  
205 x 160 x 50 mm (box)  
tampoprint, laserový popis



42722.S

Matná kovová fľaška s 2 kalíškami a lievikom v darčekovom balení

ks	1-19	20+	100+	200+
€	13,870	13,348	12,826	12,348



42744.C  
hladký povrch kože

42747.H  
štruktúrovaný povrch kože

Kovová fľaška obšitá pravou kožou

210 ml  
95 x 123 x 22 mm  
tampoprint, laserový popis

ks	1-19	20+	100+	200+
€	9,957	9,435	8,913	8,565





# Zapaľovače, popolníky



**42769.S**  
Orezávač cigár  
v čiernom koženom puzdre

89 x 39 x 4 mm  
tampoprint, laserový popis

ks	1-49	50+	200+	400+
€	3,470	3,200	2,974	2,774



**60127.S**

Zapaľovač s vlastným popolníkom

80 x 37 x 12 mm  
tampoprint

ks	1-49	50+	250+	500+
€	4,048	3,778	3,543	3,335

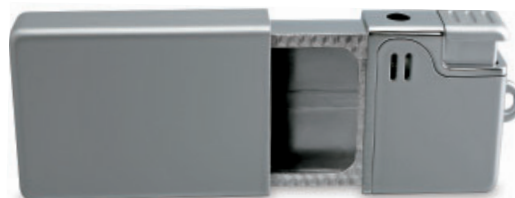

**60126.S**

Kovový zapaľovač  
v príviesku

40 x 70 x 9 mm  
tampoprint, laserový popis

ks	1-49	50+	250+	500+
€	4,304	4,130	3,957	3,765



**60112.C**

Sklenený popolník

108 x 108 x 37 mm  
tampoprint

ks	1-99	100+	500+	1000+
€	1,791	1,652	1,535	1,430



**80210.TB**

Sklenený frosty popolník

Ø 105 x 35 mm  
tampoprint

ks	1-149	150+	750+	1500+
€	1,326	1,270	1,222	1,191



**60110.B**

Porcelánový popolník

Ø 90 mm  
tampoprint

ks	1-99	100+	500+	1000+
€	1,535	1,413	1,313	1,226

**80213.TZ**



**80212.TM**



**80211.TR**

Všetky zapaľovače, pri ktorých to predpisy EU vyžadujú, sú vybavené detskými poistkami.





16179.S

Flexibilný krbový zapaľovač  
Flex light210 x 27 x 15 mm  
tampoprint, laserový popis

ks	1-29	30+	150+	300+
€	6,490	6,082	5,878	5,714

16189.S

Extra dlhý kovový grilový  
zapaľovač s očkom na zavesenie

novinka

29 x 482 x 23 mm  
tampoprint, laserový popis

ks	1-19	20+	100+	200+
€	11,714	11,020	10,612	10,367

293 mm dlhý krk



60219.S

60216.C

Elegantný krbový zapaľovač

220 x 30 x 40 mm  
tampoprint, laserový popis

ks	1-39	40+	200+	400+
€	5,913	5,522	5,174	4,870



60214.C

60213.B

Krbový zapaľovač

205 x 50 x 23 mm  
tampoprint

ks	1-199	200+	800+	1600+
€	1,126	1,052	0,987	0,926

60215.S

Krbový zapaľovač so stojanom  
v darčekovej krabičke175 x 15 x 11 mm (zapaľovač)  
34 x 34 mm (stojan)  
tampoprint, laserový popis

ks	1-49	50+	250+	500+
€	4,104	3,830	3,591	3,378



60217.S

60218.C

Barbecue zapaľovač  
v darčekovej krabičke205 x 23 x 14 mm  
tampoprint

ks	1-39	40+	200+	400+
€	4,826	4,478	4,217	3,970



16173.S

Luxusný oceľový zapaľovač Comte v darčekovej krabičke

70 x 33 x 11 mm (zapaľovač)  
93 x 93 x 30 mm (krabička)  
tampoprint, laserový popis

ks	1-9	10+	50+	100+
€	18,531	17,388	16,776	16,367



16176.M

Kovový zapaľovač Azzurra

63 x 32 x 9 mm  
tampoprint, laserový popis

ks	1-39	40+	200+	400+
€	5,878	5,510	5,306	5,184

LED signalizácia zásoby plynu



60113.B



60114.C



Kovový plniteľný piezo zapaľovač s turboplameňom

27 x 71 x 7 mm  
tampoprint, laserový popis

ks	1-59	60+	300+	600+
€	3,457	3,265	3,061	2,883

zelený turboplameň



60116.C



60115.S



Kovový plniteľný piezo zapaľovač s turboplameňom

28 x 62 x 7 mm  
tampoprint, laserový popis

ks	1-49	50+	300+	600+
€	3,691	3,443	3,230	3,039

zelený turboplameň

Kovový plniteľný piezo zapaľovač

30 x 65 x 10 mm  
tampoprint, laserový popis

ks	1-49	50+	250+	500+
€	3,609	3,370	3,157	2,974



60128.S

Benzínový zapaľovač s lesklým chrómovaným povrchom

36 x 56 x 12 mm  
tampoprint, laserový popis

ks	1-99	100+	500+	1000+
€	1,817	1,696	1,591	1,496



60124.S



60125.C

Všetky zapaľovače, pri ktorých to predpisy EU vyžadujú, sú vybavené detskými poistkami.





## Kovový plniteľný piezo zapaľovač

22 x 78 x 10 mm  
tampoprint, laserový popis

ks	1-49	50+	300+	600+
€	2,591	2,417	2,265	2,130

60185.M      60186.S      60187.R      60188.C



60117.S

60118.M

60119.B

Piezo zapaľovač  
na sviečky alebo fajky

novinka

30 x 105 x 14 mm  
tampoprint

ks	1-299	300+	1500+	3000+
€	0,717	0,670	0,630	0,591

60199.S      60195.B      60197.C      60198.M

Plniteľný piezo zapaľovač  
s LED svetlom

24 x 81 x 11 mm  
tampoprint

ks	1-299	300+	1500+	3000+
€	0,548	0,513	0,478	0,452

60138.C      60137.S



## Kovový plniteľný piezo zapaľovač

20 x 82 x 9 mm  
tampoprint, laserový popis

ks	1-49	50+	250+	500+
€	3,870	3,652	3,422	3,222

60181.C      60182.S      60183.TM

Plniteľný zapaľovač  
s LED svetlom

25 x 80 x 10 mm  
tampoprint

ks	1-299	300+	1500+	3000+
€	0,626	0,583	0,548	0,513



60122.S

60123.C

## Plniteľný piezo zapaľovač ZORR

30 x 60 x 15 mm  
tampoprint, laserový popis

ks	1-69	70+	350+	700+
€	2,922	2,726	2,557	2,404



60176.S



**Plnitelný piezo zapaľovač**

25 x 83 x 10 mm  
tampoprint

ks	1-499	500+	3000+	6000+
€	0,370	0,343	0,322	0,300

60170.B



60171.C



60172.R



60173.M



60174.Y



60175.Z



60133.M



60130.B



60131.C



60132.R



60134.Y



60135.Z



**Jednorazový kamienkový zapaľovač**

25 x 82 x 12 mm  
tampoprint

ks	1-999	1000+	5000+	10000+
€	0,196	0,178	0,170	0,161

**Plnitelný piezo zapaľovač**

25 x 80 x 9 mm  
tampoprint

ks	1-499	500+	3000+	6000+
€	0,387	0,365	0,343	0,326

60166.S



60160.B



60161.C



60162.R



60163.M



60164.Y



60165.Z



60167.O



60168.M



modrá metalíza

Všetky zapaľovače, pri ktorých to predpisy EU vyžadujú, sú vybavené detskými poistkami.



**Plniteľný piezo zapaľovač  
s otváradom**

 25 x 80 x 10 mm  
tampoprint

ks	1-499	500+	3000+	6000+
€	0,413	0,387	0,361	0,339

60220.B



60221.C



60222.R



60223.M



60224.Y



60230.B



60231.C



60232.R



60233.M



60234.Y



60236.S

**Plniteľný piezo zapaľovač  
s turboplameňom**

 25 x 79 x 12 mm  
tampoprint

ks	1-499	500+	3000+	6000+
€	0,430	0,409	0,383	0,361

 pre pohodlné  
zapaľovanie  
vo vetre aj mraze

**Matný plniteľný piezo zapaľovač**

 25 x 78 x 10 mm  
tampoprint

ks	1-499	500+	3000+	6000+
€	0,409	0,383	0,361	0,339

60190.B



60191.C



60192.R



60193.M



60194.Y



60196.S



60153.M

60150.B



60151.C



60152.R



60154.Y

**Plniteľný mini piezo zapaľovač**

 24 x 62 x 9 mm  
tampoprint

ks	1-499	500+	3000+	6000+
€	0,335	0,313	0,291	0,274



# Šnúrky na krk



80354.M

## Šnúrka na krk s karabínou

20 x 450 mm  
sietotlač, transfer

ks	1-499	500+	2500+	5000+
€	0,404	0,387	0,374	0,361



nová  
farba

80356.C



80350.B



80351.Y



80352.O



80355.Z



80353.R

novinka

90680.X

## Šnúrka na krk s karabínou a plnofarebnou sublimačnou tlačou

15 x 450 mm  
sublimačná tlač

ks	cena €/ks
50–99 ks	2,130
100–199 ks	2,017
200–299 ks	1,900
300–499 ks	1,861
500 a viac ks	1,800
Technická príprava	paušál 13,043

Cena je uvedená vrátane obojstrannej sublimačnej tlače (digitálna potlač ľubovoľným počtom farieb).

Iné šírky šnúrok či iné koncovky vám radi vykalkulujeme na dopyt. Termín dodania cca 14 dní (od schválenia korektúry).

Príplatok za spojovací klip (trojzubeček): +0,50 €/ks, príplatok za šnúrku na mobil: +0,14 €/ks.



35876.M



## Šnúrka na krk s karabínou, klipom a poistkou

25 x 480 mm  
sietotlač, transfer

ks	1-199	200+	1000+	2000+
€	0,796	0,765	0,739	0,722

35870.O



35872.R



35873.Z



35877.B



35878.C







Šnúrka na krk s karabínou,  
odpojiteľným pútkom  
na mobil a klipom

novinka

20 x 550 mm  
sieťotlač, transfer

ks	1-299	300+	1500+	3000+
€	0,596	0,570	0,548	0,535

80315.0



80313.B



80317.M

80314.Y



80318.Z

80316.R



80319.C



20728.M

Rolovací klip  
na menovky a karty

Ø 30 x 80 mm  
tampoprint

ks	1-499	500+	2500+	5000+
€	0,422	0,409	0,391	0,383

Puzdra na karty nájdete  
na nasledujúcej strane pod  
objednávacím kódom 90798.X



80359.Y

Reflexná šnúrka na krk s karabínou,  
pútkom na mobil a klipom

20 x 500 mm  
transfer

ks	1-149	150+	750+	1500+
€	1,557	1,496	1,435	1,400



33992.TM



33993.TB



Roller klip – privesok s navijákom

55 x 35 x 7 mm  
tampoprint

ks	1-99	100+	500+	1000+
€	1,543	1,487	1,435	1,400

nová  
farba

33994.TC



Šnúrky na krk (potlač podľa počtu kusov a farieb vid' ceny dotlače šnúrok)					
1. časť kódu	prevedenie	od 500 ks	od 1000 ks	od 3000 ks	od 5000 ks
9071*	šírka 10 mm spletaná, dĺžka cca 90 cm	0,486	0,392	0,355	0,331
9072	šírka 12 mm spletaná, dĺžka cca 90 cm	0,522	0,433	0,392	0,363
9073	šírka 15 mm plochá, dĺžka cca 90 cm	0,567	0,518	0,469	0,396
9074	šírka 15 mm plochá s klipom, dĺžka cca 100 cm	0,751	0,706	0,649	0,580
9075	šírka 20 mm plochá, dĺžka cca 90 cm	0,596	0,543	0,490	0,420
9076	šírka 20 mm plochá s klipom, dĺžka cca 100 cm	0,771	0,722	0,669	0,592
9077	šírka 25 mm plochá, dĺžka cca 100 cm	0,669	0,612	0,555	0,457

\* šnúrky 9071 možno dodať i v šírkach 6 mm alebo 8 mm, za rovnakú cenu

uvedené dĺžky šnúrok sú približné



907xx.x  
Šnúrky na krk  
od 0,331

Príklady zostavenia objednacieho kódu:

- šírka 12 mm dĺžka 90 cm so štandardným krúžkom, modrá farba: 90721.M
- šírka 15 mm s klipom, s karabínkou rybie oko, červená farba: 90746.R

Ceny pri viac ako 10 000 ks na vyžiadanie.

3. časť kódu	farba	odtieň podľa Pantone
.B	biela	–
.Y	žltá	Yellow C
.O	oranžová	021 C
.R	červená	032 C
.M	modrá	Reflex Blue
.Z	zelená	343 C
.C	čierna	–
.X	vlastná	podľa zadania

	Ceny reklamnej dotlače spletaných a plochých šnúrok na krk			
	jedna farba	dve farby	tri farby	štyri farby
500–999 ks	0,229	0,457	0,518	0,641
1 000–2 999 ks	0,163	0,245	0,335	0,457
3 000–4 999 ks	0,114	0,180	0,200	0,351
5 000 a viac ks	0,082	0,147	0,184	0,290
obojsmerná tlač	+0,078 €/ks	+0,131 €/ks	+0,147 €/ks	+0,163 €/ks
technická príprava	16 €	33 €	49 €	65 €

Ak nie je uvedené inak, sú logá tlačené ako nekonečná tlač, akékoľvek iné umiestnenie tlače na dopyt a za príplatok, špecifikácie umiestnenia +0,030 €/ks.



90800.X  
záves k plastovému puzdru na identifikačnú kartu (pre samostatné objednávky)  
0,118

90798.X  
puzdro na identifikačnú kartu bez závesu (pre samostatné objednávky)  
104 x 84 mm  
0,237



2. časť kódu – voliteľné koncovky:

1  
krúžok  
+ 0,004



2  
záves na menovky  
+ 0,094



3  
pútko na mobil  
+ 0,118



4  
odpojiteľné pútko na mobil  
+ 0,094



5  
karabína s poistkou  
+ 0,114



6  
karabína rybie oko  
+ 0,159



7  
klip – spojka naviac k pevnej šnúrke  
+ 0,147



8  
záves s puzdrom na identifikačnú kartu (pre objednávky vrátane šnúrok)  
+ 0,237



Reklamné cukríky točené 3,5 g v bielej twist fólii (cena za 1 kg)								
kód	popis tovaru	potlač	od 25 kg	od 50 kg	od 100 kg	od 200 kg	od 300 kg	od 500 kg
90411.B	mentolové cukríky	1 farba	14,852	13,757	12,783	11,870	11,322	10,591
90412.B		2 farby	15,035	13,939	12,965	12,052	11,443	10,713
90413.B		3 farby	15,217	14,122	13,148	12,235	11,565	10,835
90421.B	ovocný mix	1 farba	14,852	13,757	12,783	11,870	11,322	10,591
90422.B		2 farby	15,035	13,939	12,965	12,052	11,443	10,713
90423.B		3 farby	15,217	14,122	13,148	12,235	11,565	10,835
Technická príprava			65 €/farba					

Balenie: 5 kg vo vrecku



Reklamný cukor 4g v obale z bieleho lakovaného papiera – tvar „tuba“ (cena za ks)							
kód	popis tovaru	potlač	5 000 ks	10 000 ks	20 000 ks	35 000 ks	50 000 ks
90461.B	biely reklamný cukor – tuba	1 farba	0,046	0,030	0,029	0,023	0,021
90462.B		2 farby	0,048	0,032	0,030	0,024	0,022
90463.B		3 farby	0,050	0,033	0,032	0,025	0,023
Technická príprava			100 €/farba				

Balenie: 1000 ks



Reklamná čokoláda 5g (cena za ks)								
kód	popis tovaru	potlač	1 500 ks	3 000 ks	5 000 ks	10 000 ks	25 000 ks	50 000 ks
90441.B	mliečna čokoláda	1 farba	0,209	0,183	0,155	0,130	0,122	0,104
90442.B		2 farby	0,224	0,190	0,163	0,137	0,127	0,108
90443.B		3 farby	0,243	0,202	0,173	0,145	0,133	0,112
90451.B	horká čokoláda (min. 51% podiel kakaá)	1 farba	0,209	0,183	0,155	0,130	0,122	0,104
90452.B		2 farby	0,224	0,190	0,163	0,137	0,127	0,108
90453.B		3 farby	0,243	0,202	0,173	0,145	0,133	0,112
Technická príprava			52 €/farba					

Veľkosť: 31 x 31 x 5 mm

Balenie: voľne sypané – 500 ks kartón

Obal: Aluminiová fólia strieborná s prebalom z bieleho papiera (krieda lesk 90 g/m<sup>2</sup>)

Ďalší sortiment sladkej reklamy (napr. lízanky, čokolády, sušienky, žuvačky a pod.), rovnako ako iné varianty potlačí či balenia vám poskytneme na vyžiadanie.

Veľkosť: 92 x 39 x 6 mm (obal) / 61 x 33 x 6 mm (sušienka)

Balenie: voľne sypané – 250 ks kartón

Obal: fólia biela, metalizovaná či transparentná (typ obalu špecifikujte pri objednávke).

novinka

Reklamné sušienky 6g vo fólii-bielej, metalizovanej či transparentnej (cena za ks)								
kód	popis tovaru	potlač	1 500 ks	3 000 ks	5 000 ks	10 000 ks	25 000 ks	50 000 ks
90471.X	sušienka karamelová 6g	1 farba	0,230	0,143	0,122	0,109	0,096	0,083
90472.X		2 farby	0,239	0,148	0,126	0,113	0,100	0,087
90473.X		3 farby	0,252	0,157	0,130	0,117	0,104	0,091
Technická príprava			65 €/farba					



80290.B

Mätové cukríky v tvare auta

88 x 48 x 5 mm, cca 55 ks mentolových cukríkov  
tampoprint

novinka

ks	1-299	300+	1500+	3000+
€	0,730	0,700	0,674	0,657



80291.B

Mätové cukríky v tvare trička

70 x 75 x 5 mm,  
cca 55 ks mentolových cukríkov  
tampoprint

novinka

ks	1-199	200+	1000+	2000+
€	0,783	0,752	0,722	0,704

51193.TB



Mätové cukríky

77 x 47 x 5 mm, 6 g  
tampoprint

ks	1-199	200+	1000+	2000+
€	0,783	0,752	0,726	0,709



51201.TM

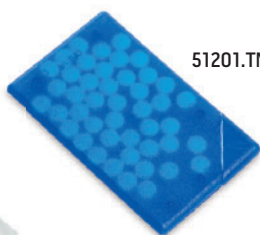

51205.T



51199.T

Čokoládové lentilky v plastovom  
stojančeku na vizitky v tvare tašky

104 x 61 x 37 mm, 60 g  
tampoprint

ks	1-99	100+	500+	1000+
€	2,039	1,965	1,896	1,848



51198.B

Mätové cukríky  
v dávkovači v tvare domčeka

71 x 63 x 5 mm, 6 g  
tampoprint

ks	1-199	200+	1000+	2000+
€	0,896	0,865	0,835	0,813



51190.B

Mätové cukríky bez cukru v boxe  
s praktickým stláčacím mechanizmom

80 x 48 x 8 mm, 10 g  
tampoprint

ks	1-299	300+	1500+	3000+
€	0,717	0,691	0,670	0,652



80293.R



Mätové cukríky  
v štvorcovom dávkovači

novinka

46 x 46 x 6 mm,  
cca 20 ks mentolových cukríkov  
tampoprint

ks	1-199	200+	1000+	2000+
€	0,826	0,796	0,761	0,743

80295.C



80294.M

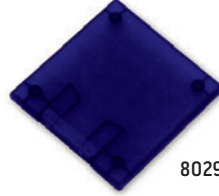

80292.B



51197.S



Mentolové cukríky v plechovej krabičke

61 x 49 x 17 mm, 28 g  
tampoprint, laserový popis

ks	1-129	130+	650+	1300+
€	1,552	1,491	1,439	1,404



51196.B



51195.Q

Čokoládové lentilky  
v sklenenej dóze

55 x 54 x 37 mm, 30 g  
tampoprint, laserový popis

ks	1-119	120+	600+	1200+
€	1,665	1,604	1,548	1,509

Sladké cukríky v plechovom  
boxe v tvare srdca

68 x 61 x 18 mm, 24 g  
tampoprint, laserový popis

ks	1-119	120+	600+	1200+
€	1,583	1,526	1,470	1,435

51208.B



51209.R



Mentolové cukríky bez cukru  
v plastovom boxe s kovovým viečkom

∅ 47 x 16 mm, 10 g  
tampoprint, laserový popis

ks	1-299	300+	1500+	3000+
€	0,748	0,722	0,696	0,678



51224.B

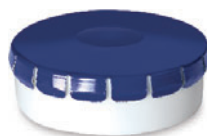

51222.M



51226.S



51223.R



Reklamné cukriky  
v kovovom boxe Clík Clák

Ø 45 mm  
tampoprint, laserový popis

od 0,765



Plnofarebná potlač už od 504 ks  
s dodacou lehotou cca 3 týždne,  
cena na dopyt.

voliteľné príchuťe	1. časť kódu
jahody	3986
citron a limetka	3987
tutti frutti	3988
silný mentol bez cukru	3989
mäta pieporná s cukrom	3990
mäta pieporná bez cukru	3991
extra silný mentol bez cukru	3992
<b>N</b> mentolové sladké drevko	3993
ovocný drops	3995
žuvačka	3996
čokoláda	3998
mint čokoláda	3999

Farby boxov – 2. časť kódu:

1.S (srieborná)	2.B (biela)
3.C (čierna)	4.I (tyrkysová)
5.M (modrá)	6.G (zlatá)
7.O (oranžová)	8.R (červená)
9.Z (zelená)	0.Y (žltá)

Reklamné cukriky Clík Clák	
počet kusov	39xxx.x
24 ks	1,604
504 ks	1,426
1008 ks	1,157
2016 ks	1,009
3024 ks	0,952
4032 ks	0,930
5040 ks	0,913
7560 ks	0,891
10080 ks	0,874
20160 ks	0,809
30240 ks	0,787
40320 ks	0,765

Zostavenie objednávacieho kódu:

Kód tvorí štvorčíslicie definujúce príchuť cukrika plus číslo a písmeno farby boxu.

Napríklad:

- príchuť čokolády v zlatom boxe = 39986.G
- príchuť ovocia v bielom boxe = 39952.B

Násobky 24 ks dodávame len v prevedení 39911.S – mäta pieporná, srieborný box. Ostatné verzie dodávame len v násobkoch balení 504 ks.

Maximálne rozpätie dodatočnej tampoprintovej dotlače do otvoru fólie je 25 mm. Celoplošná potlač je možná od 504 ks, je nutné ju aplikovať pred zatavením do ochranné fólie, teda už vo výrobe (dodacia doba cca 3 týždne). Trvanlivosť 1 rok od dátumu výroby.

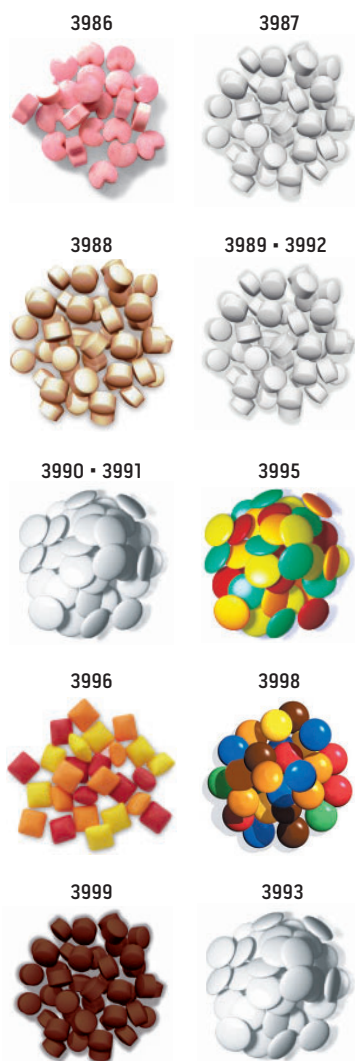

nová  
príchuť

Stlačením zhora otvor,  
Stlačením z boku uzavri

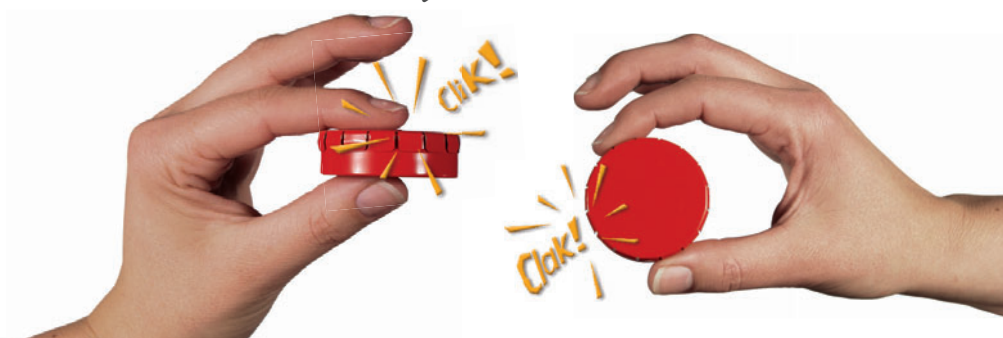



## Laserový popis

Označenie kovových i nekovových predmetov (z dreva, kože apod.) pomocou laserového lúča, výsledná farba loga je daná podkladovým materiálom predmetu.

Cenník reklamnej dekorácie laserom do kovu						
laser	do 4 cm <sup>2</sup>	do 8 cm <sup>2</sup>	do 12 cm <sup>2</sup>	do 16 cm <sup>2</sup>	do 20 cm <sup>2</sup>	každý ďalší cm <sup>2</sup>
1–99 ks	0,700	1,000	1,280	1,600	1,920	+0,060
100–499 ks	0,600	0,880	1,120	1,440	1,760	+0,060
500–999 ks	0,500	0,720	0,880	1,120	1,440	+0,060
1000 a viac ks	0,340	0,500	0,640	0,800	1,120	+0,060
kalenie	do 4 cm <sup>2</sup>	do 8 cm <sup>2</sup>	do 12 cm <sup>2</sup>	do 16 cm <sup>2</sup>	do 20 cm <sup>2</sup>	každý ďalší cm <sup>2</sup>
1–99 ks	0,900	1,320	1,600	2,080	2,400	+0,060
100–499 ks	0,800	1,200	1,440	1,880	2,200	+0,060
500–999 ks	0,640	0,960	1,200	1,480	1,800	+0,060
1000 a viac ks	0,440	0,680	0,840	1,080	1,400	+0,060

Technická príprava a nastavenie laseru: 12,00 €

Kalenie je možné len pri predmetoch z ocele a nerezú v hrúbke min. 3 mm, popis je čierny, povrch zostane hladký.

Pri dekorácii laserom rozhoduje o výslednej farbe podkladový materiál predmetu.

Cenník reklamného popisu laserom do nekovových predmetov							
počet kusov/plocha	do 4 cm <sup>2</sup>	do 8 cm <sup>2</sup>	do 12 cm <sup>2</sup>	do 16 cm <sup>2</sup>	do 20 cm <sup>2</sup>	do 30 cm <sup>2</sup>	do 50 cm <sup>2</sup>
1–99 ks	0,460	0,860	1,040	1,440	1,800	2,280	2,800
100–499 ks	0,400	0,760	0,960	1,280	1,600	2,000	2,560
500–999 ks	0,320	0,600	0,720	1,000	1,280	1,600	2,000
1000 a viac ks	0,220	0,420	0,520	0,720	0,920	1,120	1,400

Technická príprava a nastavenie laseru: 12,00 €

Prirážka pri lasere obdobných predmetov totožnou predlohou v jednej sérii: 5,- €/predmet.

## Tampoprint

Tlačí sa pomocou silikónového tampónu, ktorý prenáša farbu z tlačovej formy (štočku) na tlačný predmet. Vhodná technológia pre menšie predmety.

Cenník reklamnej potlače tampoprintom		
počet kusov/farieb	jedna farba	každá ďalšia farba
menej ako 100 ks	paušál 15,20 €	+11,20 €
100–199 ks	0,152	+0,112
200–299 ks	0,128	+0,088
300–499 ks	0,112	+0,080
500–999 ks	0,100	+0,072
1000–1999 ks	0,072	+0,060
2000–2999 ks	0,064	+0,052
3000–4999 ks	0,060	+0,048
5000–9999 ks	0,048	+0,040
10000 a viac ks	0,040	+0,032
Technická príprava	12,00 €	+12,00 €
Použitie dvojzložkovej farby	+0,020	+0,020

Podkladová tlač: pre tamponovú tlač farebných predmetov (najmä čiernych, modrých, zelených, žltých, červených a všetkých jej odtieňov) je pre dodržanie požadovaného odtieňa potlače nutné uskutočniť podkladovú tlač. Cena podkladovej tlače zodpovedá cene za druhú farbu, jej príprava nie je účtovaná.

Tampoprint farbami CMYK (foto, ...) účtujeme ako tlač piatimi farbami. Technická príprava je účtovaná ako pre štyri farby. Podklad musí byť biely, nie je možné tlačiť na povrch, ktorý vyžaduje použitie dvojzložkovej farby. Prirážka pri potlačí obdobných predmetov totožnou predlohou: +5,- € za každú zmenu predmetu násobené počtom farieb, prirážka za zmenu farby tlače pri potlačí rovnakého predmetu totožnou predlohou: +8,- €/farbu.



## Sieťotlač

Prenos farby pomocou šablóny priamo na tlačný plochý predmet.  
Rotačná sieťotlač sa používa pri potlačí valcových predmetov (hrnčeky, termosky).



Cenník reklamnej potlače sieťotlačou – plochy do 50 cm <sup>2</sup>		
počet kusov/farieb	jedna farba	každá ďalšia farba
menej ako 50 ks	<b>paušál 20,00 €</b>	<b>+16,00 €</b>
50–99 ks	0,400	+0,320
100–299 ks	0,360	+0,280
300–499 ks	0,320	+0,240
500–999 ks	0,280	+0,200
1000–2999 ks	0,200	+0,180
3000–4999 ks	0,180	+0,160
5000 a viac ks	0,160	+0,140
Technická príprava	13,20 €	+8,80 €

Cenník reklamnej potlače sieťotlačou – plochy do 150 cm <sup>2</sup>		
počet kusov/farieb	jedna farba	každá ďalšia farba
menej ako 50 ks	<b>paušál 24,00 €</b>	<b>+20,00 €</b>
50–99 ks	0,480	+0,400
100–299 ks	0,400	+0,360
300–499 ks	0,360	+0,300
500–999 ks	0,320	+0,260
1000–2999 ks	0,260	+0,220
3000–4999 ks	0,220	+0,180
5000 a viac ks	0,200	+0,160
Technická príprava	15,20 €	+11,20 €

Cenník reklamnej potlače sieťotlačou – plochy do 600 cm <sup>2</sup>		
počet kusov/farieb	jedna farba	každá ďalšia farba
menej ako 50 ks	<b>paušál 36,00 €</b>	<b>+24,00 €</b>
50–99 ks	0,720	+0,480
100–299 ks	0,600	+0,440
300–499 ks	0,520	+0,400
500–999 ks	0,440	+0,360
1000–2999 ks	0,360	+0,300
3000–4999 ks	0,300	+0,240
5000 a viac ks	0,240	+0,200
Technická príprava	17,60 €	+13,60 €

Cenník reklamnej potlače sieťotlačou – plochy do 1200 cm <sup>2</sup>		
počet kusov/farieb	jedna farba	každá ďalšia farba
menej ako 50 ks	<b>paušál 48,00 €</b>	<b>+32,00 €</b>
50–99 ks	0,960	+0,640
100–299 ks	0,840	+0,560
300–499 ks	0,720	+0,480
500–999 ks	0,640	+0,400
1000–2999 ks	0,600	+0,360
3000–4999 ks	0,480	+0,320
5000 a viac ks	0,400	+0,280
Technická príprava	19,60 €	+15,60 €



Cenník reklamnej potlače vybraných papierových výrobkov sieťotlačou – lišty na nástenné kalendáre, stolové kalendáre, novoročenky, papierové tašky do 200 cm <sup>2</sup> a krabice na víno		
počet kusov/farieb	jedna farba	každá ďalšia farba
menej ako 50 ks	<b>paušál 18 €</b>	<b>+ 16,30 €</b>
50–99 ks	0,367	+ 0,330
100–299 ks	0,327	+ 0,265
300–499 ks	0,286	+ 0,225
500–999 ks	0,265	+ 0,184
1000–2999 ks	0,204	+ 0,163
3000–4999 ks	0,163	+ 0,143
5000 a viac ks	0,163	+ 0,125
Technická príprava	13,50	+ 8,95

Cenník rotačnej sieťotlače – hrnčeky, termosky apod.		
počet kusov/farieb	jedna farba	každá ďalšia farba
menej ako 100 ks	<b>paušál 40,00 €</b>	<b>+32,00 €</b>
100–199 ks	0,400	0,320
200–299 ks	0,360	0,280
300–499 ks	0,320	0,240
500–699 ks	0,280	0,200
700–999 ks	0,240	0,160
1000–2999 ks	0,200	0,140
3000 a viac ks	0,160	0,120
Technická príprava	12,00 €	+12,00 €

Potlač stolových kalendárov sieťotlačou – pri potlačí oboch strán je účtovaný počet tlačí podľa tlačných plôch (tzn. 2 potlače pre 1 stolový kalendár)

Prirážka pri potlačí obdobných predmetov totožnou predlohou v jednej sérii: +5,- €/farba (platí pre všetky varianty sieťotlače)





## Transfer

Tlač sa uskutočňuje na prenosový papier, z ktorého je motív pomocou tepla a tlaku prenesený na tlačný materiál. Pomocou transferu vám natlačíme aj motívy presahujúce švy.

Cenník reklamnej potlače transferom – plochy do 50 cm <sup>2</sup>		
počet kusov/farieb	jedna farba	každá ďalšia farba
menej ako 50 ks	paušál 22,00 €	+18,00 €
50–99 ks	0,440	+0,360
100–299 ks	0,400	+0,320
300–499 ks	0,340	+0,280
500–999 ks	0,280	+0,220
1 000–2 999 ks	0,200	+0,180
3 000–4 999 ks	0,160	+0,160
5 000 a viac ks	0,140	+0,140
Technická príprava	16,00 €	+12,00 €

Cenník reklamnej potlače transferom – plochy do 150 cm <sup>2</sup>		
počet kusov/farieb	jedna farba	každá ďalšia farba
menej ako 50 ks	paušál 28,00 €	+22,00 €
50–99 ks	0,560	+0,440
100–299 ks	0,480	+0,380
300–499 ks	0,400	+0,300
500–999 ks	0,340	+0,260
1 000–2 999 ks	0,280	+0,220
3 000–4 999 ks	0,240	+0,180
5 000 a viac ks	0,200	+0,140
Technická príprava	18,00 €	+14,00 €

Cenník reklamnej potlače transferom – plochy do 600 cm <sup>2</sup>		
počet kusov/farieb	jedna farba	každá ďalšia farba
menej ako 50 ks	paušál 48,00 €	+24,00 €
50–99 ks	0,960	+0,480
100–299 ks	0,840	+0,440
300–499 ks	0,720	+0,400
500–999 ks	0,640	+0,360
1 000–2 999 ks	0,600	+0,300
3 000–4 999 ks	0,480	+0,240
5 000 a viac ks	0,400	+0,200
Technická príprava	20,00 €	+16,00 €

Cenník reklamnej potlače transferom – plochy do 1 200 cm <sup>2</sup>		
počet kusov/farieb	jedna farba	každá ďalšia farba
menej ako 50 ks	paušál 56,00 €	+32,00 €
50–99 ks	1,120	+0,640
100–299 ks	1,000	+0,560
300–499 ks	0,880	+0,480
500–999 ks	0,780	+0,400
1 000–2 999 ks	0,680	+0,360
3 000–4 999 ks	0,600	+0,320
5 000 a viac ks	0,520	+0,280
Technická príprava	22,00 €	+18,00 €

Prirážka pri potlačí obdobných predmetov totožnou predlohou v jednej sérii: 5,- €/farba.  
Transfer a sietotlač farbami CMYK Vám radi individuálne vykalkulujeme.



## Výšivka

Strojové vyšívacie loga podľa vytvoreného vyšívacieho programu pomocou vyšívacieho stroja a vyšívacieho rámčeka. Výška písmena vhodného pre vyšívku je min. 5 mm.

Cenník výšivky (tričká, čiapky, bundy, uteráky, ...)								
rozmer	do 4 cm <sup>2</sup>	do 8 cm <sup>2</sup>	do 12 cm <sup>2</sup>	do 16 cm <sup>2</sup>	do 20 cm <sup>2</sup>	do 30 cm <sup>2</sup>	do 50 cm <sup>2</sup>	za každý cm <sup>2</sup> nad 50 cm <sup>2</sup>
Cena za vyšitie a finalizáciu, od 1 ks	0,760	0,880	1,000	1,120	1,280	1,440	1,760	+0,036
Technická príprava vrátane programovania	16,00 €	19,20 €	22,00 €	24,00 €	28,00 €	36,00 €	48,00 €	bez prirážky

Úprava existujúceho vzoru (preprogramovanie na inú veľkosť): +8 €.

Pri opakovaní objednávky rovnakou veľkosťou na rovnaký predmet, pri zmene vyšívacieho predmetu alebo farby nite sa už účtuje len 10 % hodnoty technickej prípravy výroby.

Ceny platia pre vyšívacie vysokokvalitnými niťami SULKY®, výroba Gunold Nemecko.



## Plnofarebná dotlač

Cenník plnofarebnej dotlače kalendárov a obálok (ofset, prípadne tlač pigmentovými atramentami)	
<b>ofsetová tlač kalendárov 62701 tlač všetkých 4 plôch súčasne</b>	
menej ako 200 ks	<b>paušál 285 €</b>
200–299 ks	<b>1,429</b>
300–499 ks	<b>1,020</b>
500–999 ks	<b>0,612</b>
1000 a viac ks	<b>0,367</b>
<b>digitálna tlač kalendárov 62701 a obálok 62702</b>	
1–20 ks	<b>100</b>
nad 20 ks	<b>+ 1,46 €/ks</b>
<b>digitálna tlač viacmesačných kalendárov 62710–62718</b>	
menej ako 50 ks	<b>paušál 90 €</b>
51–100 ks	<b>1,776</b>
101–200 ks	<b>1,653</b>
201–500 ks	<b>1,531</b>
<b>digitálna tlač stolových kalendárov-dig. tlač na obe strany</b>	
menej ako 50 ks	<b>paušál 60 €</b>
51–100 ks	<b>1,163</b>
101–200 ks	<b>1,102</b>
201–500 ks	<b>1,041</b>
<b>digitálna tlač nástenných kalendárov do rozmeru lišty 340 x 70 mm</b>	
menej ako 50 ks	<b>paušál 65 €</b>
51–100 ks	<b>1,286</b>
101–200 ks	<b>1,163</b>
201–500 ks	<b>1,102</b>
<b>digitálna tlač nástenných kalendárov do rozmeru lišty 490 x 70 mm</b>	
menej ako 50 ks	<b>paušál 78 €</b>
51–100 ks	<b>1,531</b>
101–200 ks	<b>1,408</b>
201–500 ks	<b>1,347</b>
<b>digitálna tlač nástenných kalendárov do rozmeru lišty 630 x 70 mm</b>	
menej ako 50 ks	<b>paušál 90 €</b>
51–100 ks	<b>1,776</b>
101–200 ks	<b>1,653</b>
201–500 ks	<b>1,592</b>
Technická príprava plnofarebnej dotlače	<b>16 €/CMYK</b>



Plnofarebnú tlač na viac ako 500 ks kalendárov Vám vykalkulujeme  
 Pri trojmesačných SKLADACÍCH MAXI kalendároch 62701 sú tlačené všetky štyri reklamné plochy súčasne, je možné tlačiť i na spad.  
 Pre nástenné a stolové kalendáre je plnofarebná dotlač riešená samolepkou (digitálna tlač).

Cenník plnofarebnej dotlače novoročieniek	
počet kusov	cena v €/ks
1–99	<b>0,32</b>
100+	<b>0,28</b>
300+	<b>0,24</b>
1000+	<b>0,20</b>
Technická príprava (bez ohľadu na počet farieb)	<b>16,00 €</b>

Digitálna dotlač novoročieniek špeciálnymi pigmentovými atramentami je plnohodnotnou alternatívou ku klasickým metódam razby a sietotlače. Na novoročenky tak idú dotlačiť reklamné texty a logo podľa vlastnej dodanej grafickej predlohy. Cena potlače za kus platí pre ľubovoľnú súťaž farieb okrem striebornej, zlatej a bielej farby.

## Razba

Na aplikáciu loga na predmet (väčšinou z kože a koženky) dochádza pomocou raznice (doporučujeme kvalitnú mosadznú raznicu), ktorej motív je za vhodnej teploty a tlaku vyrazený do predmetu.

Cenník razby do kože a koženky, razba diárov, novoročieniek		
počet kusov	tepelná razba slepotlačou (diäre)	tepelná razba cez fóliu (novoročenky)
menej ako 50 ks	<b>paušál 20,00 €</b>	<b>paušál 26,00 €</b>
50–99 ks	<b>0,400</b>	<b>0,520</b>
100–299 ks	<b>0,320</b>	<b>0,440</b>
300–499 ks	<b>0,240</b>	<b>0,360</b>
500–999 ks	<b>0,220</b>	<b>0,340</b>
1000 a viac ks	<b>0,200</b>	<b>0,320</b>
Technická príprava a výroba raznice (cena sa môže líšiť pri veľmi zložitej predlohe)	<b>od 48,00 €/mosadz</b>	

Nastavenie stroja pri razbe rovnakou predlohou v jednej sérii: +5 €/predmet.



Sietotlač a transfer farbami CMYK vám individuálne vykalkulujeme. Diäre tlačené sietotlačou sú vždy účtované ako sietotlač do plochy 50 cm<sup>2</sup>, bez ohľadu na veľkosť predlohy.

Prvú korektúru posielame na odsúhlasenie zdarma, je v cene tlače. Druhú a ďalšie korektúry vyvolané doplnením, upresnením či zmenou zadania účtujeme paušálnou sadzbou 4,80 € za predmet plus hodnotou grafickej práce podľa hodinovej sadzby. Za spracovanie návrhu rôznych variant potlačí na predmet účtujeme 4,80 € za variant.

Grafické práce na vašich podkladoch (tvorba a úprava loga...) účtujeme hodinovou sadzbou 20,- €.

Expresnú tlač (do 10 pracovných dní) realizujeme po dohode s prirážkou 20 až 100% podľa obdobia.

Individuálne vybalovanie a balenie kusovo baleného tovaru: jednotlivo balené písacie potreby +0,04 €/kus, sady pier a ostatný tovar +0,06 €/kus, tričká do sáčkov s výstuhou +0,12 €/kus, demontáž nástenných hodín pri tlači na ciferník +0,16 €/kus.

Potlač na predmety dodané zákazníkom realizujeme po dohode s prirážkou 30%, bez záruky vhodnosti použitých farieb na dodaný materiál.

Zhotovené predlohy, sitá, raznice, klišé a programy zostávajú majetkom dodávateľa. Pre opakované použitie nie sú archivované, pokiaľ nie je uvedené inak.

Výrobu a potlač tašiek z PVC a mikroténu, samolepiacich lístkov, samolepiek a ďalšie individuálne zákazky vám na vyžiadanie radi vykalkulujeme.

Dodávateľ si vyhradzuje právo dodať a účtovať +/- 5% z objednaného počtu kusov s potlačou.

druh tovaru	strana
aktovky	222-223
alkoholtestery	137
antistresové predmety	89, 144
aróma sady	239, 246-247
auto príslušenstvo	136-138, 210
balzamy na pery	235
baseballové čiapky	183-186
baterie	134
baterky	96-97, 105, 107, 118, 132-135, 137, 151, 194, 254
bezpečnostné, reflexné vesty	138, 147
bicykle a príslušenstvo	137-139
blikačky - bezpečnostné odrazky	135
bloky poznámkové, zápisníky	84-87, 119, 220-221, 242
brúška na nože	251
bublifuky	146
budíky	82, 123-127
bundy	172-174, 176-181
CD	37, 233, 246
ceruzky	80, 146
cestovné doplnky	210-215, 233, 241
cestovné puzdra a obaly	210-211, 233
cestovné vankúšiky	211
clik-clak	284
cukríky	281-284
cukríky	281
čaj, čajové súpravy	247, 255, 262
čelovky	135
čiapky	183-188
čističe na mobil/iPad	90-91, 222
čističe na okuliare	90
čokoláda	246, 281-284
ďalekohľady	151
dáždniky - pevné	195-199
dáždniky - skladacie	190-194
deky	153, 247, 252
detské darčeky	138, 144-150, 185
diáre	29-33, 221
dokladovky	210, 225, 233
držiačky na tašky	242
držiačky na telefóny	83, 101, 125
fandiace darčeky	156-157
fény	241
fľaša na nápoje - kov	262, 266-267
fľaša na nápoje - plast	155
fľašky	95, 269-271
flisové bundy	172-174, 179
frisbee	156
golf	16, 89, 152
grilovanie	252-254, 273
hlavolamy	145-147
hodinky - náramkové	128-129
hodiny - nástenné	24-25, 130-131
hodiny - stolové	25, 124-127
hračky	144-147, 156
hrnčeky - frosty	260
hrnčeky - keramické	255, 262-265
hrnčeky - kovové	266-267
hrnčeky - porcelánové	262
hry - stolové	148-150
hry - vonkajšie	150, 152
chladiace nádoby	258
jo-jo plastové/drevené	145-146
kalendáre - nástenné	2-20, 24-27
kalendáre - obaly	28
kalendáre - pracovné	22, 25-28
kalendáre - s hodinami	24-25
kalendáre - stolové	19, 21-23, 25
kalendáre - viacmesačné	26-27
kalkulačky	119-121, 220-221
karafy	261
karty	148-149
klobúky	182-183
kľúčenky	79, 92-100, 105, 147, 232, 240, 242
kompasy	151
kozmetické sady	235, 239
kozmetické tašky	241
krabice na víno	203
krabička na lieky	240
krabičky na perá	71
kravaty	238
krokometry	154
kuchynňa - doplnky	248-252, 255-267

kuchynské nože	250-251
kúpeňové sady	239
ľadvinčky, cestovné taštičky	210
lampičky - LED svetlo	118
laserová ukazovadlá	118
lékárníčky	240
lepíacie lístky	86-87
lietajúce taniere	156
lopty - antistresové	144
lopty - pláňové nafukovacie	156
lupy	83, 89, 107
manikúry	243-245
manžetové gombíky	238
mapy A4, A5, A6	220-222
masážne kamene	239
mechanické ceruzky	38, 46, 58-59, 66-67, 70-72, 74, 81
memory klip	83
meracie telesného tuku	154
meteoštanice, teploměry	122-124, 126-127, 131, 240
metre	140, 142-143
mikiny	170-174
mikrovláknové utierky a čističe	90
minútky	248
mlynčeky na korenie a soľ, bylinky	249
mydlá a dezinfekčné gély	239
nafukovacie výrobky	156, 211
nákupeňé košíky	206
náradie	107, 138-141
náramky	240
novoročenky - jednodielne	34-35
novoročenky - viacdielne	36-37
nože	101-111, 151, 250-251
nože - brúsky	251
obaly na telefóny	91, 101
obaly na CD/DVD	233
obaly na diáre	28
obaly na hrnčeky	264
obaly na iPad	91, 222
obaly na kalendáre	28
obaly na obleky	211
obaly na perá	71
obaly na uteráky, osušky	236
okuliare	234
opasok	238
orezávač cigár	272
otvárač listov	83, 107
otvárače	100-103, 106, 108-111, 139, 248, 256-259, 277
palice na nordic walking	154
panákovky	260
parfumové rozprašovače	235
pastelky	146
PC príslušenstvo	118-119
peňaženky - dámske	227, 231-232
peňaženky - darčekové sady	224
peňaženky - kožené	226-232
peňaženky - koženkové	224-225, 227, 232
peňaženky - pánske	224-226, 228-230, 232
perá - drevené	80-81
perá - gélové	59
perá - guľičkové	48-81
perá - kovové	38-47, 57, 59-79
perá - krabičky a papier, puzdra	71
perá - multifunkčné	66-67
perá - Parker	38-45
perá - plastové	48-59, 62, 66, 70, 74, 82, 147
perá - plniace	41, 43, 47, 76
perá - Quill, Lamy, Waterman, Balmain	46-47, 64, 78-79
perá - Rotring	62, 71, 74
perá - sady	38, 46, 70, 72-76, 78-79, 81
petanque	152
pičnik - deky, tašky	153, 206, 252, 254
písacie podložky	87
píšťalky	99, 145
podložky - pod myš	119
podložky - sedacie	157
podložky na krájanie	250
poháre	260-261
pokladničky	145
polokošeľa	165-170
popolníky	272

poznámkové bloky	84-87, 119, 220-221, 242
pravítka	83, 107, 145
prístroje	258
príslušenstvo k PC	118-119
prívesky	79, 92-100, 105, 112, 114, 117-118, 134, 142-144, 147, 189, 224, 240, 272
pršíplášte a ponča	189-190
prvá pomoc	240
puzdra na cestovné doklady	210, 233
puzdra na iPad	91
puzdra na telefóny	91, 101
reflexné produkty	135, 138, 147, 206, 279
relaxačná hudba	246
reproduktory	119
rezače	143
rollery	39-43, 47, 60, 66-67, 72-79
rozlíšovací dresy	155
rukavice	136, 156, 187-188
rúksaky	147, 190, 206, 208-209
slúchadlá	99
spisovky	220-222
stojany na iPad	91
stojany na mobilný telefón	83, 125
stojany na perá	75, 81-82, 89
stylus	58, 65, 67, 83, 91, 116, 118
sviečky	246-247
Swarovski	77
Swisscard	107
šále	187-188
šálky na kávu	255, 262, 267
šatky	182
šitie	241
škrabky na ľad	136
škrabky na ovocie a zeleninu	250
šnúry na krk	278-280
šnúry rolovacie	279
športové fľaše	155, 262
švihadlá	154
tašky - do ruky	216-219, 224
tašky - konferenčné	216-219
tašky - kozmetické	241
tašky - na notebook	216
tašky - na obuv	211
tašky - na víno	203
tašky - nákupné	204-207
tašky - papierové	200-203
tašky - športové a cestovné	138, 204, 210, 212-215
tašky na dokumenty	217
ťažítka	89
teplomery	82, 122-124, 126-127, 131, 240
termohrnčeky, termokanvičky	266-267
termosky	268
termotašky	254
tesárske ceruzky	80
toaletné tašky	241
tríčka	158-164
USB kľúč	108, 112-117
uteráky, osušky	155, 236-237
utierky na okuliare	90
váha na batožinu	211
vesty	138, 147, 175
vešniak na kravaty	238
vianočné CD	37
Victorinox	107-111, 129, 138, 250-251
vinne sady	256-259, 261
vino - doplnky	101, 106, 250, 256-259, 261
vizitkáre	88-89
vlhčené vreckovky	234
voskovky	146
vreckové a multifunkčné nože	101-111, 151
vreckovky	234
vývrtky	101-103, 106, 108-111, 256-259
záhradnícke nožnice	139
zapaľovače - kovové	95, 272-275
zapaľovače - krbové	273
zapaľovače - plastové	272, 275-277
zásobník na lieky	240
zásobníky na papiere	86
zástery	252
zrkadielka	242-243
župany	235

